

## BROADBAND DISTRIBUTED AMPLIFIER

## ADM-0026-5929SM

The ADM-0026-5929SM is a broadband, efficient GaAs PHEMT distributed amplifier in a 4mm QFN surface mount package. It is designed to provide optimal LO drive for T3 mixers and offers 13 dB typical gain and 20 dBm typical saturated output power for 165 mA of current. Extended high frequency gain offers improved harmonic generation and rise times improving T3 linearity. The ADM-0026-5929SM is biased with a 5-7 volt positive bias and an optional current reducing negative voltage with external bias tee. Additional applications include clock signals and other general purpose driver applications in electronic warfare and test and measurement. The ADM-0026-5929SM is an excellent alternative to competing GaAs PHEMT distributed amplifiers.

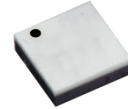

### Features

- Optimized for use as a [T3 LO buffer amplifier](#)
- Fast <10 ps risetime
- 3<sup>rd</sup> and 5<sup>th</sup> Harmonic Generation
- Broadband 50  $\Omega$  Matching
- Unconditionally Stable

### Electrical Specifications - Specifications measured in a 50-Ohm system.

| Parameter  | Frequency<br>(GHz) | Min | Typ | Max        |  |
|--|--------------------|-----|-----|------------|--|
| Input for Saturated Output (dBm)   | DC to 26.5         | +5  | +10 | +12        |  |
| Output 1 dB Compression (dBm)  |                    |     | +15 |            |  |
| Saturated Output Power with negative bias (dBm)  |                    |     |     | +20        |  |
| Small Signal Gain with negative bias (dB)  |                    |     |     | 13         |  |
| Return Loss (dB)   |                    |     |     | 14         |  |
| Noise Figure (dB)  |                    |     |     | 5.5        |  |
| Third Order Output Intercept Point (dBm)   |                    |     |     | 26         |  |
| Bias Requirements, External (mA)<br>Vd: +5.0 to +7.0 / Vg: -0.25 Volts<br>Vd: +5.0 to +7.0 / Vg: 0 Volts |                    |     |     | 165<br>225 |  |

### Part Number Options

| Model Number                 | Description                      |
|------------------------------|----------------------------------|
| ADM-0026-5929SM <sup>1</sup> | Surface Mount 4mm QFN            |
| EVAL-ADM-5929SM              | Connectorized Evaluation Fixture |

<sup>1</sup> Note: For port locations and I/O designations, refer to the drawings on page 2, 8, and 9 of this document.

***GaAs MMIC devices are susceptible to Electrostatic Discharge. Use proper ESD precautions when handling these items.***

# BROADBAND DISTRIBUTED AMPLIFIER

**ADM-0026-5929SM**

Page 2

Frequency DC to 26.5 GHz

Functional Diagram and Application Circuit

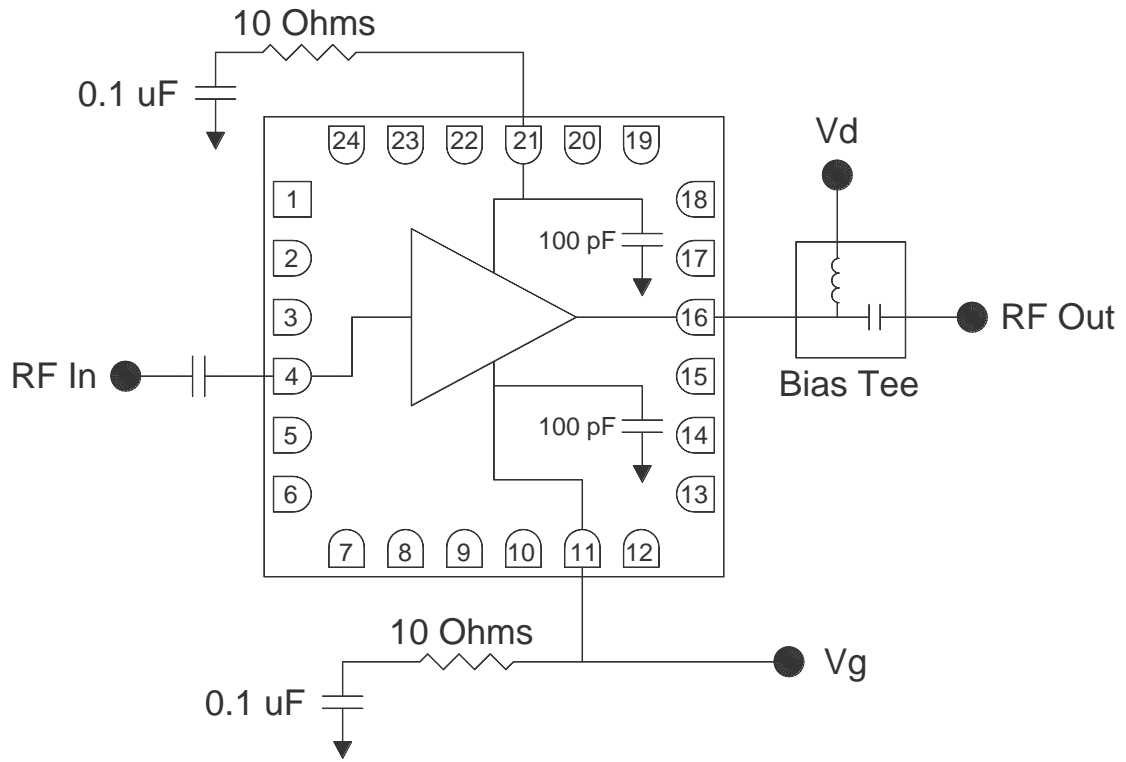

### Biasing and Operation

**RF In / RF Out** – Input and output signals should be connected by 50 ohm microstrip or coplanar traces to well matched 50 ohm sources and loads. DC blocking capacitors and bias tees are required.

**Vg** – Negative gate voltage is optional, the amplifier can operate with positive bias only. Application of a negative bias between 0 and -0.3V will reduce current consumption, improve even harmonic suppression, and potentially improve T3 linearity. Reduced current consumption can also lead to increased amplifier lifetime. The amplifier is designed for optimal performance when the negative gate voltage is tuned such that current drawn from the *positive* bias supply is 112 mA. It may be supplied through pin 11 or through the RF input on pin 4.

**Vd**- Bias supply supplied to Vd through pin 16 should be voltage limited below 9 V and current limited below 275 mA at all times. The operational bias voltage should be between 5 V and 7 V for full gain, efficiency, and linearity. In general gain, linearity, and output power will increase marginally with increased voltage from 5 to 7 V.

**Optional Bias Circuitry** – The resistor and capacitor on the Vd and Vg lines (pads 21 and 11) prevent low frequency oscillation. These components are not required in bias circuits with sufficient low frequency loss. Designers should experiment to determine if they are necessary.

**DC/RF Ground** – The ground paddle of the QFN should be connected to a low noise RF and DC ground with very low electrical and thermal resistance for high frequency operation and thermal heat sinking.

**BROADBAND DISTRIBUTED AMPLIFIER**

**ADM-0026-5929SM**

Page 3

Frequency DC to 26.5 GHz

Typical Performance: Positive Only (+3 to +7V) Bias (Pin 16 Output), Grounded Gate (Pin 11)

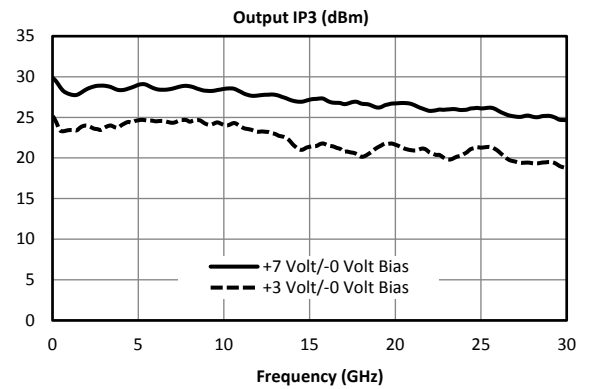
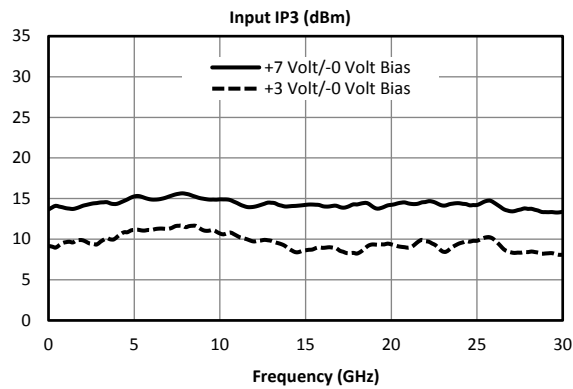
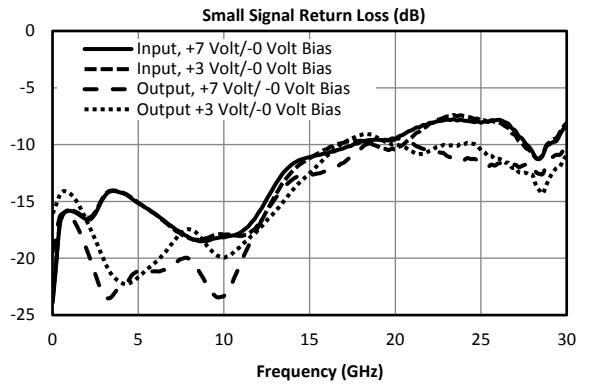
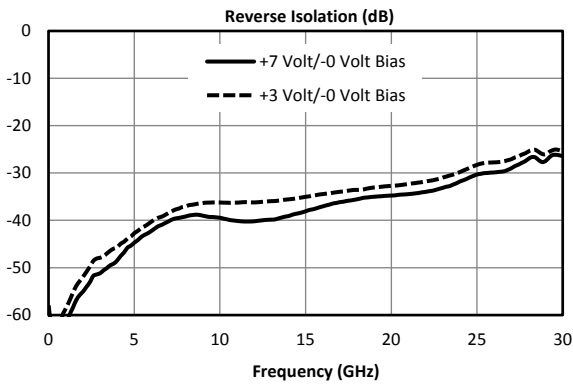
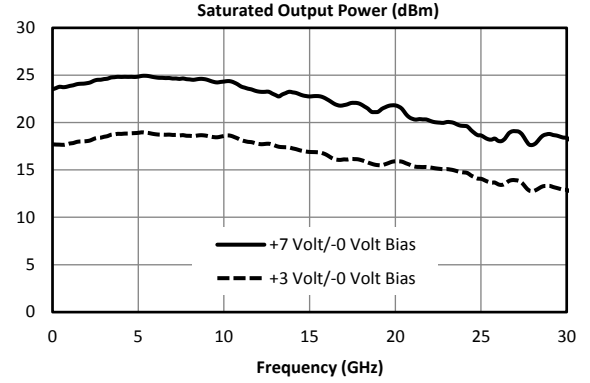
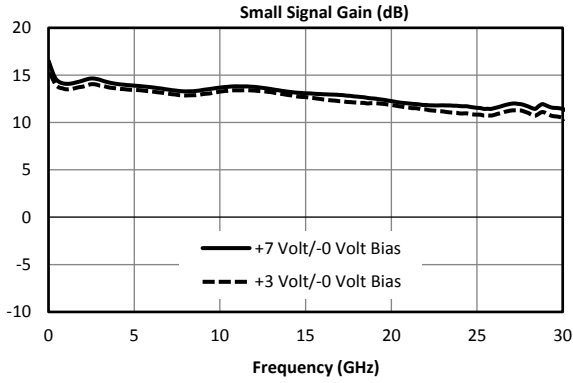

# BROADBAND DISTRIBUTED AMPLIFIER

# ADM-0026-5929SM

Page 4

Frequency DC to 26.5 GHz

Typical Performance: Positive Only (+3 to +7V) Bias (Pin 16 Output), Grounded Gate (Pin 11), continued

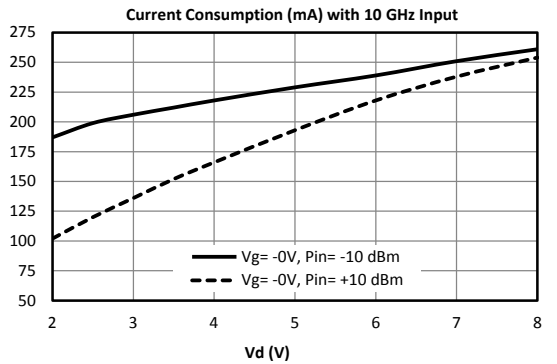
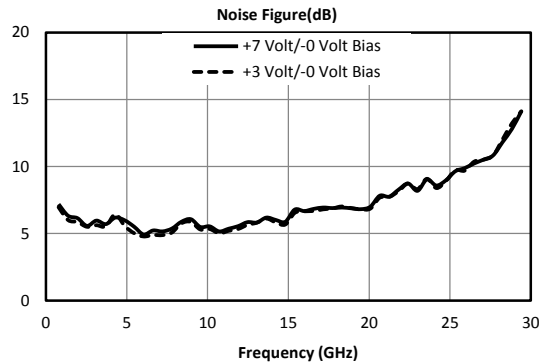
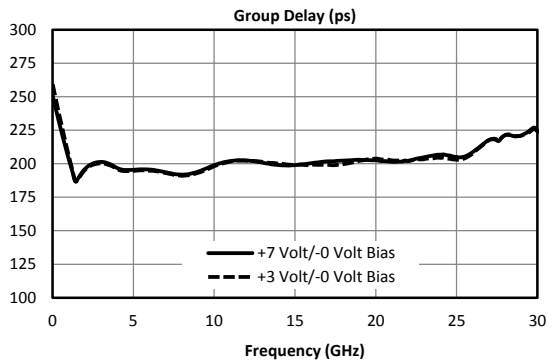
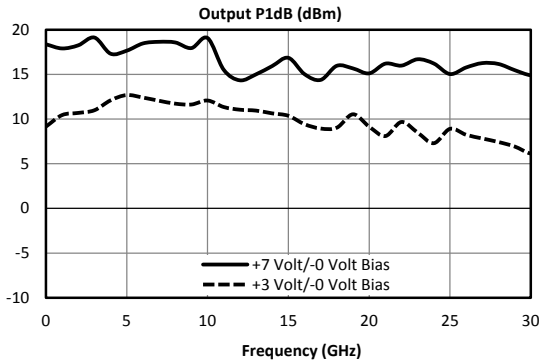
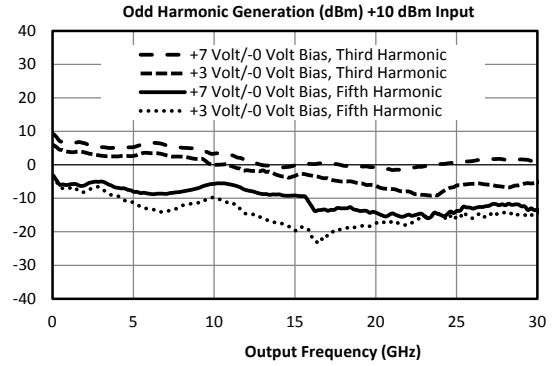
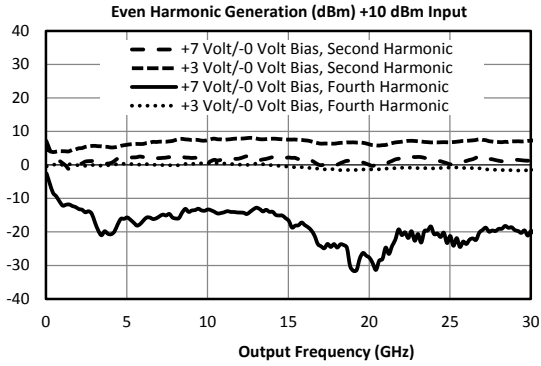

# BROADBAND DISTRIBUTED AMPLIFIER

# ADM-0026-5929SM

Page 5

Frequency DC to 26.5 GHz

Typical Performance: +5 to +7V Positive Bias (Pin 16 Output), -.25 Negative Bias (Pin11)

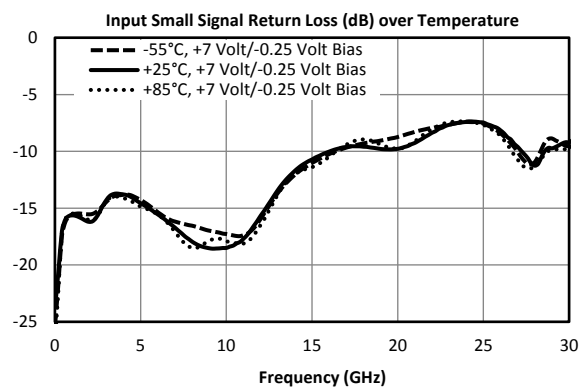
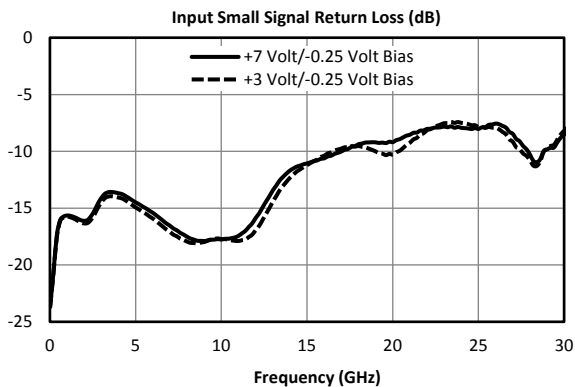
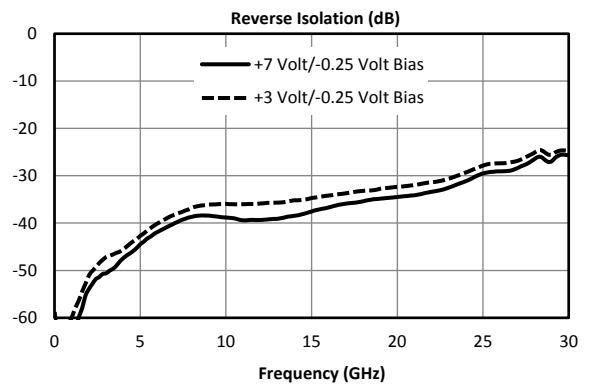
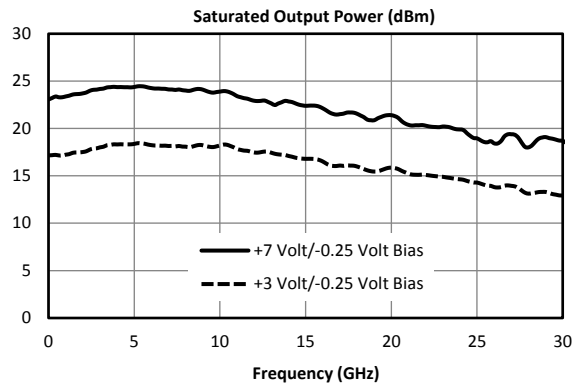
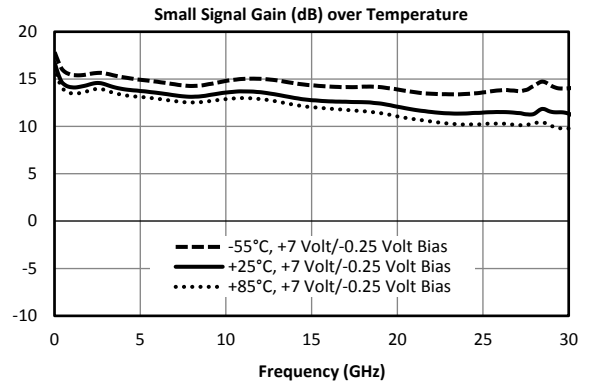
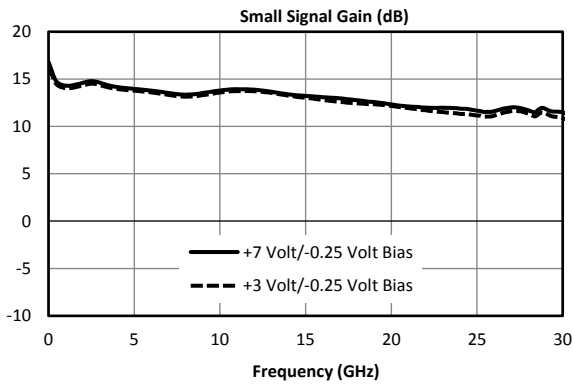

# BROADBAND DISTRIBUTED AMPLIFIER

# ADM-0026-5929SM

Page 6

Frequency DC to 26.5 GHz

Typical Performance: +5 to +7V Positive Bias (Pin 16 Output), -.25 Negative Bias (Pin11)

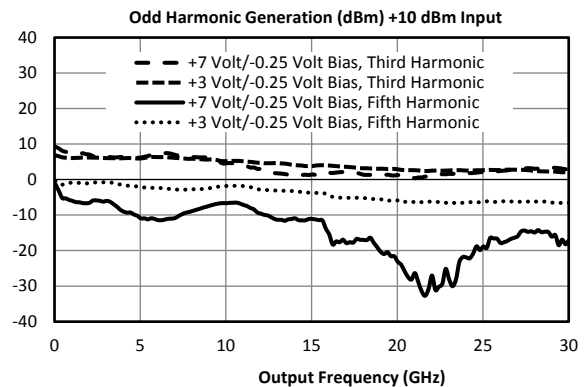
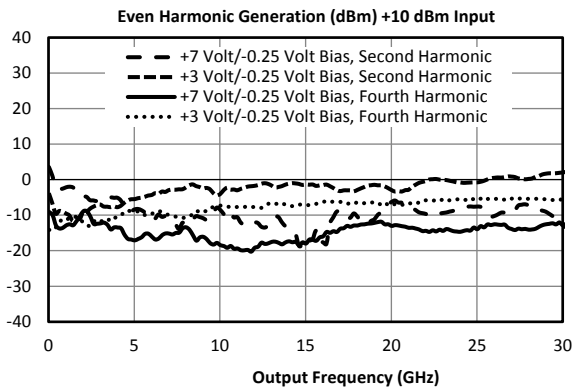
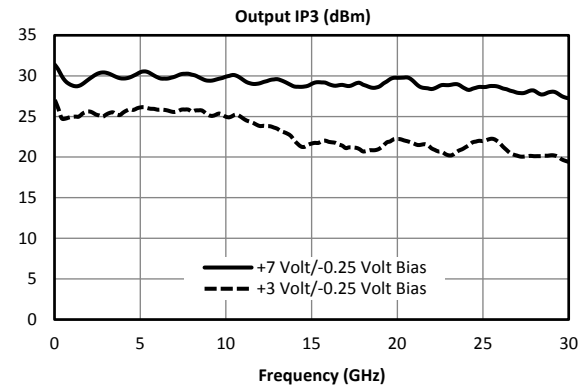
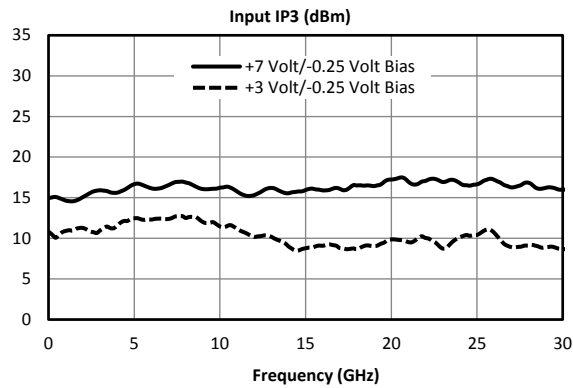
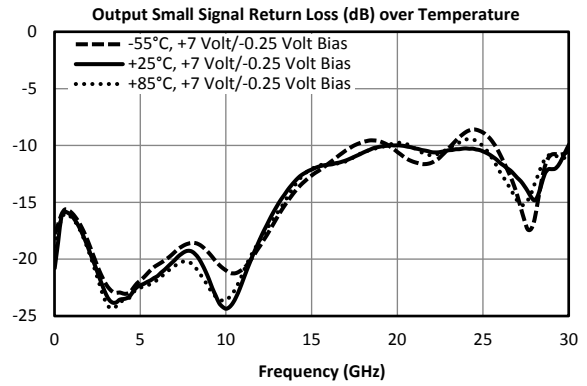
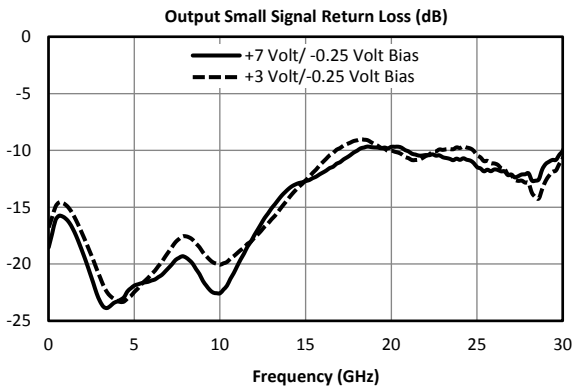

# BROADBAND DISTRIBUTED AMPLIFIER

Page 7

# ADM-0026-5929SM

Frequency DC to 26.5 GHz

Typical Performance: +5 to +7V External Bias (Pin 16 Output), -0.25V Negative Bias (Pin11) continued

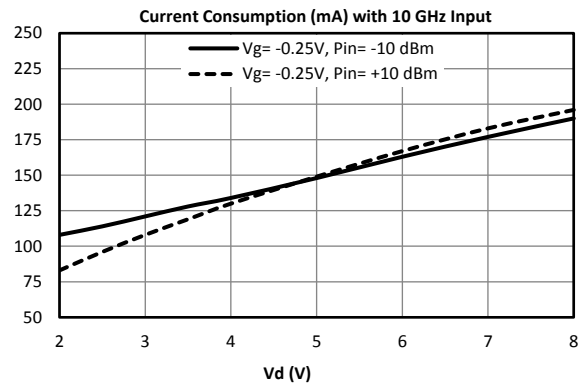
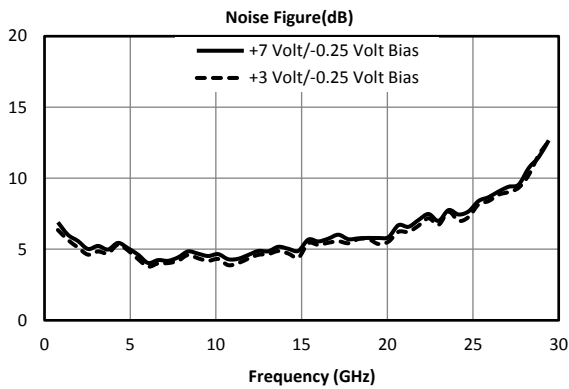
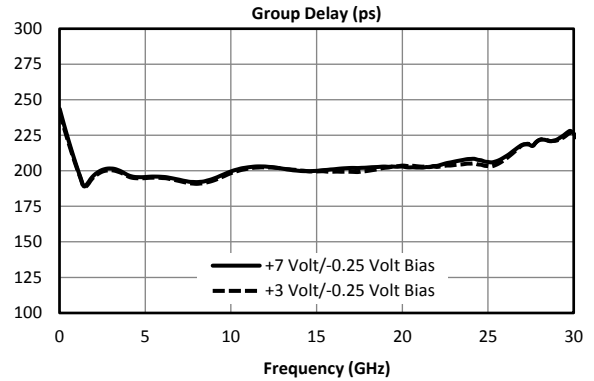
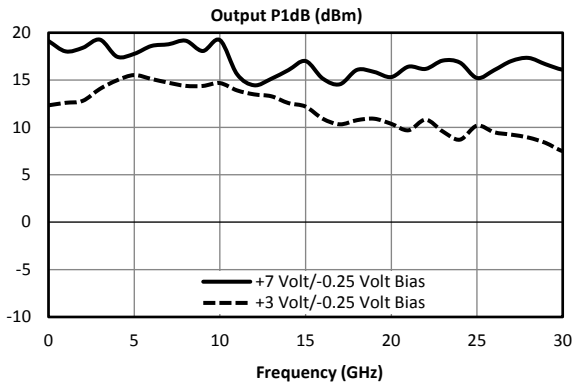

# BROADBAND DISTRIBUTED AMPLIFIER

# ADM-0026-5929SM

Page 8

Frequency DC to 26.5 GHz

Outline Drawing

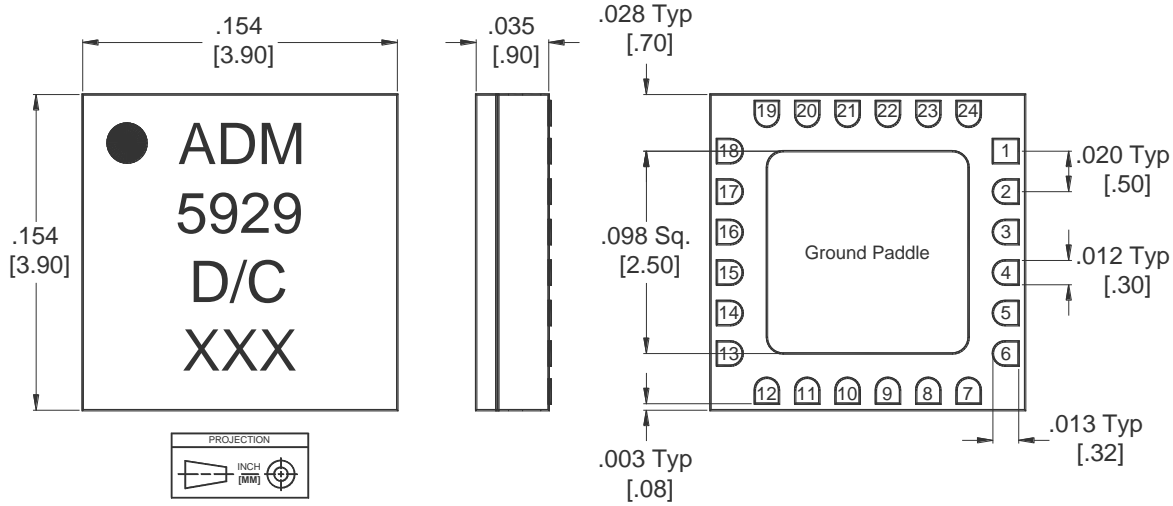

Substrate material is Ceramic.

I/O Leads and Ground Paddle are 1.4±0.6 microns (55±24 micro-inches) Au over 1.3 microns (51 micro-inches) Ni.

All unconnected pads should be connected to PCB RF ground.

PCB Footprint Drawing

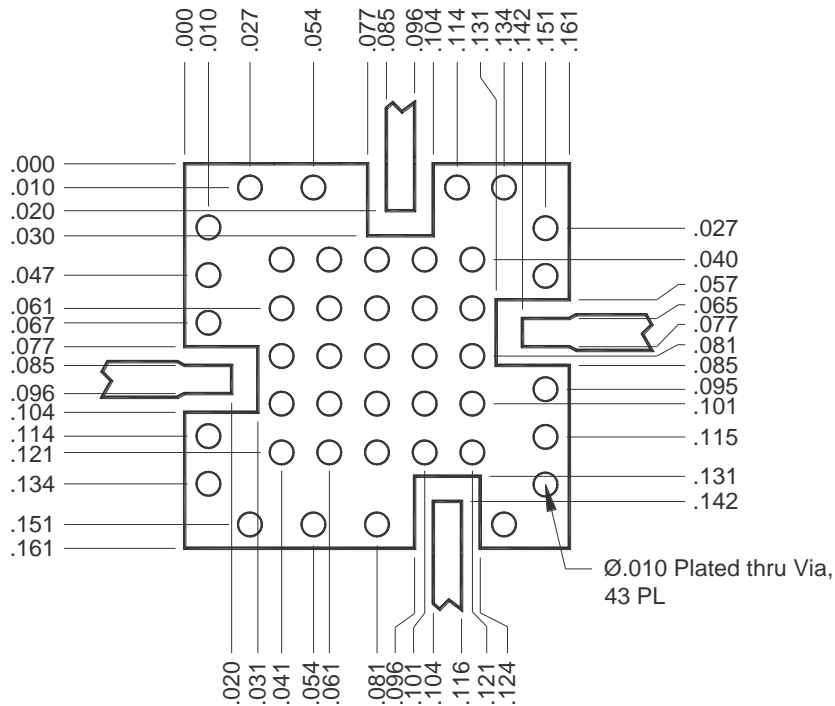

QFN-Package Surface-Mount Landing Pattern

[Click here for a DXF of the above layout.](#)

[Click here for leaded solder reflow.](#) [Click here for lead-free solder reflow.](#)







# BROADBAND DISTRIBUTED AMPLIFIER

**ADM-0026-5929SM**

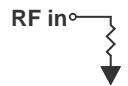
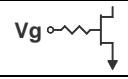
Page 9

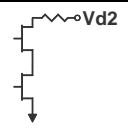
Frequency DC to 26.5 GHz

| Pin Descriptions                |             |   |   |
|---------------------------------|-------------|---|---|
| Pin Number                      | Function    | Description   | Interface Schematic   |
| 1-3, 5-10, 12-15, 17-20, 22, 24 | NC          | These pins are not connected internally. Datasheet performance is tested with NC pins grounded. |   |
| 4                               | RF in       | This pin is DC coupled and matched to 50 Ω.   |    |
| 11                              | Vg          | Gate control for the amplifier. External decoupling resistor/capacitor is required.             |    |
| 16                              | RF out / Vd | This pad is DC coupled and matched to 50 Ω.   |    |
| 21                              | Vd2         | External decoupling resistor/capacitor is required.   |   |
| Paddle                          | GND         | Ground pad should be connected to RF/DC ground with low electrical and thermal resistance.      |  |

| Absolute Maximum Ratings          |                 |
|-----------------------------------|-----------------|
| Parameter                         | Maximum Rating  |
| Positive Bias Voltage             | 9 V             |
| Positive Bias Current             | 275 mA          |
| Negative Bias Voltage             | -2 V            |
| Negative Bias Current             | 2 mA            |
| RF Input Power                    | +20 dBm         |
| Power Dissipation                 | 2 W             |
| Thermal Resistance, $\theta_{jc}$ | 0.873 C/W       |
| ESD (Human Body Model)            | Class 0         |
| Operating Temperature             | -55°C to +85°C  |
| Storage Temperature               | -65°C to +150°C |

**BROADBAND DISTRIBUTED AMPLIFIER**

**ADM-0026-5929SM**

Page 10

Frequency DC to 26.5 GHz

Evaluation Board

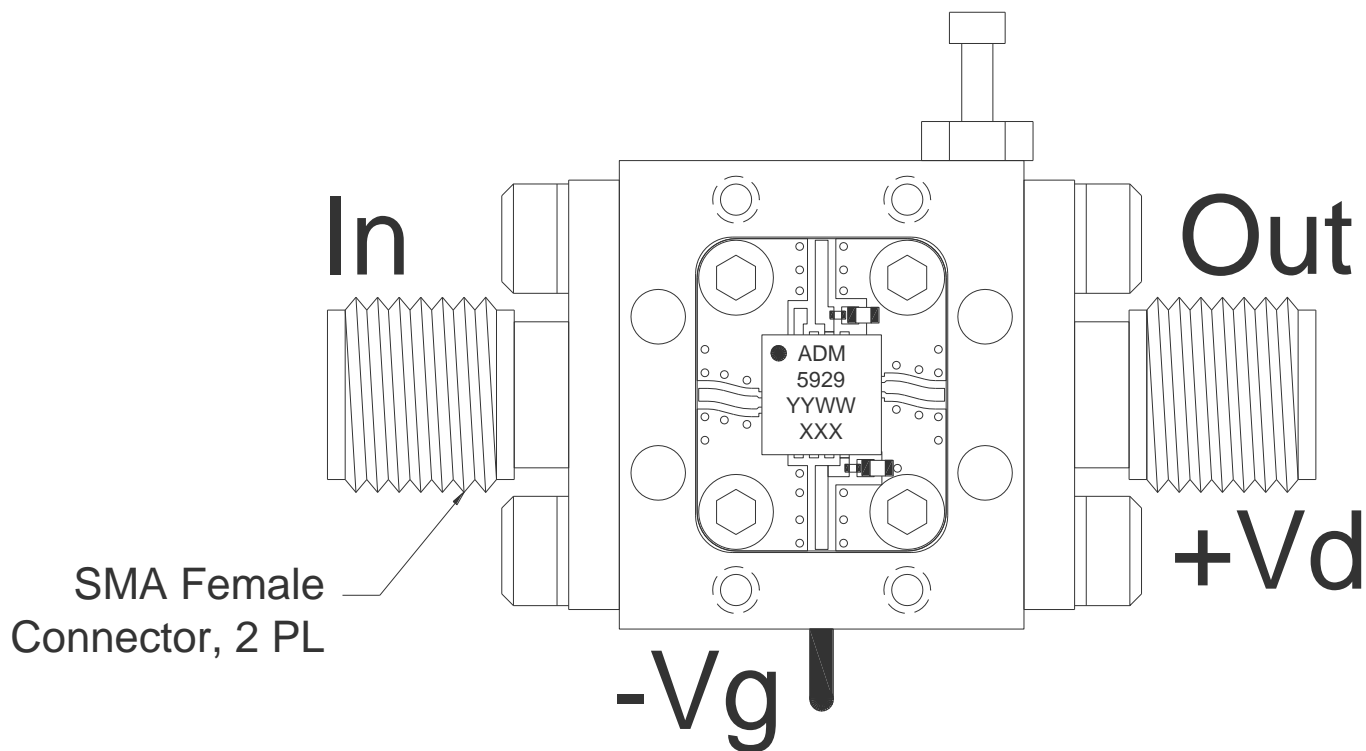

The evaluation module follows Marki standard assembly and evaluation procedures to give optimal performance for datasheet characterization. Actual QFN performance will depend on substrate material, bypass capacitors, resistors, connectors, quality of bias current/voltage source, and assembly process.

| Evaluation Board Bill of Materials |                         |
|------------------------------------|-------------------------|
| Item                               | Description/Part Number |
| Connectors                         | Southwest 214-510SF     |
| Bias Pins                          | Kovar                   |
| Housing                            | Aluminum                |
| Circuit                            | .008 Thick Rogers 4003  |
| 0.1 uF Capacitor                   | AVX 0402YD104KAT2A      |
| 10 Ω Resistor                      | Venkel CR0201-20W-100JT |
| ADM 5929                           | ADM-0026-5929SM         |

DATA SHEET NOTES:

1. Specifications are subject to change without notice. Contact Marki Microwave for the most recent specifications and data sheets.

Marki Microwave reserves the right to make changes to the product(s) or information contained herein without notice. Marki Microwave makes no warranty, representation or guarantee regarding the suitability of its products for any particular purpose, nor does Marki Microwave assume any liability whatsoever arising out of the use of or application of any product.