

### 3 dB QUADRATURE HYBRID

### QH-0R71R3

The QH-0R71R3 is an octave band multi-purpose 3dB quadrature (90°) hybrid. It is designed to mate with the MLIQ connectorized package, for use as an image reject downconverter or single sideband upconverter. Other applications include balanced amplifiers, microwave correlators and microwave Butler matrices. Custom designs are also available; contact the factory for details.

#### Features

- Low insertion loss
- High isolation
- Low VSWR
- [Microwave Power Dividers & Couplers App Note](#)

#### Electrical Specifications

Parameter <sup>1</sup>	Frequency Range (MHz)	Min	Typ	Max
Coupling (dB)	650 to 1300		3	
Phase Shift (Degrees)			90	
Amplitude Balance (dB) <sup>2</sup>			±0.3	±0.7
Phase Balance (Degrees)			±3	±10
Excess Through Line Insertion Loss (dB) <sup>3</sup>			0.5	1.2
VSWR				1.3
Isolation (dB)			13	16
Weight (g)				16

<sup>1</sup>Specifications guaranteed when operated in a 50Ω system.

<sup>2</sup>Maximum amplitude *differential* is twice the magnitude of the amplitude *balance* (see Fig. 3).

<sup>3</sup>Excess Insertion Loss = (Input to Output Insertion Loss) – 3 dB.

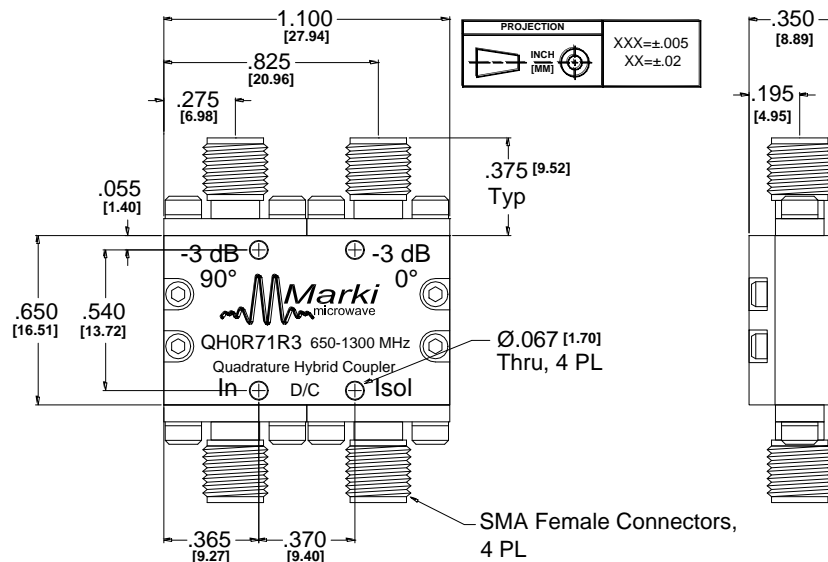

### 3 dB QUADRATURE HYBRID

**QH-0R71R3**

Page 2

#### Application Examples

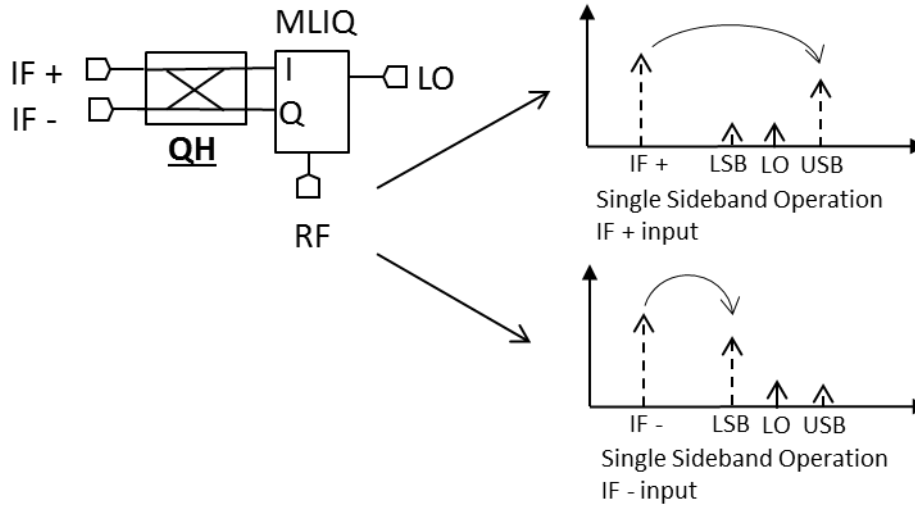

Fig. 1a. Through and coupled line insertion loss.

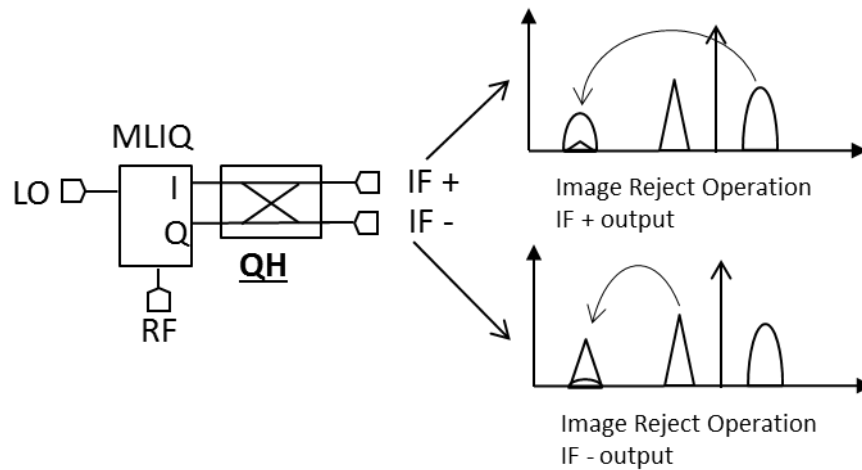

Fig. 1b. Through and coupled line insertion loss.

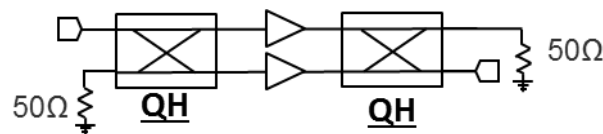

Fig. 1c. Through and coupled line insertion loss.

#### Typical Performance

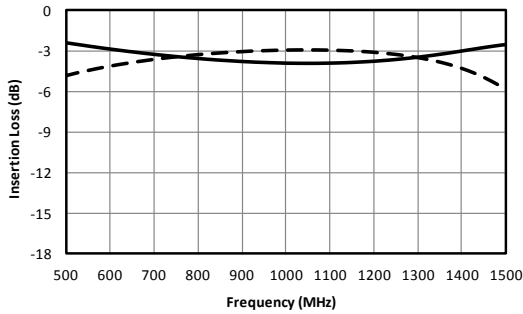

Fig. 2. Through and coupled line insertion loss.

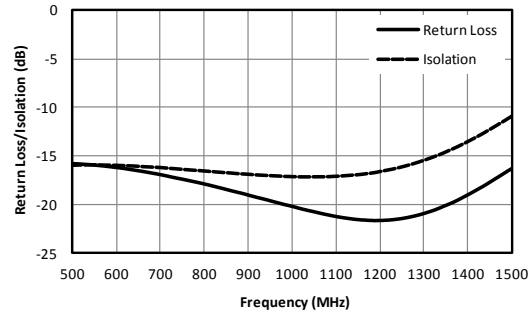

Fig. 3. Typical port return loss and isolation (all ports 50 Ω terminated).

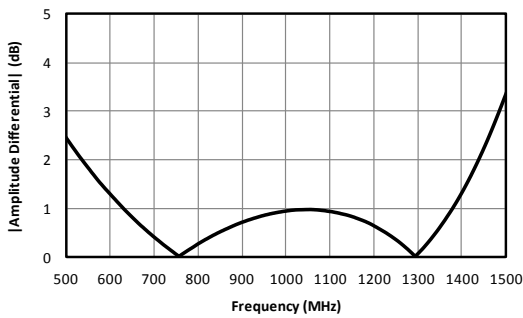

Fig. 4. Amplitude difference between the 0° and 90° output ports.

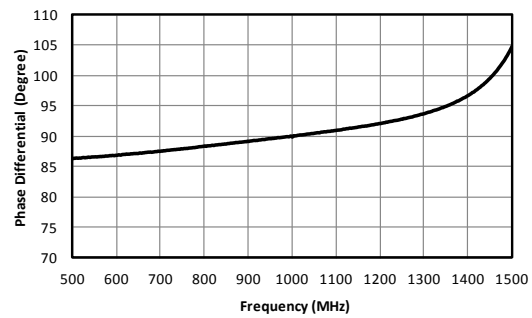

Fig. 5. Phase difference between the 0° and 90° output ports.

Model Number	Description
QH-0R71R3	650-1300 MHz, 3 dB Quadrature Hybrid with SMA connectors <sup>1</sup>

<sup>1</sup>Default is SMA female connectors. Consult factory for other connector options.

Marki Microwave reserves the right to make changes to the product(s) or information contained herein without notice. Marki Microwave makes no warranty, representation or guarantee regarding the suitability of its products for any particular purpose, nor does Marki Microwave assume any liability whatsoever arising out of the use of or application of any product.

© Marki Microwave, Inc.

