

1 Device Overview

1.1 General Description

The MQH-2R58R5 is a MMIC 2.5 GHz – 8.5 GHz quadrature (90°) hybrid. Wire bondable 50Ω terminations are available on-chip. Passive GaAs MMIC technology allows production of smaller constructions that replace larger form factor circuit board constructions. Tight fabrication tolerances allow for less unit to unit variation than traditional quadrature hybrid technologies. The MQH-2R58R5 is available as a wire bondable chip or connectorized module. Low variation allows for accurate simulations using the provided S4P file taken from measured production units. Applications include single sideband upconverters, image rejection downconverters, IQ modulators, balanced amplifiers, microwave correlators, and microwave Butler matrices.



Bare Die



Module

1.2 Features

- Designed for S/C-band applications
- Excellent amplitude and phase balance
- High isolation
- Low insertion loss
- On-chip 50Ω load terminations
- S4P data: [MQH-2R58R5UB.zip](#)

1.3 Functional Block Diagram

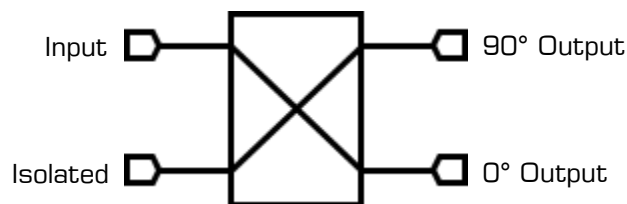

1.4 Part Ordering Options¹

Part Number	Description	Package	Green Status	Product Lifecycle	Export Classification
MQH-2R58R5CH	Wire bondable die	CH	RoHS	Active	EAR99
MQH-2R58R5UB	Connectorized	UB	RoHS	Active	EAR99

¹ Refer to our [website](#) for a list of definitions for terminology presented in this table.

Table of Contents

1	Device Overview	1	3.4	Typical Performance Plots	6
1.1	General Description	1	4	Application Information	7
1.2	Features	1	5	Die Mounting Recommendations	10
1.3	Functional Block Diagram	1	5.1	Mounting and Bonding Recommendations	10
1.4	Part Ordering Options.....	1	5.2	Handling Precautions	10
2	Port Configurations and Functions	3	5.3	Bonding Diagram	11
2.1	Port Diagram	3	5.3.1	Four Port Device	11
2.2	Port Functions	3	5.3.2	Isolated Port Terminated.....	11
3	Specifications	5	6	Mechanical Data.....	12
3.1	Absolute Maximum Ratings.....	5	6.1	CH Package Outline Drawing	12
3.2	Package Information.....	5	6.2	UB Package Outline Drawing.....	12
3.3	Electrical Specifications	5			
3.3.1	Connectorized Package.....	5			

Revision History

Revision Code	Revision Date	Comment
-	August 2018	Datasheet Initial Release

2 Port Configurations and Functions

2.1 Port Diagram

A top-down view of the MQH-2R58R5CH package outline drawing is shown below. This MMIC quadrature hybrid is a passive reciprocal device allowing any port to be used as the input. Ports 1 – 4 correspond to the UB package designation.

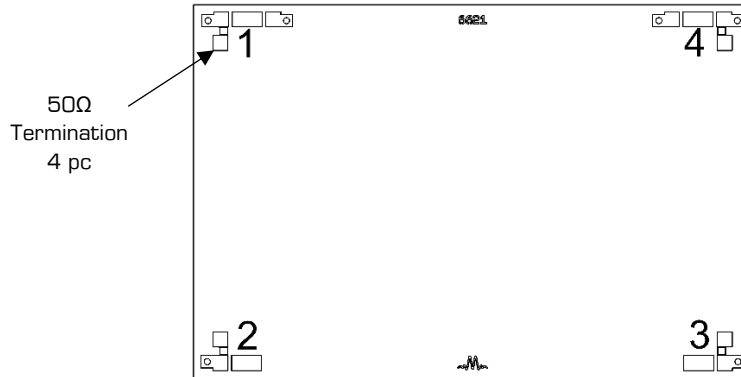

2.2 Port Functions²

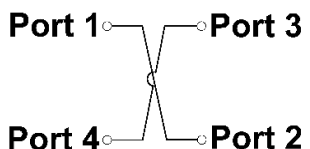
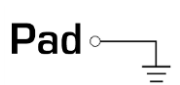
Port	Configuration A	Configuration B	Description	Equivalent Circuit
Port 1	Input	0° Output	Port 1 is DC short to port 2 and open to ground.	
Port 2	0° Output	Input	Port 2 is DC short to port 1 and open to ground.	
Port 3	90° Output	Isolated	Port 3 is DC short to port 4 and open to ground.	
Port 4	Isolated	90° Output	Port 4 is DC short to port 3 and open to ground.	
Pad	Ground	Ground	CH package ground path is provided through the substrate and ground bond pads.	

² Each configuration describes a different application of the same product.

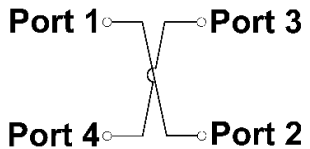
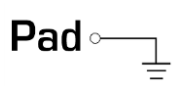
Port	Configuration C	Configuration D	Description	Equivalent Circuit
Port 1	90° Output	Isolated	Port 1 is DC short to port 2 and open to ground.	
Port 2	Isolated	90° Output	Port 2 is DC short to port 1 and open to ground.	
Port 3	Input	0° Output	Port 3 is DC short to port 4 and open to ground.	
Port 4	0° Output	Input	Port 4 is DC short to port 3 and open to ground.	
Pad	Ground	Ground	CH package ground path is provided through the substrate and ground bond pads.	

3 Specifications

3.1 Absolute Maximum Ratings

The Absolute Maximum Ratings indicate limits beyond which damage may occur to the device. If these limits are exceeded, the device may be inoperable or have a reduced lifetime.

Parameter	Maximum Rating	Units
DC Current, at any port	TBD	mA
Power Handling, at any Port	TBD	dBm
Operating Temperature	-55 to +100	°C
Storage Temperature	-65 to +125	°C

3.2 Package Information

Parameter	Details	Rating
ESD	Human Body Model (HBM), per MIL-STD-750, Method 1020	N/A

3.3 Electrical Specifications³

The electrical specifications apply at $T_A=+25^{\circ}\text{C}$ in a 50Ω system.

3.3.1 Connectorized Package

Min and Max limits are guaranteed at $T_A=+25^{\circ}\text{C}$.

Parameter	Frequency (GHz)	Min	Typ.	Max	Units	
Coupling	2.5-8.5		3		dB	
Nominal Phase Shift			90		Degrees	
Amplitude Balance			± 0.4	± 2	dB	
Phase Balance			± 3	± 10	Degrees	
Excess Through Line Insertion Loss				2	4	dB
Isolation			14	23		dB
VSWR				1.15		
Impedance				50		Ω

³ Quadrature hybrid is reciprocal. Reverse measurement is equivalent to forward measurement.

3.4 Typical Performance Plots⁴

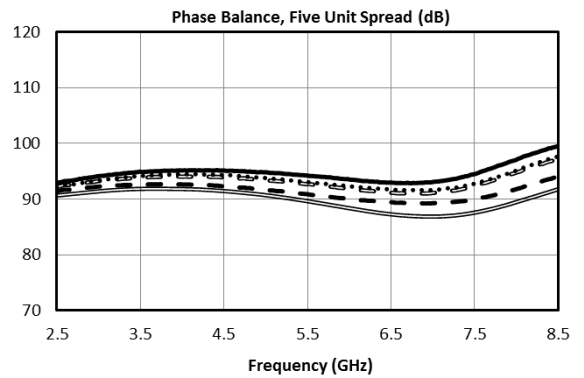
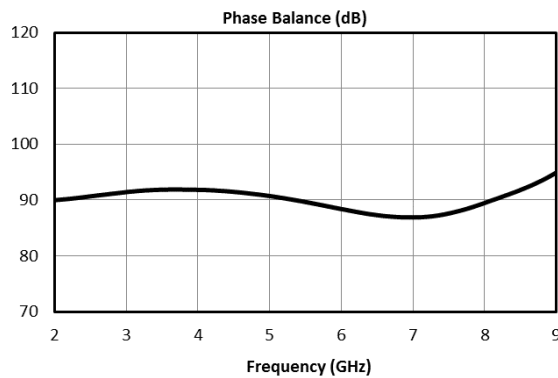
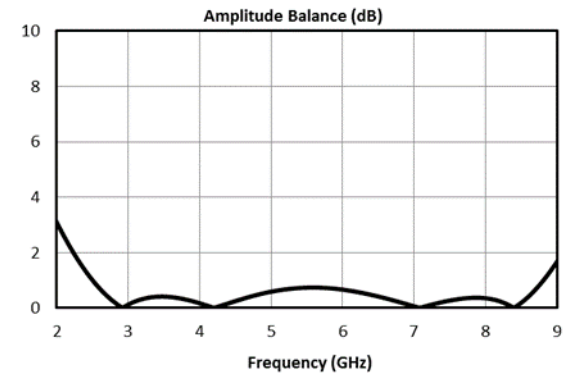
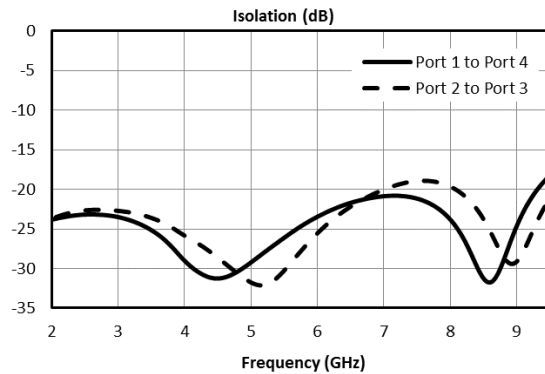
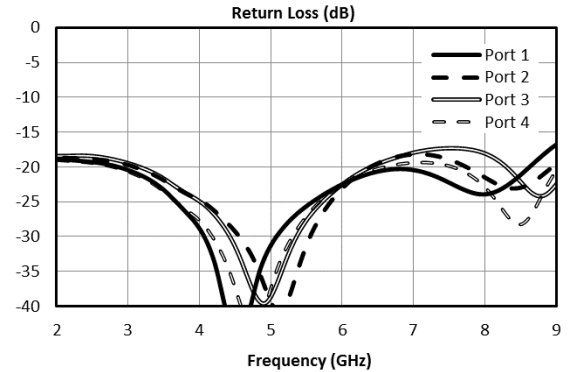
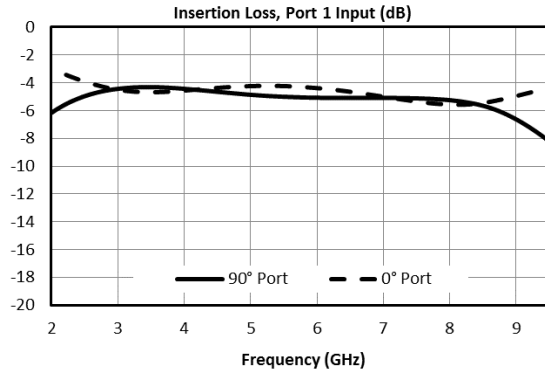

⁴ All measurements taken from a connectorized unit in a 50Ω environment. On-chip load was not used when taking measurements.

4 Application Information

Quadrature signal generation is useful for many applications in analog signal processing. Marki MQH/S MMIC quadrature hybrids and 90° Splitter/Combiners offer this functionality in a small factor with high repeatability. Below are applications and how they can be realized with the MQH and MQS product lines.

Quadrature Hybrids vs 90° Splitter/Combiners

Some products are 'true' quadrature hybrids, while others are 90° Splitter/Combiners. What is the difference? A quadrature hybrid is symmetric about all four ports, meaning that in a splitting application any port can be used as an input, with the isolated and output ports following from this selection. Likewise, for a combining application, any port can be used as an output.

A 90° Splitter/Combiner is not symmetric. When splitting, only ports 1 and 2 can be used as an input. If ports 3 or 4 were used, there would be significant phase walk-off between the output ports. As a combiner, only ports 1 and 2 are suitable as output ports. The phase walk-off introduced when using ports 3 or 4 as an output means that reflected signals recombine and cancel poorly inside a 90° Splitter/Combiner.

Single Sideband and Image Reject Mixers

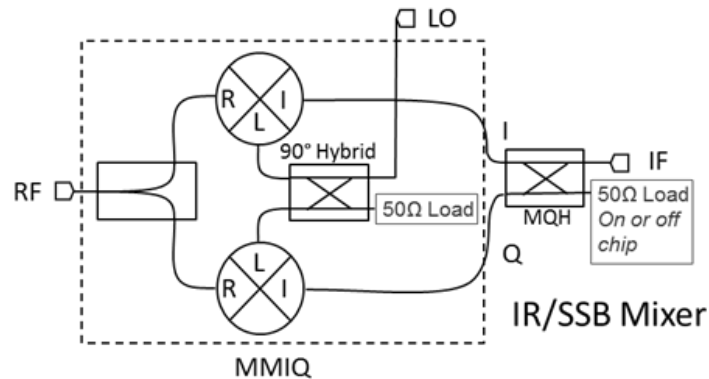

The primary application for the MQH and MQS series is as IF or LO quadrature signal splitter/combiners. They can be used in combination with the MMIQ series of IQ mixers to create broadband single sideband and image reject mixers. Either 90° Splitter/Combiners or quadrature hybrids can be used as the IF hybrid, but if a 90° Splitter/Combiner is used only one sideband (or image) is accessible, whereas if a quadrature hybrid is used then both sidebands are accessible.

If a 90° Splitter/Combiner is used for a single sideband upconverter or image reject mixer, port 1 (or 2) should be used as the IF input/output and ports 2 and 3 (or 1 and 4) should be connected to the I and Q ports. Selecting port 1 or 2 to terminate will select which sideband of the mixer to reject.

Balanced Amplifiers

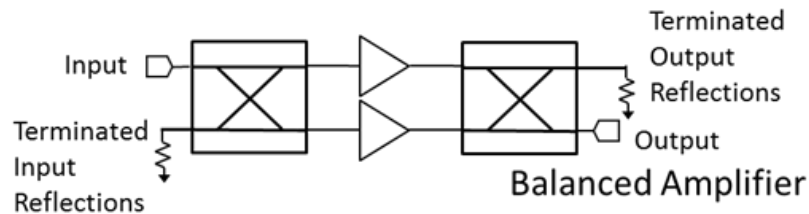

In a balanced amplifier, the poor return loss of an amplifier is compensated for with a quadrature hybrid. In this application, the reflections from the input or output are collected at the isolated port of the quadrature hybrid and terminated.

Since a 90° Splitter/Combiner is not completely symmetric, reflected signals will not terminate as well as with a quadrature hybrid. An MQH option is recommended for this application. If a 90° Splitter/Combiner is used for a single sideband upconverter or image reject mixer, port 1 (or 2) should be used as the IF input/output and ports 2 and 3 (or 1 and 4) should be connected to the I and Q ports. Selecting port 1 or 2 to terminate will select which sideband of the mixer to reject. Testing/simulation is recommended when considering if a 90° Splitter/Combiner is suitable.

Reflectionless Filter

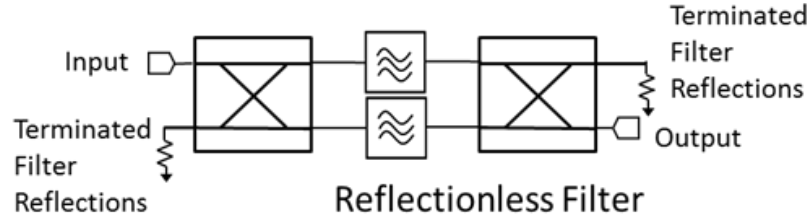

Similar to a balanced amplifier, a reflectionless filter will terminate reflections that are out of band for a filter (but in band for the quadrature hybrid) at the isolated port.

Since a 90° Splitter/Combiner is not completely symmetric, reflected signals will not terminate as well as with a quadrature hybrid. An MQH option is recommended for this application. If a 90° Splitter/Combiner is used for a single sideband upconverter or image reject mixer, port 1 (or 2) should be used as the IF input/output and ports 2 and 3 (or 1 and 4) should be connected to the I and Q ports. Selecting port 1 or 2 to terminate will select which sideband of the mixer to reject. Testing/simulation is recommended when considering if a 90° Splitter/Combiner is suitable.

Reflective Applications

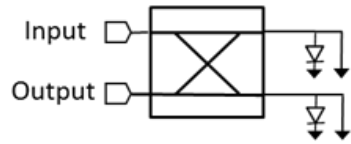

Reflective Phase Shifter

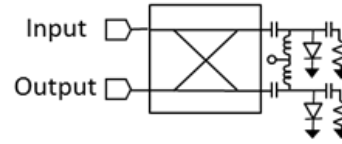

Reflective Attenuator

Unlike in the previous applications, reflective applications only work well with a quadrature hybrid (not a 90° Splitter/Combiner). In these applications a signal is reflected off of two identical structures (typically a PIN diode) and the output signal is collected at the isolated port. In this case the desired signal is deliberately reflected.

Since a 90° Splitter/Combiner is not completely symmetric, you will have poor results if you use one for reflective applications.

5 Die Mounting Recommendations

5.1 Mounting and Bonding Recommendations

Marki MMICs should be attached directly to a ground plane with conductive epoxy. The ground plane electrical impedance should be as low as practically possible. This will prevent resonances and permit the best possible electrical performance. Datasheet performance is only guaranteed in an environment with a low electrical impedance ground.

Mounting - To epoxy the chip, apply a minimum amount of conductive epoxy to the mounting surface so that a thin epoxy fillet is observed around the perimeter of the chip. Cure epoxy according to manufacturer instructions.

Wire Bonding - Ball or wedge bond with 0.025 mm (1 mil) diameter pure gold wire. Thermosonic wirebonding with a nominal stage temperature of 150 °C and a ball bonding force of 40 to 50 grams or wedge bonding force of 18 to 22 grams is recommended. Use the minimum level of ultrasonic energy to achieve reliable wirebonds. Wirebonds should be started on the chip and terminated on the package or substrate.

Circuit Considerations – 50 Ω transmission lines should be used for all high frequency connections in and out of the chip. In circumstances where the chip more than .001” thinner than the substrate, a heat spreading spacer tab is optional to further reduce bondwire length and parasitic inductance.

Special Considerations for 90° Splitters – Transitions between the chip and transmission line should be as close to 50 Ω as possible. Small impedance mismatches will result in poor phase balance mid-band due to reflections. Length and number of wire bonds should be adjusted to tune inductance for an optimal 50 Ω match. In the modules, chip transitions are optimized for broadband performance.

5.2 Handling Precautions

General Handling

Chips should be handled with care using tweezers or a vacuum collet. Users should take precautions to protect chips from direct human contact that can deposit contaminants, like perspiration and skin oils on any of the chip's surfaces.

Cleaning and Storage: Do not attempt to clean the chip with a liquid cleaning system or expose the bare chips to liquid. Once the ESD sensitive bags the chips are stored in are opened, chips should be stored in a dry nitrogen atmosphere.

5.3 Bonding Diagram

The MQH-2R58R5 has 50Ω loads near each I/O port, allowing the user to terminate the isolated port on-chip.

5.3.1 Four Port Device

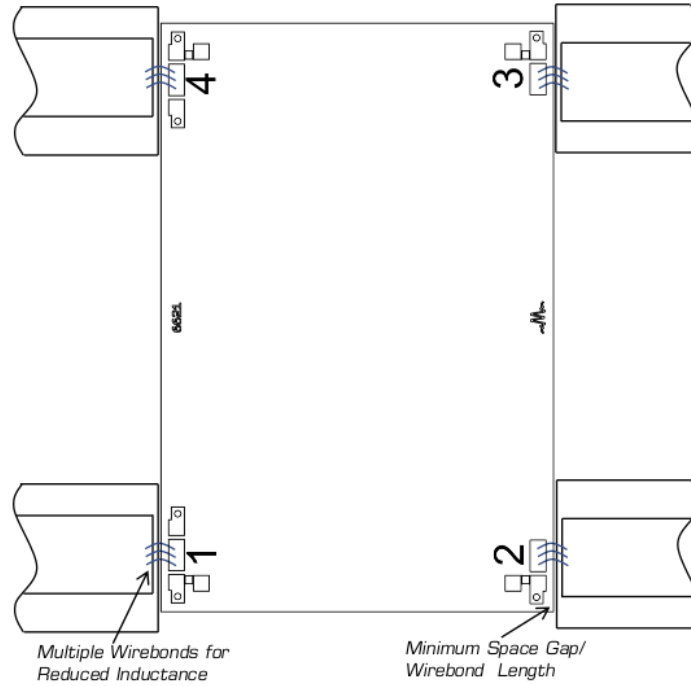

5.3.2 Isolated Port Terminated

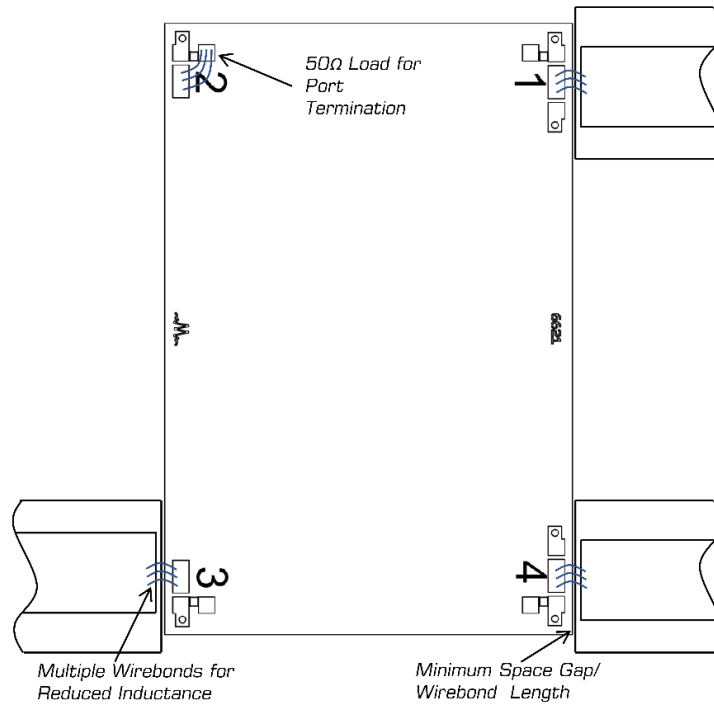

6 Mechanical Data

6.1 CH Outline Drawing

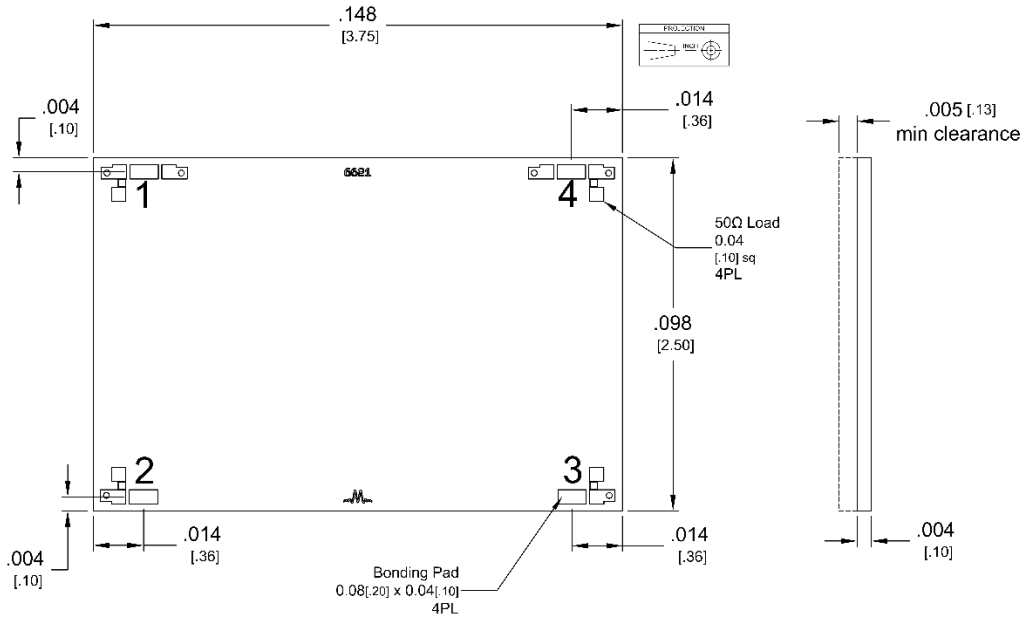

1. CH Substrate material is 0.004 in thick GaAs.
2. I/O trace finish is 5 microns Au. Ground plane finish is 4 microns Au.

6.2 UB Package Outline Drawing

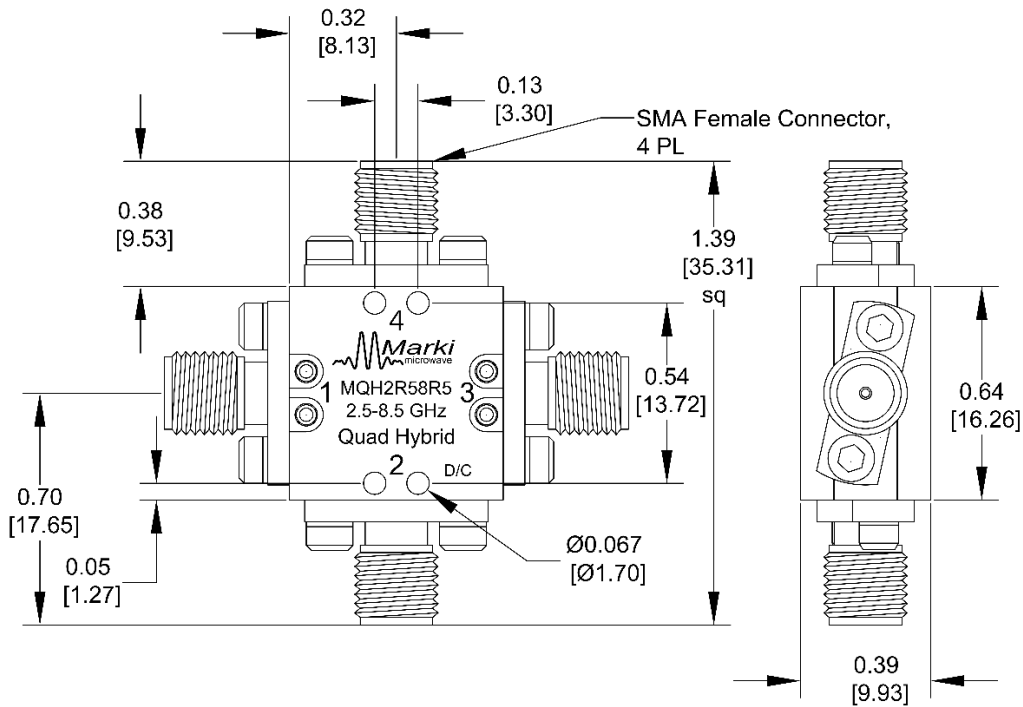

Marki Microwave reserves the right to make changes to the product(s) or information contained herein without notice.
 Marki Microwave makes no warranty, representation, or guarantee regarding the suitability of its products for any particular purpose, nor does Marki Microwave assume any liability whatsoever arising out of the use or application of any product.