

## Passive GaAs MMIC IQ Mixer

## MMIQ-0626HSM

### 1. Device Overview

#### 1.1 General Description

MMIQ-0626HSM is a high linearity, passive GaAs MMIC IQ mixer. This is an ultra-broadband mixer spanning 6 to 26 GHz on the RF and LO ports with an IF from DC to 6 GHz. Up to 40 dB of image rejection is available due to the excellent phase and amplitude balance of its on-chip LO quadrature hybrid. Both surface QFNs and evaluation boards are available. For a list of recommended LO driver amps for all mixers and IQ mixers, see [here](#).

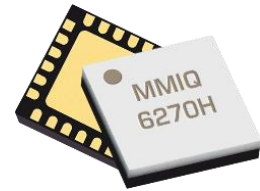

QFN

#### 1.2 Electrical Summary

Parameter	Typical	Unit
RF/LO Frequency Range	6 - 26	GHz
IF Frequency Range	DC - 6	GHz
I+Q Conversion Loss	9	dB
Image Rejection	35	dB
LO-RF Isolation	36	dB

#### 1.3 Applications

- Single Side Band & Image Rejection Mixing
- IQ Modulation/Demodulation
- Vector Amplitude Modulation
- Band Shifting

#### 1.4 Functional Block Diagram

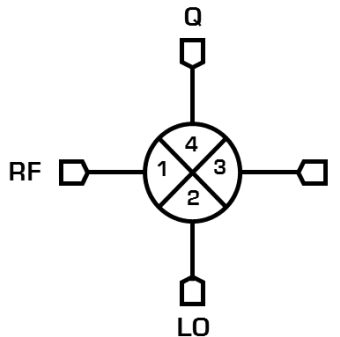

#### 1.5 Part Ordering Options<sup>1</sup>

Part Number	Description	Package	Green Status	Product Lifecycle	Export Classification
MMIQ-0626HSM-2	4x4 mm QFN	SM	RoHS	Active	EAR99
EVAL-MMIQ-0626H	Connectorized module, QFN reflowed onto PCB	EVAL	Non-RoHS	Active	EAR99

<sup>1</sup> Refer to our [website](#) for a list of definitions for terminology presented in this table.

## Table of Contents

1. Device Overview .....	1	3.2 Package Information .....	4
1.1 General Description.....	1	3.3 Recommended Operating Conditions .	4
1.2 Electrical Summary.....	1	3.4 Sequencing Requirements .....	4
1.3 Applications .....	1	3.5 Electrical Specifications .....	5
1.4 Functional Block Diagram .....	1	3.6 Typical Performance Plots .....	6
1.5 Part Ordering Options.....	1	4. Mechanical Data.....	12
2. Port Configurations and Functions .....	3	4.1 SM Package outline drawing .....	12
2.1 Port Diagram .....	3	4.2 SM Package Footprint .....	12
2.2 Port Functions .....	3	4.3 Evaluation Board Outline Drawing...	13
3. Specifications .....	4		
3.1 Absolute Maximum Ratings.....	4		

## Revision History

Revision Code	Revision Date	Comment
-	August 2018	Datasheet Initial Release
A	August 2019	Changed I/Q Max Current Rating
B	October 2019	Updated Max Power Rating



## 2. Port Configurations and Functions

### 2.1 Port Diagram

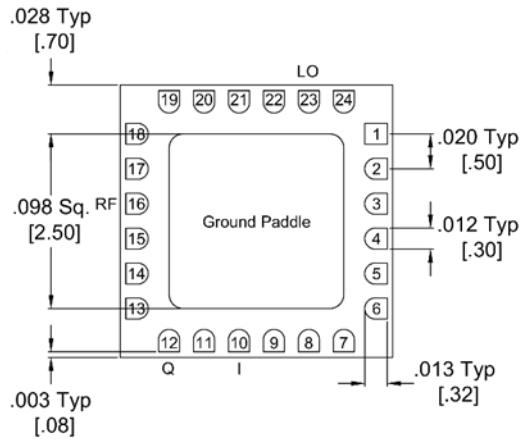
A bottom-up view of the MMIQ-0626H's SM package outline drawing is shown below. The mixer may be operated as either a downconverter or an upconverter. Use of the RF or IF as the input or output port will depend on the application.

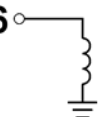

### 2.2 Port Functions

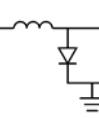
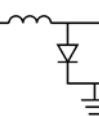
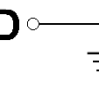
Port	Function	Description	Equivalent Circuit
Pin 16	RF Input/Output	Pin 16 is DC short and AC matched to 50Ω over the specified RF frequency range.	<b>P16</b> 
Pin 23	LO Input	Pin 23 is DC open and AC matched to 50Ω over the specified LO frequency range.	<b>P23</b> 
Pin 10	I Input / Output	Pin 10 is diode coupled and AC matched to 50Ω over the specified I port frequency range.	<b>P10</b> 
Pin 12	Q Input / Output	Pin 12 is diode coupled and AC matched to 50Ω over the specified Q port frequency range.	<b>P12</b> 
GND	Ground	SM package ground path is provided through the ground paddle.	<b>GND</b> 

### 3. Specifications

#### 3.1 Absolute Maximum Ratings

The Absolute Maximum Ratings indicate limits beyond which damage may occur to the device. If these limits are exceeded, the device may be inoperable or have a reduced lifetime.

Parameter	Maximum Rating	Units
Pin 10 DC Current	30	mA
Pin 12 DC Current	30	mA
Power Handling, at any Port	+26	dBm
Operating Temperature	-55 to +100	°C
Storage Temperature	-65 to +125	°C

#### 3.2 Package Information

Parameter	Details	Rating
ESD	Human Body Model (HBM), per MIL-STD-750, Method 1020	1A
Weight	EVAL Package	13.4 g

#### 3.3 Recommended Operating Conditions

The Recommended Operating Conditions indicate the limits, inside which the device should be operated, to guarantee the performance given in Electrical Specifications. Operating outside these limits may not necessarily cause damage to the device, but the performance may degrade outside the limits of the electrical specifications. For limits, above which damage may occur, see Absolute Maximum Ratings.

	Min	Nominal	Max	Units
T <sub>A</sub> , Ambient Temperature	-55	+25	+100	°C
LO drive power	+13	+19	+23	dBm
RF/IF input power			+11	dBm

#### 3.4 Sequencing Requirements

There is no requirement to apply power to the ports in a specific order. However, it is recommended to provide a 50Ω termination to each port before applying power. This is a passive diode mixer that requires no DC bias.

### 3.5 Electrical Specifications

The electrical specifications apply at  $T_A=+25^{\circ}\text{C}$  in a  $50\Omega$  system. Typical data shown is for a down conversion application with a  $+19\text{dBm}$  sine wave LO input.

Min and Max limits apply only to our connectorized units and are guaranteed at  $T_A=+25^{\circ}\text{C}$ . All bare die are 100% DC tested and visually inspected.

Parameter	Test Conditions	Min	Typical	Max	Units
RF (Port 1) Frequency Range		6		26	GHz
LO (Port 2) Frequency Range		6		26	
I (Port 3) Frequency Range		0		6	
Q (Port 4) Frequency Range		0		6	
Conversion Loss (CL) <sup>2</sup>	RF/LO = 6 - 24 GHz I = DC - 0.2 GHz		12	14	dB
	RF/LO = 24 - 26 GHz I = DC - 0.2 GHz		14	17	
	RF/LO = 6 - 26 GHz I = 0.2 - 6 GHz		13		
	RF/LO = 6 - 24 GHz Q = DC - 0.2 GHz		12	16	
	RF/LO = 24 - 26 GHz Q = DC - 0.2 GHz		12	14	
	RF/LO = 6 - 26 GHz Q = 0.2 - 6 GHz		12		
Noise Figure (NF) <sup>3</sup>	RF/LO = 6 - 24 GHz I = DC - 0.2 GHz		12		dB
	RF/LO = 6 - 24 GHz Q = DC - 0.2 GHz		12		
Image Rejection (IR) <sup>4</sup>	RF/LO = 6 - 26 GHz I+Q = DC - 0.2 GHz		35		dBc
Amplitude Balance <sup>5</sup>			0.5		dB
Phase Balance			3		°
Isolation	LO to RF	RF/LO = 6 - 26 GHz		36	dB
	LO to IF	IF/LO = 6 - 26 GHz		43	
	RF to IF	RF/IF = 6 - 26 GHz		34	
Input IP3 (IIP3) <sup>6</sup>	I+Q	RF/LO = 6 - 26 GHz I = DC - 0.2 GHz		25	dBm
Input 1 dB Gain Compression Point (P1dB)	I			11	dBm
	Q			11	

<sup>2</sup> Measured as an I/Q down converter. (i.e., I and Q powers are not combined)

<sup>3</sup> Mixer Noise Figure typically measures within 0.5 dB of conversion loss for IF frequencies greater than 5 MHz.

<sup>4</sup> Image Rejection and Single sideband performance plots are defined by the upper sideband (USB) or lower sideband (LSB) with respect to the LO signal. Plots are defined by which sideband is selected by the external IF quadrature hybrid.

<sup>5</sup> Amplitude and phase balance measured in a down conversion.

<sup>6</sup> Typical IIP3 measured with I and Q ports combined with an external quadrature hybrid coupler in a down conversion.

### 3.6 Typical Performance Plots<sup>7</sup>

Parameter		Pin	Start	Nominal	Stop	Units
RF Input Frequency		16	0		26	GHz
RF Input Power				-10		dBm
LO Input Frequency		23	0.091		26.091	GHz
LO Input Power				+19		dBm
IF Output Frequency	I	10		91		MHz
	Q	12		91		
	I+Q <sup>8</sup>	3+4		91		
T <sub>A</sub> , Ambient Temperature				+25		°C
Z <sub>0</sub> , System Impedance				50		Ω

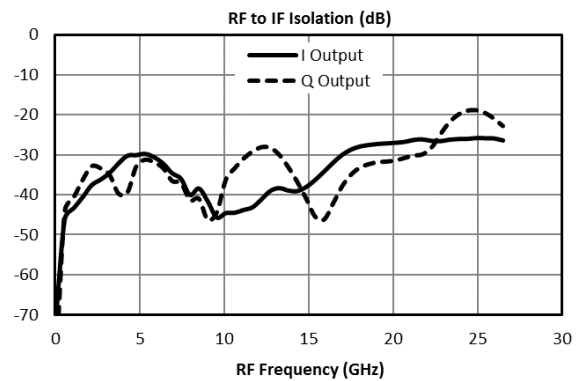
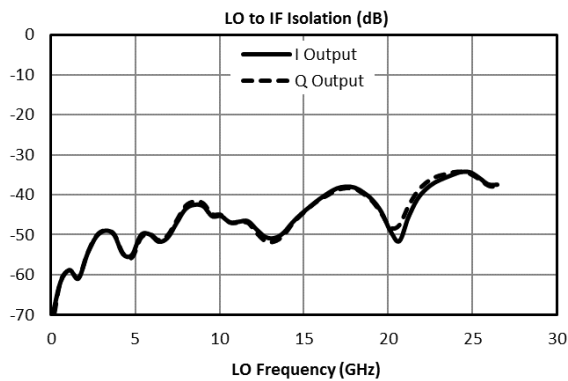
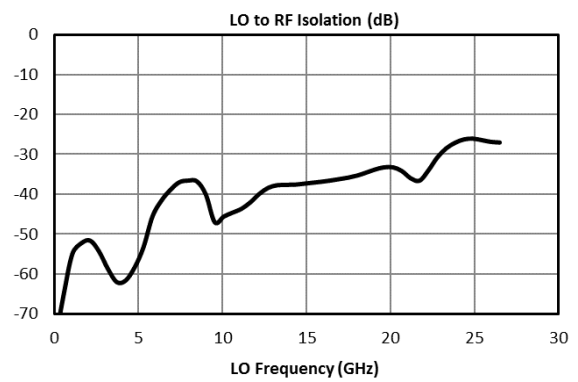
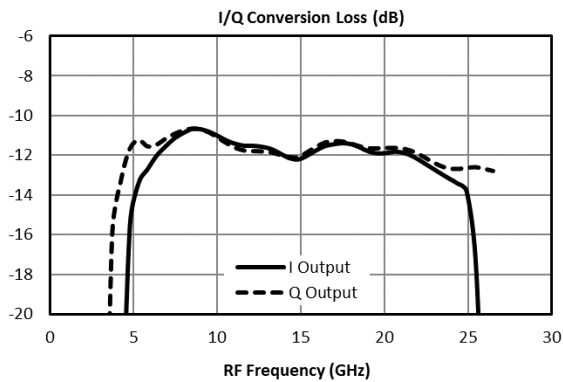

<sup>7</sup> I output means that the IF output signal is measured at the I port of the mixer and the Q port is loaded. Q output means the IF output signal is measured at the Q port of the mixer while the I port is loaded.

<sup>8</sup> I+Q measurements taken with an external quadrature hybrid attached to the I and Q ports of the mixer. Orientation depends on up conversion or down conversion measurement.

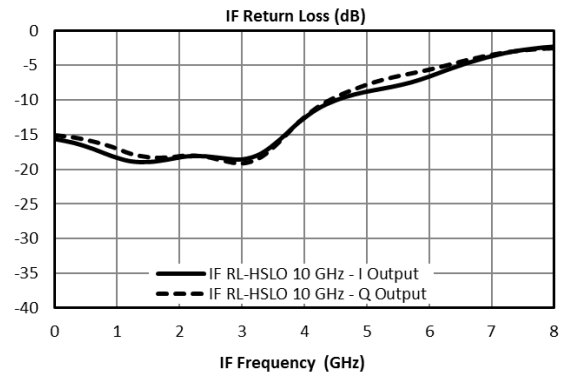
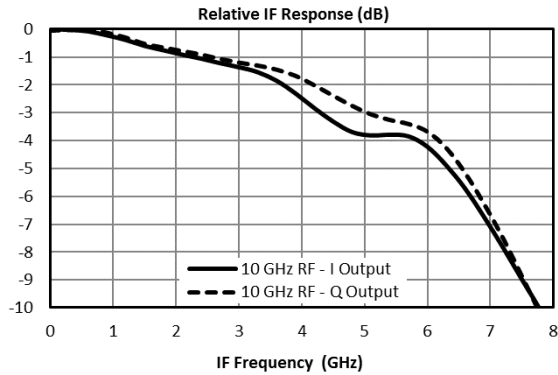
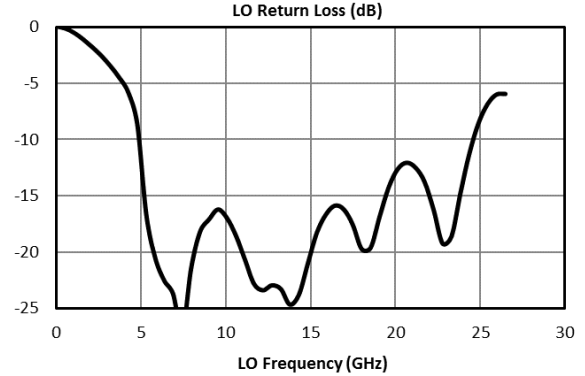
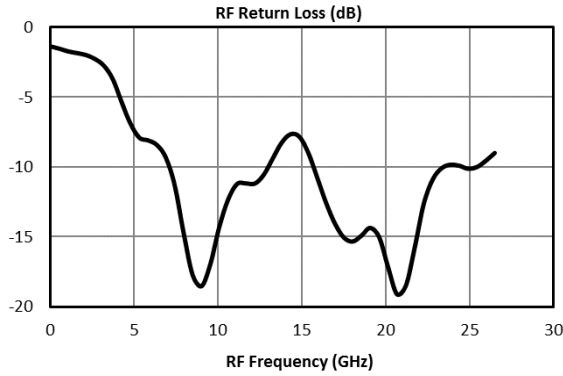

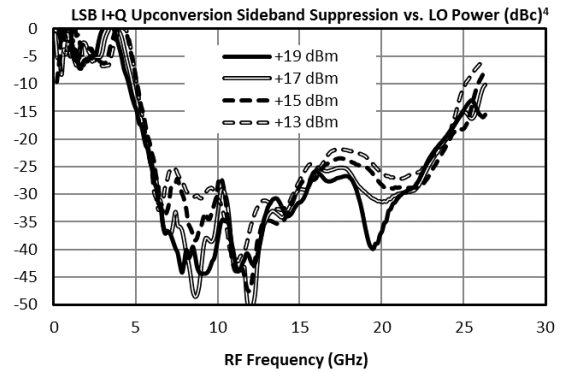
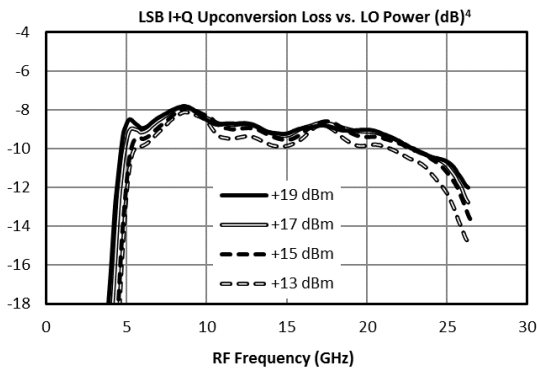
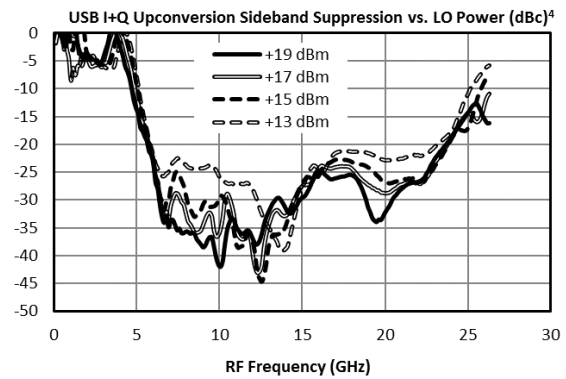
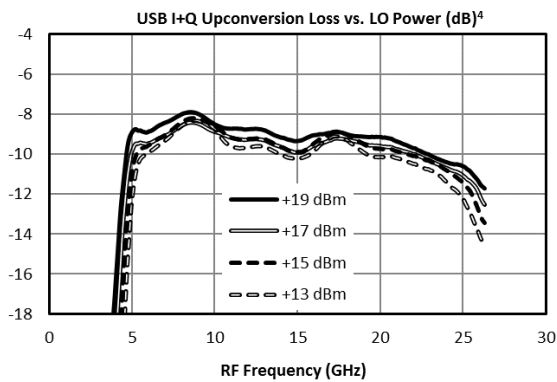
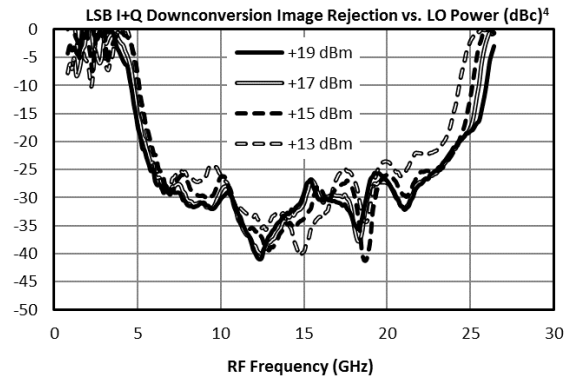
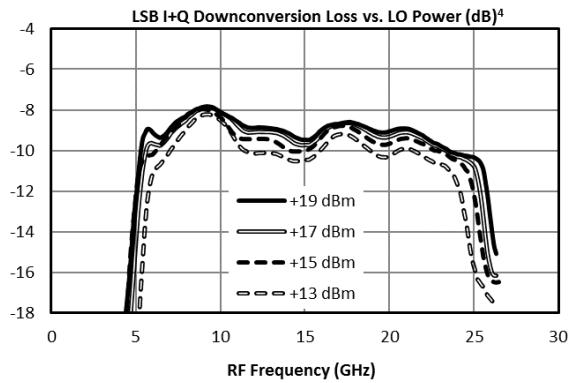
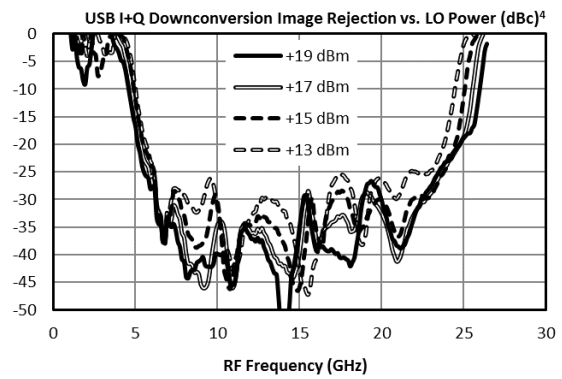
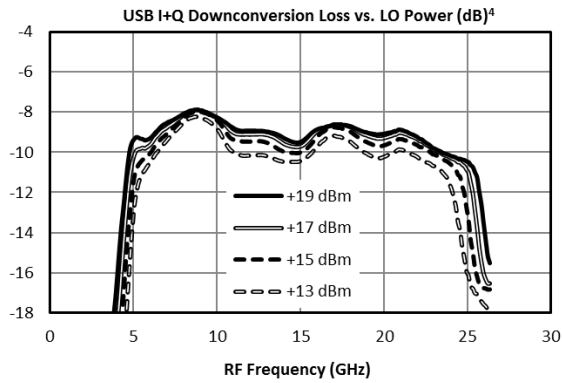



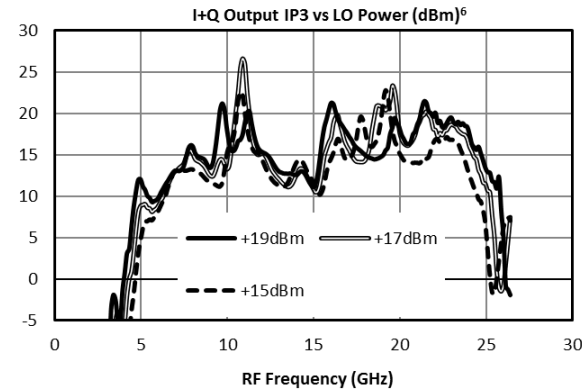
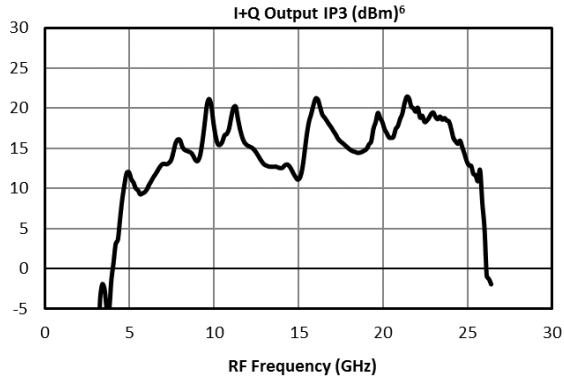
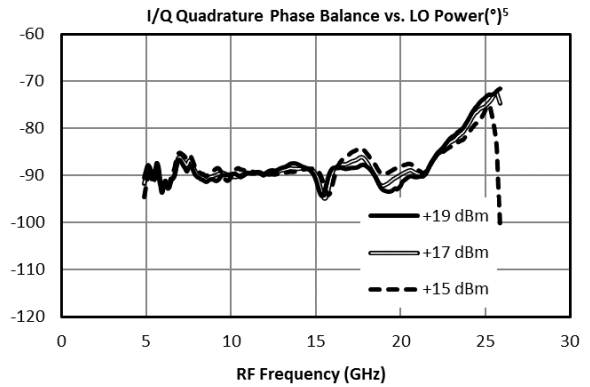
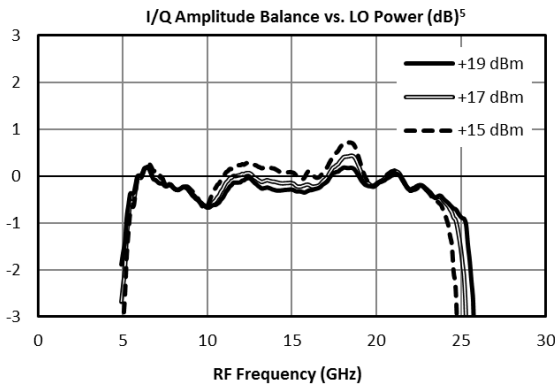
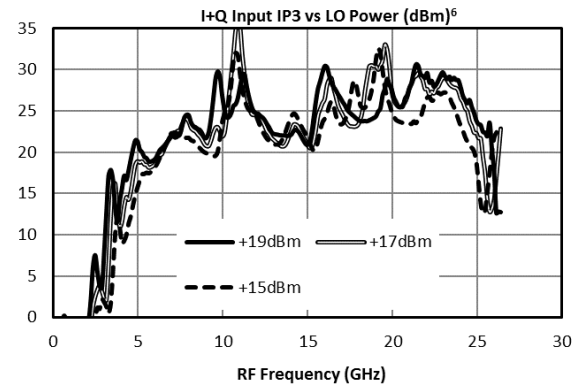
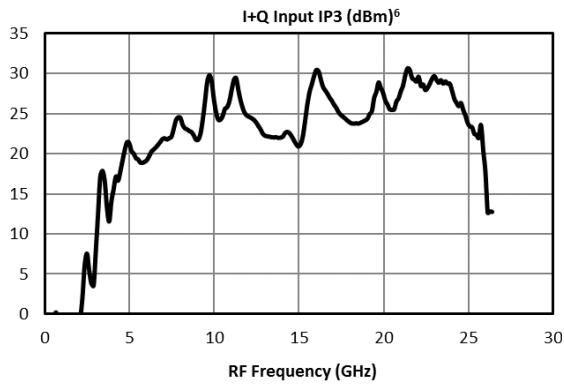

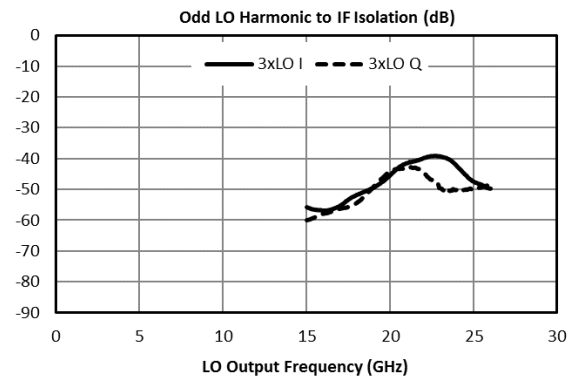
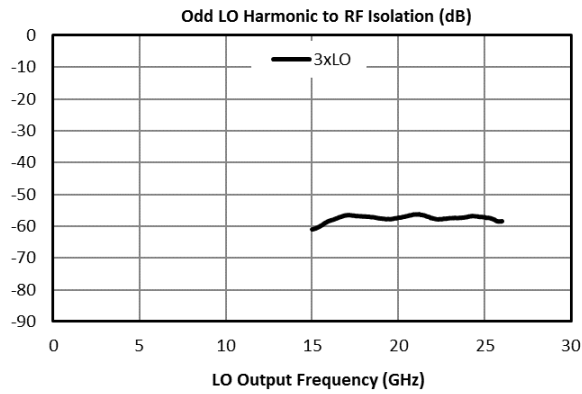
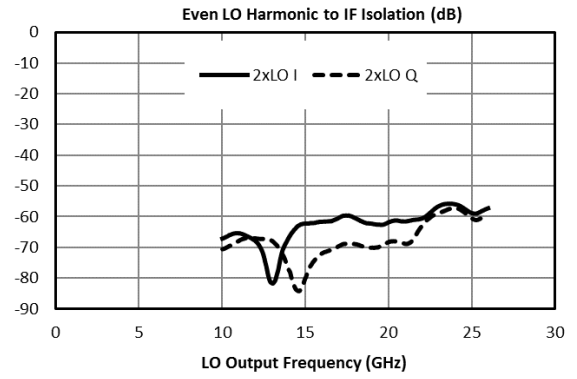
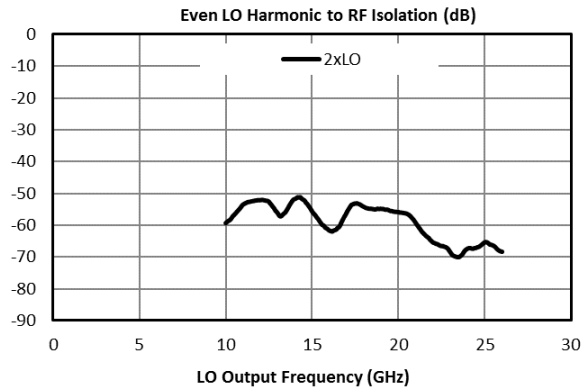

### 3.6.1 Typical Spurious Performance: Down-Conversion

Typical spurious data is provided by selecting RF and LO frequencies ( $\pm m \cdot \text{LO} \pm n \cdot \text{RF}$ ) within the RF/LO bands, to create a spurious output within the IF band. The mixer is swept across the full spurious band and the mean is calculated. The numbers shown in the table below are for a -10 dBm RF input. Spurious suppression is scaled for different RF power levels by  $(n-1)$ , where "n" is the RF spur order. For example, the 2RF x 2LO spur is 80 dBc for a -10 dBm input, so a -20 dBm RF input creates a spur that is  $(2-1) \times (-10 \text{ dB})$  lower, or 90 dBc isolation.

**Typical Down-conversion spurious suppression (dBc): I Port (Q Port)**

-10 dBm RF Input	0xLO	1xLO	2xLO	3xLO	4xLO	5xLO
0xRF	-	49 (50)	60 (60)	57 (56)	74 (75)	N/A
1xRF	33 (39)	Reference	47 (36)	60 (52)	51 (60)	N/A
2xRF	73 (77)	54 (56)	80 (74)	63 (64)	79 (77)	78 (70)
3xRF	96 (95)	69 (69)	83 (86)	79 (81)	99 (99)	72 (74)
4xRF	131 (131)	103 (109)	119 (120)	100 (110)	122 (121)	115 (115)
5xRF	N/A	N/A	135 (137)	131 (131)	126 (134)	131 (133)

### 3.6.6 Typical Spurious Performance: Up-Conversion

Typical spurious data is taken by mixing an input within the IF band, with LO frequencies ( $\pm m \cdot \text{LO} \pm n \cdot \text{IF}$ ), to create a spurious output within the RF output band. The mixer is swept across the full spurious output band and the mean is calculated. The numbers shown in the table below are for a -10 dBm IF input. Spurious suppression is scaled for different IF input power levels by  $(n-1)$ , where "n" is the IF spur order. For example, the 2IFx1LO spur is typically 41 dBc for a -10 dBm input with a sine-wave LO, so a -20 dBm IF input creates a spur that is  $(2-1) \times (-10 \text{ dB})$  lower, or 51 dBc.

-10 dBm IF Input	0xLO	1xLO	2xLO	3xLO	4xLO	5xLO
0xIF	-	39 (44)	59 (59)	67 (67)	66 (66)	N/A
1xIF	33 (39)	Reference	36 (33)	22 (26)	58 (49)	N/A
2xIF	54 (55)	41 (41)	65 (66)	64 (56)	100 (101)	89 (75)
3xIF	88 (85)	54 (55)	83 (84)	66 (59)	101 (91)	90 (84)
4xIF	112 (113)	84 (84)	103 (107)	95 (89)	110 (106)	121 (104)
5xIF	131 (132)	108 (109)	128 (129)	104 (103)	126 (127)	125 (110)

## 4. Mechanical Data

### 4.1 SM Package outline drawing

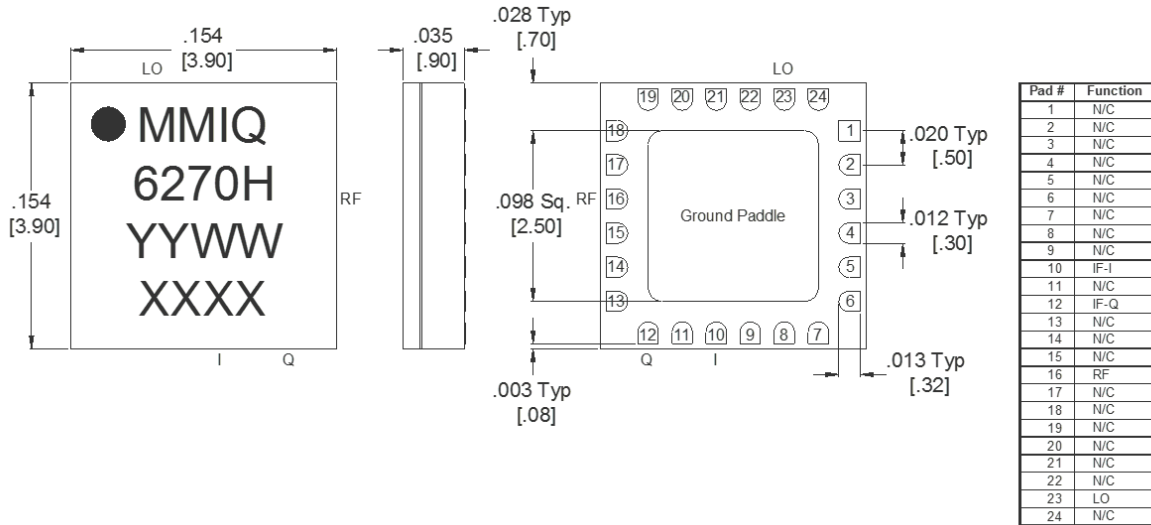

- Substrate material is ceramic.
- I/O Leads and Ground Paddle plating is (from base to finish):
 

Ni:	8.89um MAX	1.27um MIN
Pd:	0.17um MAX	0.07um MIN
Au	0.254um MAX	0.03um MIN
- All unconnected pads should be connected to PCB RF ground.

### 4.2 SM Package Footprint

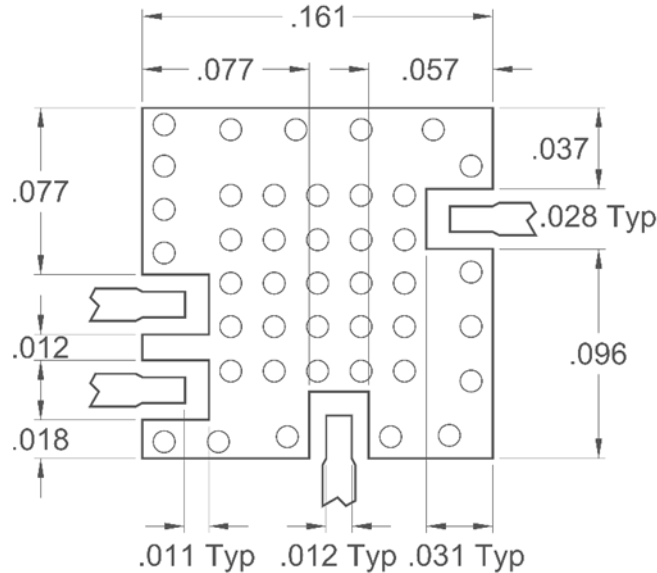

QFN-Package Surface-Mount Landing Pattern

[Click here for a DXF of the above layout.](#)

[Click here for leaded solder reflow.](#) [Click here for lead-free solder reflow](#)

### 4.3 Evaluation Board Outline Drawing

Port	Connector Type
LO	SMA Female
RF	SMA Female
I/Q	SMA Female

Note: Eval Connectors are not removeable.

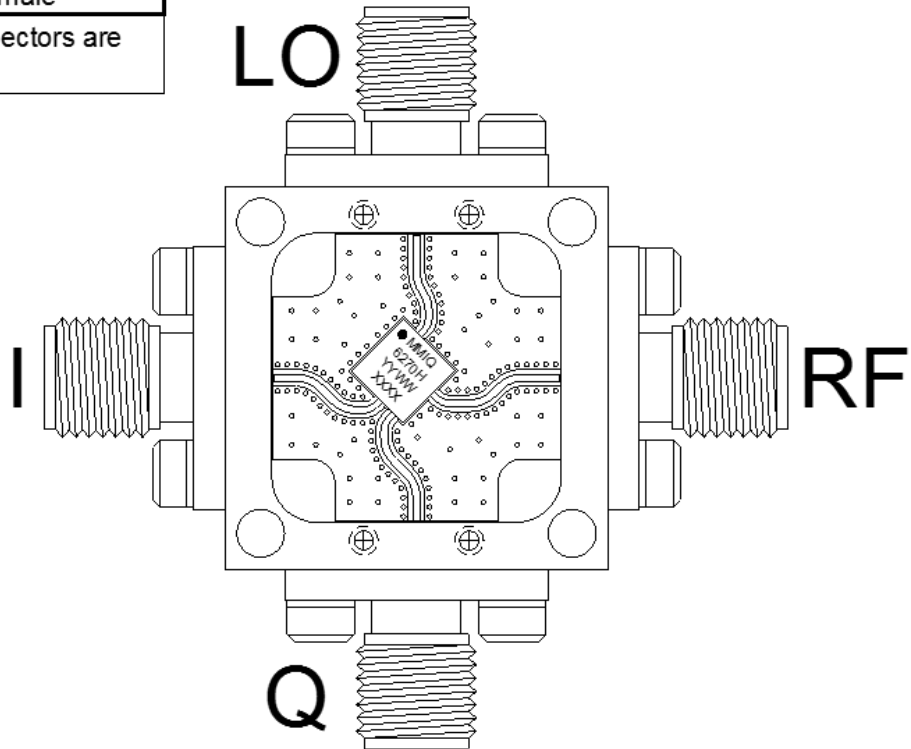

Marki Microwave reserves the right to make changes to the product(s) or information contained herein without notice.

Marki Microwave makes no warranty, representation, or guarantee regarding the suitability of its products for any particular purpose, nor does Marki Microwave assume any liability whatsoever arising out of the use or application of any product.