

Passive GaAs MMIC IQ Mixer

MMIQ-0520HSM

1. Device Overview

General Description

MMIQ-0520HSM is a high linearity, passive GaAs MMIC IQ mixer. This is an ultra-broadband mixer spanning 5 to 20GHz on the RF and LO ports with an IF from DC to 6 GHz. Up to 40 dB of image rejection is available due to the excellent phase and amplitude balance of its on-chip LO quadrature hybrid. The MMIQ 0520HSM is available in a 4x4 mm QFN package. Evaluation boards are available.

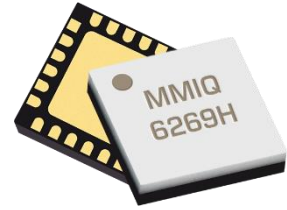

QFN

1.2 Electrical Summary

| Parameter | Typical | Unit |
|-----------------------|---------|------|
| RF/LO Frequency Range | 5 - 20 | GHz |
| IF Frequency Range | DC - 6 | GHz |
| I+Q Conversion Loss | 9 | dB |
| Image Rejection | 35 | dB |
| LO-RF Isolation | 39 | dB |

1.3 Applications

- Single Side Band & Image Rejection Mixing
- IQ Modulation/Demodulation
- Vector Amplitude Modulation
- Band Shifting

1.4 Functional Block Diagram

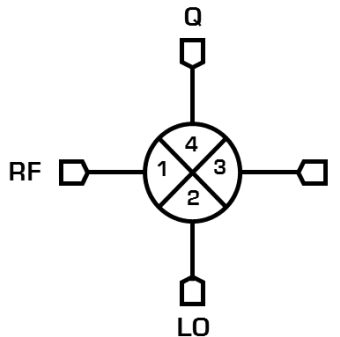

1.5 Part Ordering Options¹

| Part Number | Description | Package | Green Status | Product Lifecycle | Export Classification |
|-----------------|---|---------|--------------|-------------------|-----------------------|
| MMIQ-0520HSM-2 | 4x4 mm QFN | SM | RoHS | Active | EAR99 |
| EVAL-MMIQ-0520H | Connectorized module, QFN reflowed onto PCB | EVAL | Non-RoHS | Active | EAR99 |

¹ Refer to our [website](#) for a list of definitions for terminology presented in this table.

Table of Contents

| | | | |
|--|---|--|----|
| 1. Device Overview | 1 | 3.2 Package Information | 4 |
| General Description | 1 | 3.3 Recommended Operating Conditions . | 4 |
| 1.2 Electrical Summary..... | 1 | 3.4 Sequencing Requirements | 4 |
| 1.3 Applications | 1 | 3.5 Electrical Specifications | 5 |
| 1.4 Functional Block Diagram | 1 | 3.6 Typical Performance Plots | 6 |
| 1.5 Part Ordering Options..... | 1 | 4. Mechanical Data..... | 12 |
| 2. Port Configurations and Functions | 3 | 4.1 SM Package Outline Drawing | 12 |
| 2.1 Port Diagram | 3 | 4.2 SM Package Footprint | 12 |
| 2.2 Port Functions | 3 | 4.3 Evaluation Board Outline Drawing.... | 13 |
| 3. Specifications | 4 | | |
| 3.1 Absolute Maximum Ratings..... | 4 | | |

Revision History

| Revision Code | Revision Date | Comment |
|---------------|---------------|---------------------------|
| - | August 2018 | Datasheet Initial Release |

2. Port Configurations and Functions

2.1 Port Diagram

A bottom-up view of the MMIQ-0520H's SM package outline drawing is shown below. The mixer may be operated as either a downconverter or an upconverter. Use of the RF or IF as the input or output port will depend on the application.

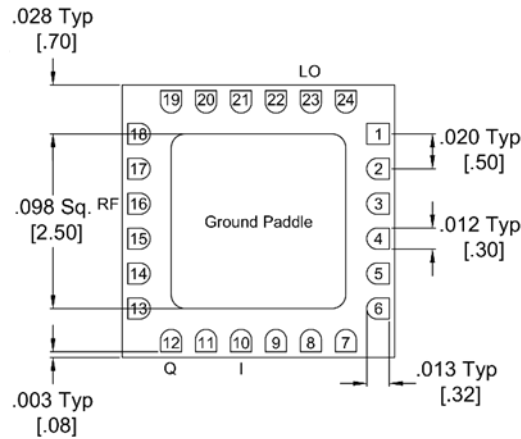

2.2 Port Functions

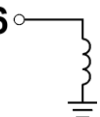
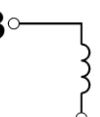
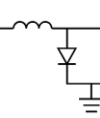
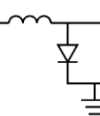
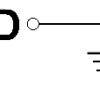
| Port | Function | Description | Equivalent Circuit |
|--------|------------------|--|--|
| Pin 16 | RF Input/Output | Pin 16 is DC short and AC matched to 50Ω over the specified RF frequency range. | P16  |
| Pin 23 | LO Input | Pin 23 is DC open and AC matched to 50Ω over the specified LO frequency range. | P23  |
| Pin 10 | I Input / Output | Pin 10 is diode coupled and AC matched to 50Ω over the specified I port frequency range. | P10  |
| Pin 12 | Q Input / Output | Pin 12 is diode coupled and AC matched to 50Ω over the specified Q port frequency range. | P12  |
| GND | Ground | SM package ground path is provided through the ground paddle. | GND  |

3. Specifications

3.1 Absolute Maximum Ratings

The Absolute Maximum Ratings indicate limits beyond which damage may occur to the device. If these limits are exceeded, the device may be inoperable or have a reduced lifetime.

| Parameter | Maximum Rating | Units |
|-----------------------------|----------------|-------|
| Pin 10 DC Current | 50 | mA |
| Pin 12 DC Current | 50 | mA |
| Power Handling, at any Port | +23 | dBm |
| Operating Temperature | -55 to +100 | °C |
| Storage Temperature | -65 to +125 | °C |

3.2 Package Information

| Parameter | Details | Rating |
|-----------|--|--------|
| ESD | Human Body Model (HBM), per MIL-STD-750, Method 1020 | 1 A |
| Weight | EVAL package | 13.4 g |

3.3 Recommended Operating Conditions

The Recommended Operating Conditions indicate the limits, inside which the device should be operated, to guarantee the performance given in Electrical Specifications. Operating outside these limits may not necessarily cause damage to the device, but the performance may degrade outside the limits of the electrical specifications. For limits, above which damage may occur, see Absolute Maximum Ratings.

| | Min | Nominal | Max | Units |
|--------------------------------------|-----|---------|------|-------|
| T _A , Ambient Temperature | -55 | +25 | +100 | °C |
| LO drive power | +13 | +19 | +23 | dBm |
| RF/IF input power | | | +11 | dBm |

3.4 Sequencing Requirements

There is no requirement to apply power to the ports in a specific order. However, it is recommended to provide a 50Ω termination to each port before applying power. This is a passive diode mixer that requires no DC bias.

3.5 Electrical Specifications

The electrical specifications apply at $T_A=+25^{\circ}\text{C}$ in a 50Ω system. Typical data shown is for a down conversion application with a +19dBm sine wave LO input.

| Parameter | | Test Conditions | Min | Typical | Max | Units |
|--|----------|--|-----|---------|-----|-------|
| RF (Port 1) Frequency Range | | | 5 | | 20 | GHz |
| LO (Port 2) Frequency Range | | | 5 | | 20 | |
| I (Port 3) Frequency Range | | | 0 | | 6 | |
| Q (Port 4) Frequency Range | | | 0 | | 6 | |
| Conversion Loss (CL) ² | | RF/LO = 5 - 20 GHz I = DC - 0.2 GHz | | 12 | 14 | dB |
| | | RF/LO = 5 - 20 GHz I = 0.2 - 6 GHz | | 14 | | |
| | | RF/LO = 5 - 20 GHz Q = DC - 0.2 GHz | | 12 | 14 | |
| | | RF/LO = 5 - 20 GHz Q = 0.2 - 6 GHz | | 14 | | |
| Noise Figure (NF) ³ | | RF/LO = 5 - 20 GHz I = DC - 0.2 GHz | | 12 | | dB |
| | | RF/LO = 5 - 20 GHz Q = DC - 0.2 GHz | | 12 | | |
| Image Rejection (IR) ⁴ | | RF/LO = 5 - 20 GHz I+Q = DC - 0.2 GHz | | 35 | | dBc |
| Amplitude Balance ⁵ | | | | 0.3 | | dB |
| Phase Balance | | | | 2 | | ° |
| Isolation | LO to RF | RF/LO = 5 - 20 GHz | | 39 | | dB |
| | LO to IF | IF/LO = 5 - 20 GHz | | 50 | | |
| | RF to IF | RF/IF = 5 - 20 GHz | | 37 | | |
| Input IP3 (IIP3) ⁶ | I+Q | RF/LO = 5 - 20 GHz I = DC - 0.2 GHz | | 25 | | dBm |
| Input 1 dB Gain Compression Point (P1dB) | I | | | 11 | | dBm |
| | Q | | | 11 | | |

² Measured as an I/Q down converter (i.e., I and Q powers are not combined)

³ Mixer Noise Figure typically measures within 0.5 dB of conversion loss for IF frequencies greater than 5 MHz.

⁴ Image Rejection and Single sideband performance plots are defined by the upper sideband (USB) or lower sideband (LSB) with respect to the LO signal. Plots are defined by which sideband is selected by the external IF quadrature hybrid.

⁵ Amplitude and phase balance measured in a down conversion.

⁶ Typical IIP3 is measured with I and Q ports combined with an external quadrature hybrid coupler in a down conversion.

3.6 Typical Performance Plots

| Parameter | | Pin | Start | Nominal | Stop | Units |
|--------------------------------------|------------------|-----|-------|---------|--------|-------|
| RF Input Frequency | | 16 | 0 | | 26 | GHz |
| RF Input Power | | | | -10 | | dBm |
| LO Input Frequency | | 23 | 0.091 | | 26.091 | GHz |
| LO Input Power | | | | +19 | | dBm |
| IF Output Frequency | I | 10 | | 91 | MHz | |
| | Q | 12 | | 91 | | |
| | I+Q ⁷ | 3+4 | | 91 | | |
| T _A , Ambient Temperature | | | | +25 | | °C |
| Z ₀ , System Impedance | | | | 50 | | Ω |

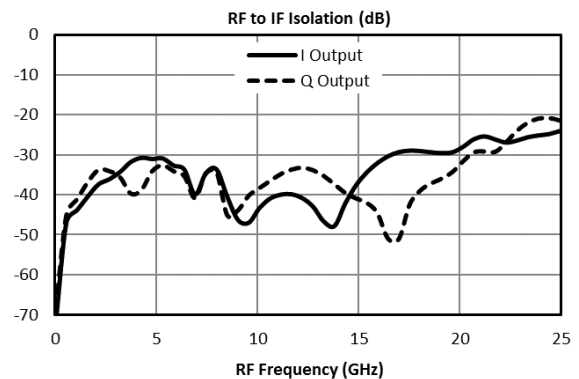
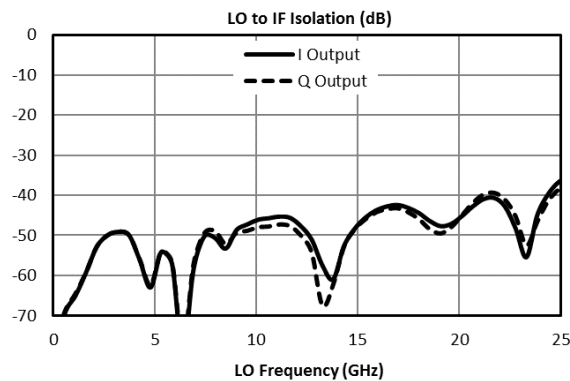
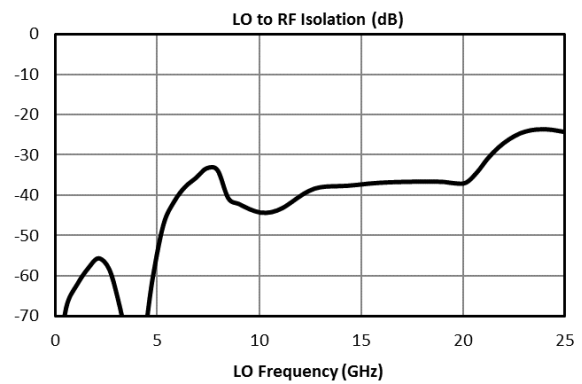
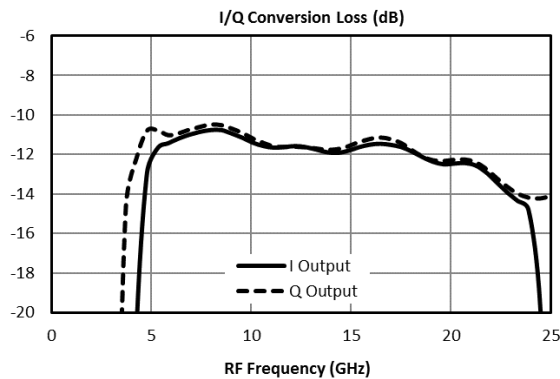

⁷ I+Q measurements taken with an external quadrature hybrid attached to the I and Q ports of the mixer. Orientation depends on up conversion or down conversion measurement.

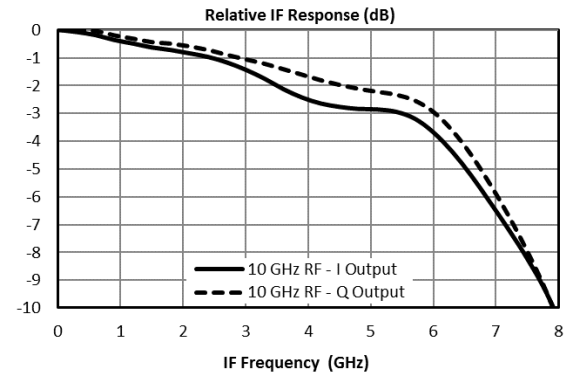
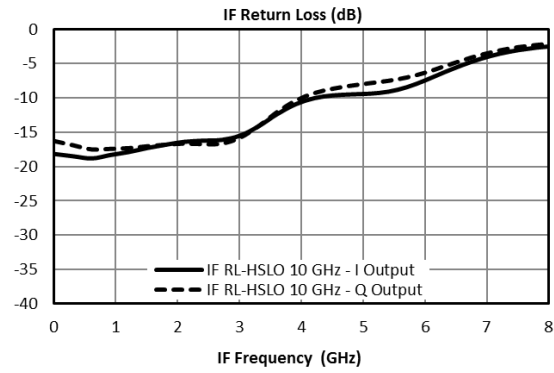
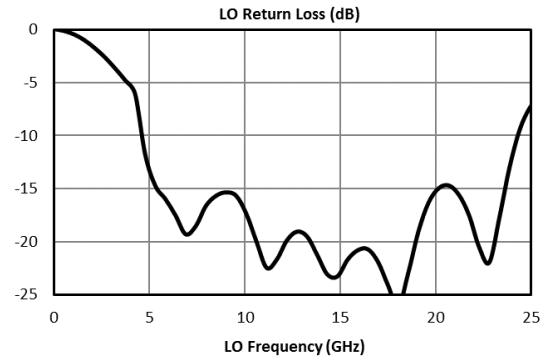
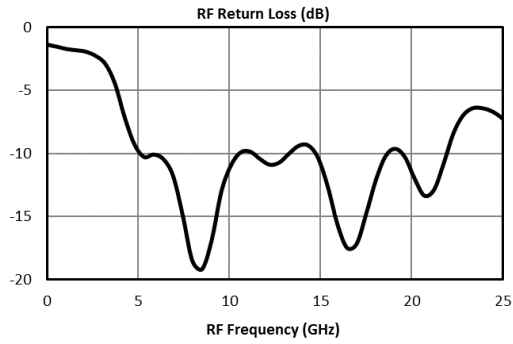

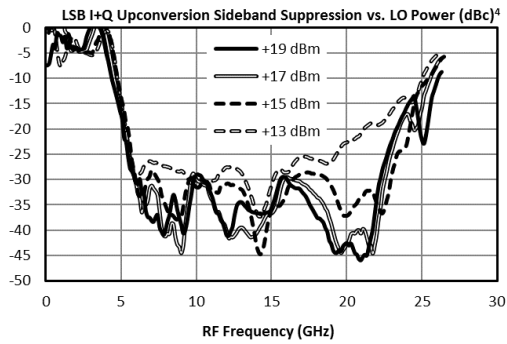
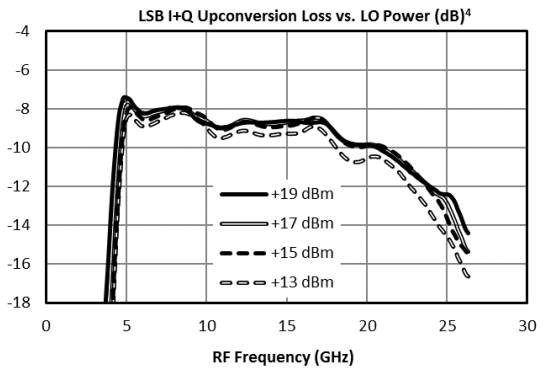
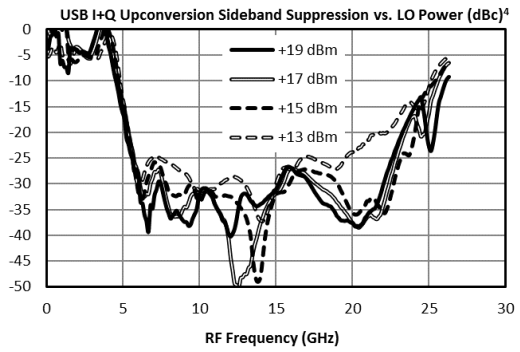
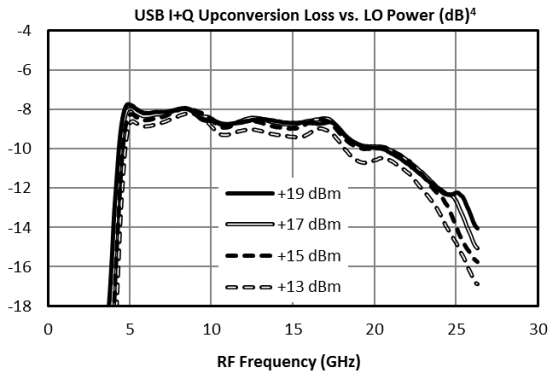
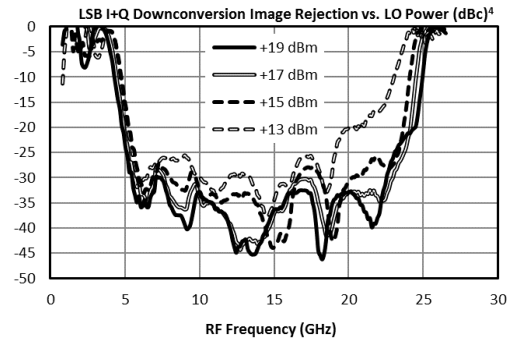
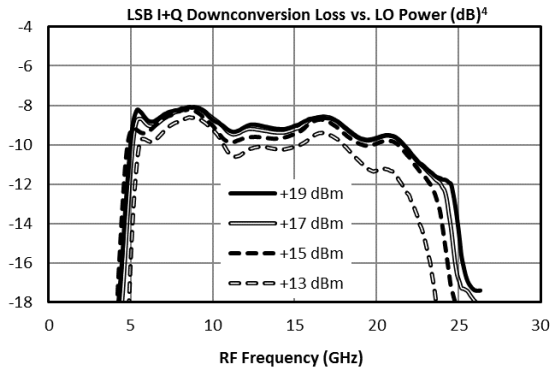
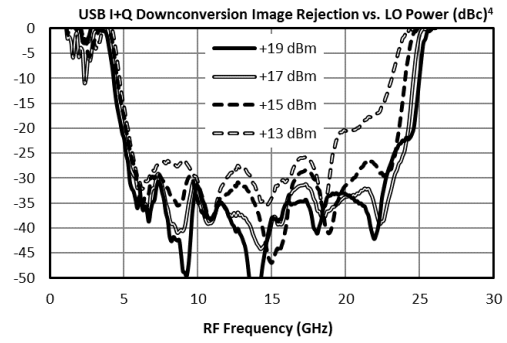
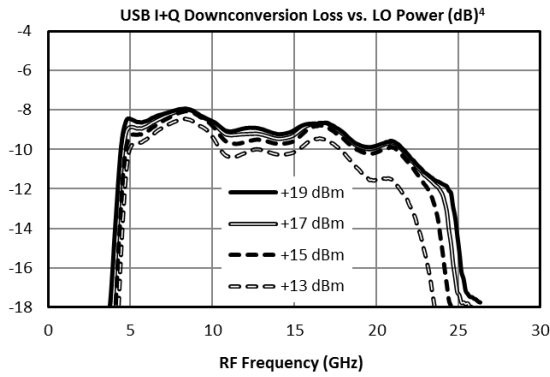

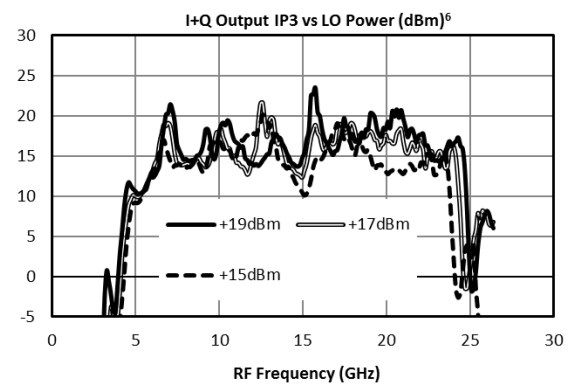
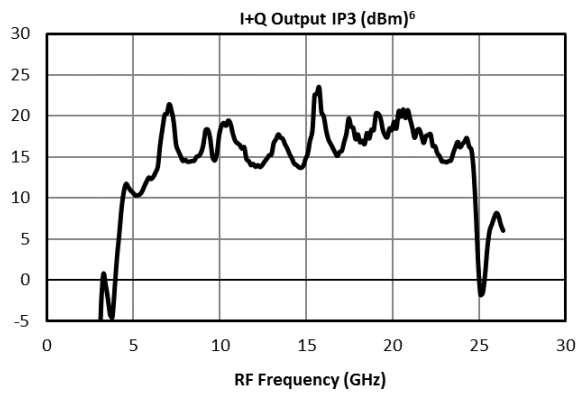
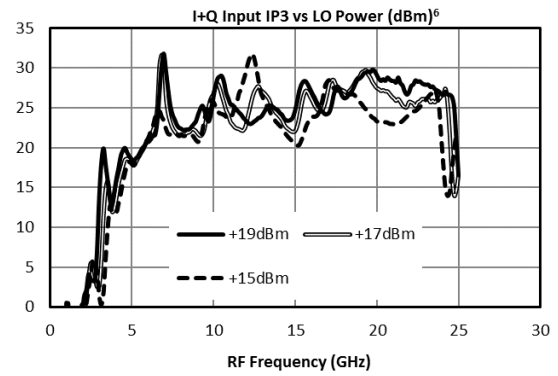
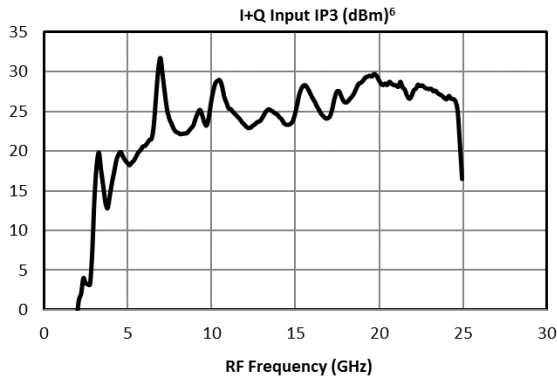
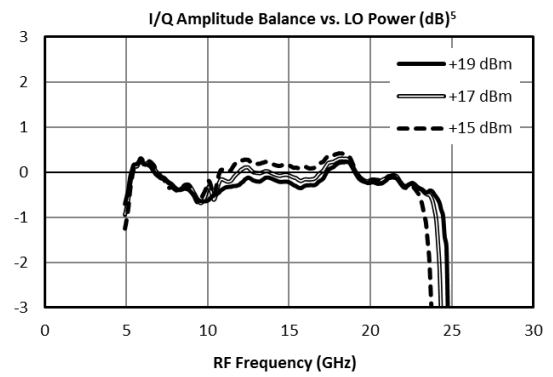
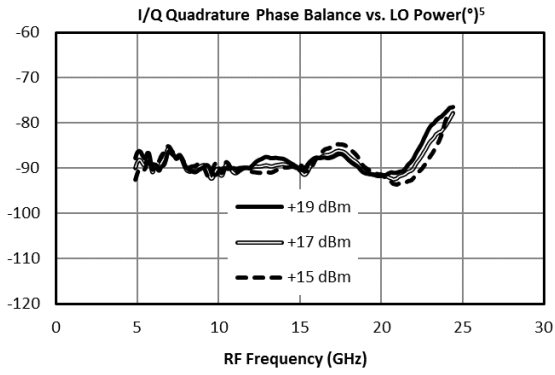

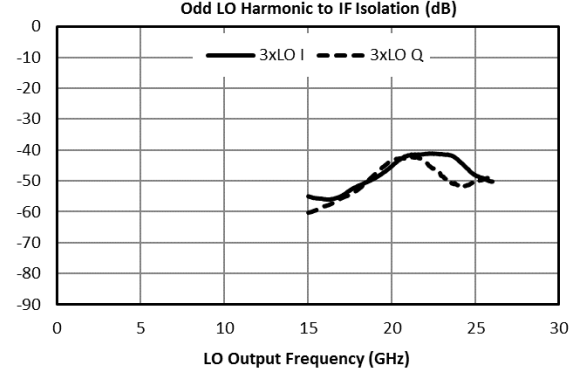
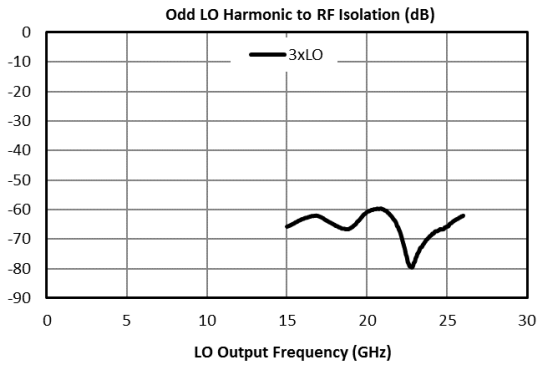
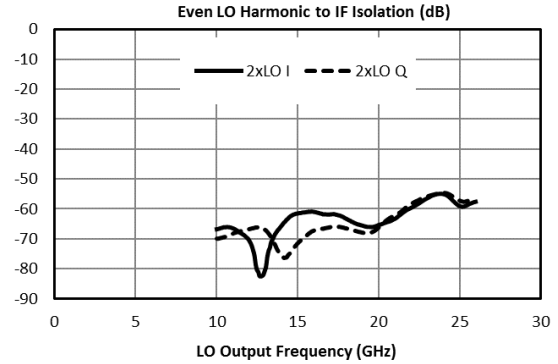
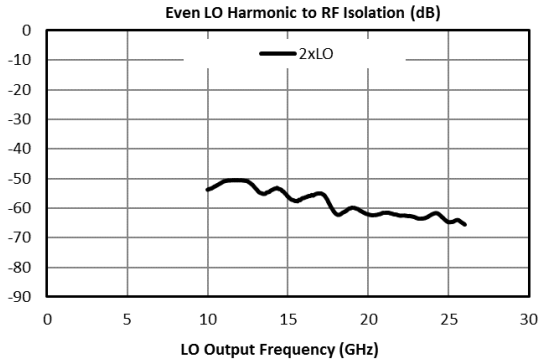

3.6.5 Typical Spurious Performance: Down-Conversion

Typical spurious data is provided by selecting RF and LO frequencies ($\pm m \cdot LO \pm n \cdot RF$) within the RF/LO bands, to create a spurious output within the IF band. The mixer is swept across the full spurious band and the mean is calculated. The numbers shown in the table below are for a -10 dBm RF input. Spurious suppression is scaled for different RF power levels by $(n-1)$, where "n" is the RF spur order. For example, the 2RF x 2LO spur is 79 dBc for a -10 dBm input, so a -20 dBm RF input creates a spur that is $(2-1) \times (-10 \text{ dB})$ lower, or 89 dBc.

Typical Down-conversion spurious suppression (dBc): I Port (Q Port)

| -10 dBm RF Input | 0xLO | 1xLO | 2xLO | 3xLO | 4xLO | 5xLO |
|------------------|----------|-----------|-----------|-----------|-----------|-----------|
| 0xRF | - | 48 (49) | 60 (62) | 58 (56) | 75 (76) | N/A |
| 1xRF | 37 (42) | Reference | 49 (42) | 52 (56) | 45 (54) | N/A |
| 2xRF | 76 (80) | 61 (63) | 79 (79) | 65 (66) | 79 (81) | 74 (65) |
| 3xRF | 100 (97) | 55 (54) | 97 (97) | 77 (79) | 97 (100) | 74 (76) |
| 4xRF | 93 (103) | 75 (77) | 102 (112) | 116 (117) | 118 (121) | 115 (117) |
| 5xRF | N/A | N/A | 108 (115) | 125 (132) | 134 (136) | 128 (132) |

3.6.6 Typical Spurious Performance: Up-Conversion

Typical spurious data is taken by mixing an input within the IF band, with LO frequencies ($\pm m \cdot LO \pm n \cdot IF$), to create a spurious output within the RF output band. The mixer is swept across the full spurious output band and the mean is calculated. The numbers shown in the table below are for a -10 dBm IF input. Spurious suppression is scaled for different IF input power levels by $(n-1)$, where "n" is the IF spur order. For example, the 2IFx1LO spur is typically 41 dBc for a -10 dBm input with a sine-wave LO, so a -20 dBm IF input creates a spur that is $(2-1) \times (-10 \text{ dB})$ lower, or 51 dBc.

Typical Up-conversion spurious suppression (dBc): I Port (Q Port)

| -10 dBm IF Input | 0xLO | 1xLO | 2xLO | 3xLO | 4xLO | 5xLO |
|------------------|-----------|-----------|-----------|----------|-----------|-----------|
| 0xIF | - | 44 (49) | 60 (60) | 65 (65) | 66 (66) | N/A |
| 1xIF | 37 (42) | Reference | 38 (34) | 27 (14) | 69 (73) | N/A |
| 2xIF | 65 (65) | 41 (41) | 63 (65) | 76 (66) | 103 (102) | 96 (82) |
| 3xIF | 88 (75) | 54 (55) | 83 (85) | 70 (60) | 111 (97) | 98 (83) |
| 4xIF | 111 (112) | 84 (84) | 100 (106) | 99 (90) | 118 (106) | 129 (112) |
| 5xIF | 109 (114) | 108 (109) | 126 (126) | 105 (98) | 139 (130) | 125 (116) |

4. Mechanical Data

4.1 SM Package Outline Drawing

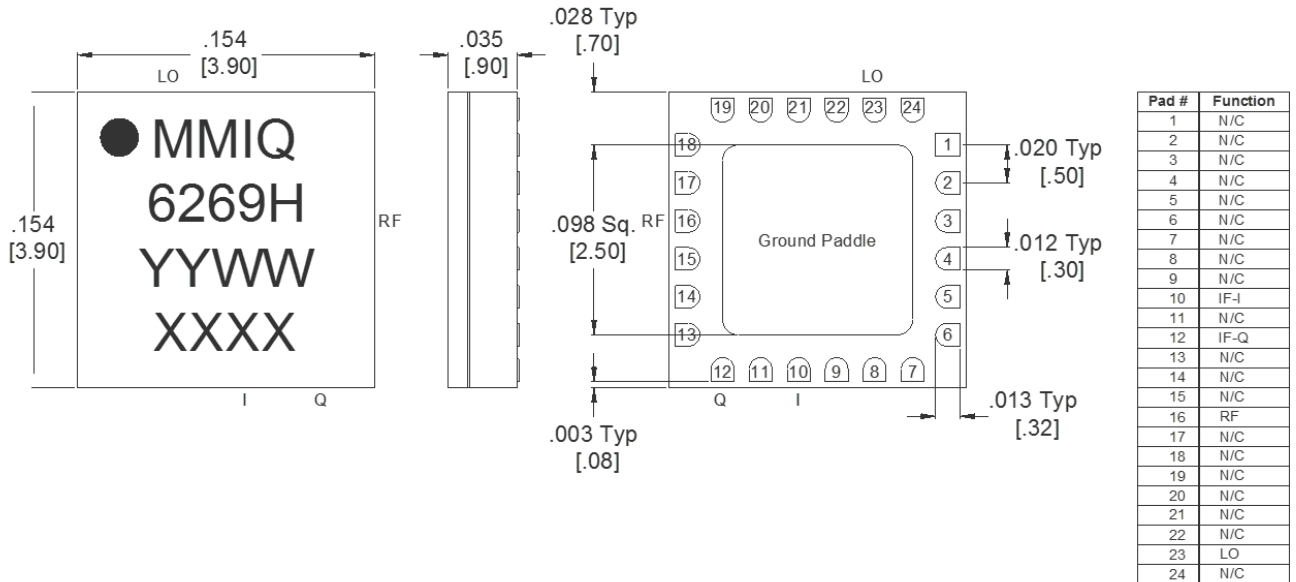

- Substrate material is ceramic.
- I/O Leads and Ground Paddle plating is (from base to finish):

| | | |
|-----|-------------|------------|
| Ni: | 8.89um MAX | 1.27um MIN |
| Pd: | 0.17um MAX | 0.07um MIN |
| Au | 0.254um MAX | 0.03um MIN |
- All unconnected pads should be connected to PCB RF ground.

4.2 SM Package Footprint

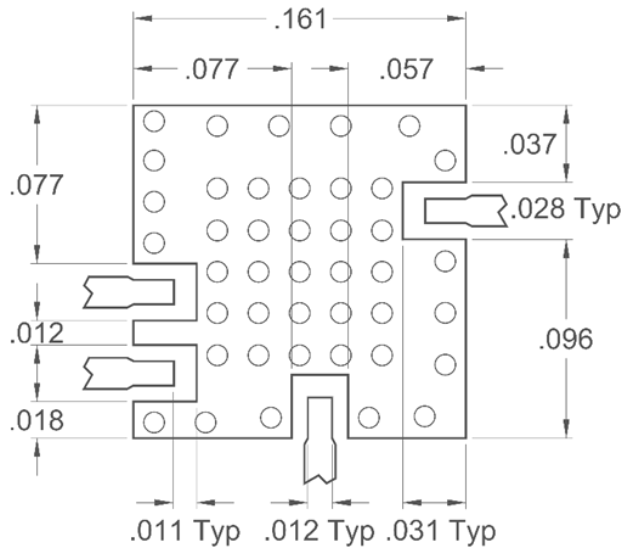

QFN-Package Surface-Mount Landing Pattern

[Click here for a DXF of the above layout.](#)

[Click here for leaded solder reflow.](#) [Click here for lead-free solder reflow](#)

4.3 Evaluation Board Outline Drawing

| Port | Connector Type |
|------|----------------|
| LO | SMA Female |
| RF | SMA Female |
| I/Q | SMA Female |

Note: Eval Connectors are not removeable.

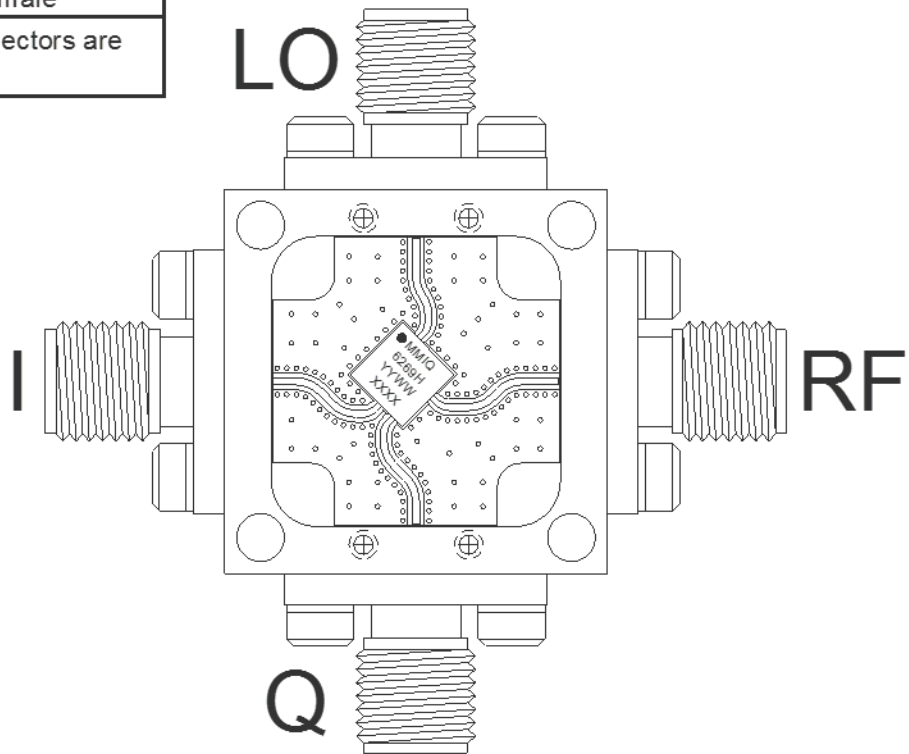

Marki Microwave reserves the right to make changes to the product(s) or information contained herein without notice.
 Marki Microwave makes no warranty, representation, or guarantee regarding the suitability of its products for any particular purpose, nor does Marki Microwave assume any liability whatsoever arising out of the use or application of any product.