

MMIC Double-Balanced I/Q Mixer

MMIQ-0205HSM

Page 1

The MMIQ-0205HSM is a miniaturized, surface-mount multi-octave 1.75-5.0 GHz IQ mixer. It features matched double balanced mixers connected with an integrated LO hybrid and RF power divider. It can be used for either upconversion or downconversion. Applications include communications or radar systems with advanced digital modulation formats and phase modulated signals, test and measurement, or electronic warfare. Image reject or single sideband modulation with excellent suppression is possible with use of an external IF quadrature (90°) hybrid.



Features

- 5mm QFN Surface-Mount Package
- CAD Optimized for Superior Isolation, Spurious Response, and Image Rejection/Sideband Suppression
- Broadband Performance
- Excellent Unit-to-Unit Repeatability
- Fully nonlinear software models available with Marki Circuit Models for Microwave Office
- RoHS Compliant

Electrical Specifications - Specifications guaranteed from -55 to +100°C, measured in a 50Ω system.

Parameter	LO (GHz)	RF (GHz)	IF (GHz)	Min	Typ	Max	Diode Option LO drive level (dBm)
Conversion Loss (dB) (Combined IF with Test Hybrid)	1.75-5.0		DC-0.2		8.0	10.5	+14 to +20
Image Rejection (dB) (Combined IF with Test Hybrid)			0.2-2.0		See Plots		
I/Q Amplitude Balance (dB)					0.16		
I/Q Quadrature Phase Balance (Degrees)					3		
Isolation (dB) LO-RF LO-IF RF-IF			DC-2.0		See Plots		
Input 1 dB Compression (dBm) (Combined IF with Test Hybrid)					+12		
Input Two-Tone Intercept (dBm) (Combined IF with Test Hybrid)					+20		

Part Number Options

Model Number	Description
MMIQ-0205HSM-2 ¹	Surface Mount
EVAL-MMIQ-0205H	Connectorized Evaluation Fixture

¹ For port locations and I/O designations, refer to the drawing on page 3 of this document.

MMIC Double-Balanced I/Q Mixer

MMIQ-0205HSM

Page 2

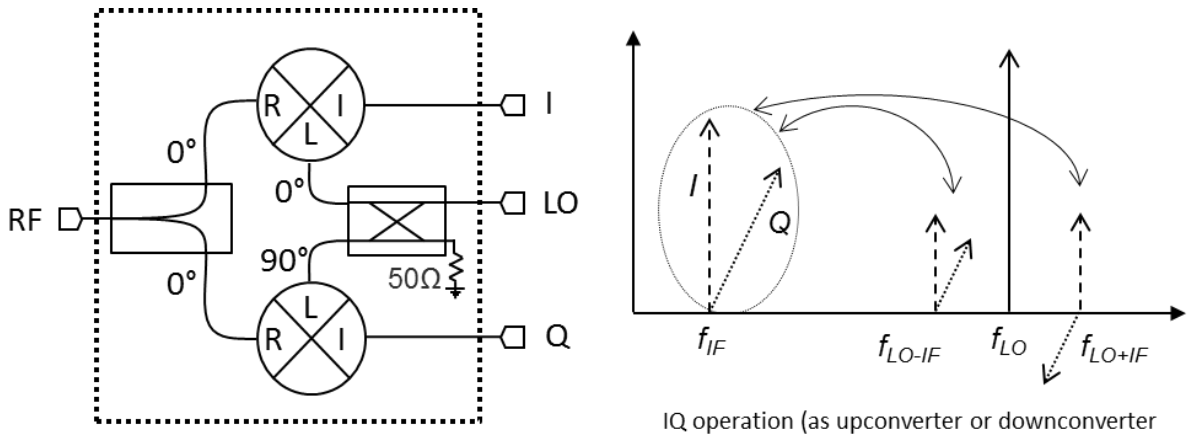

Figure 1a. I/Q Mixer Schematic

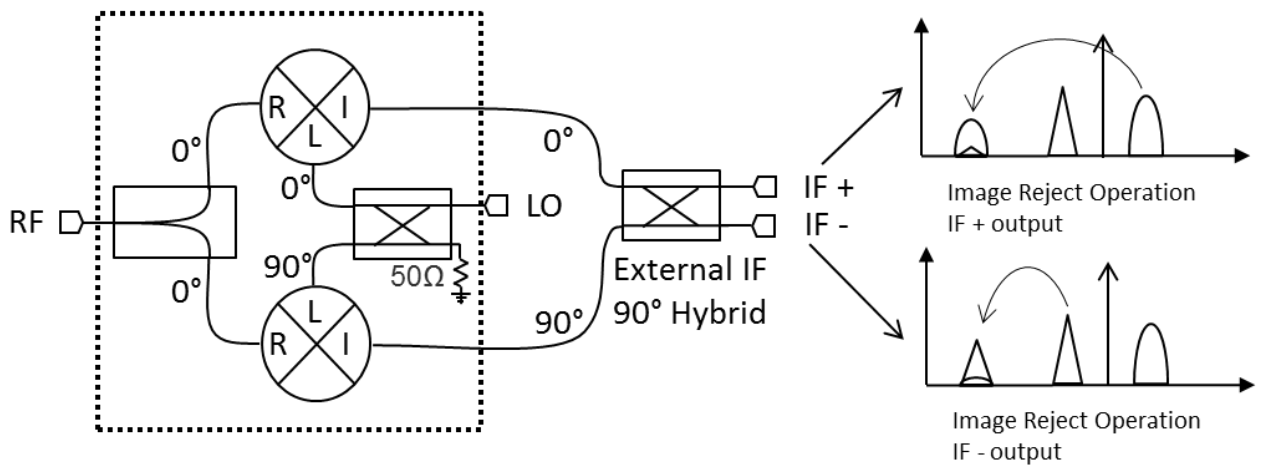
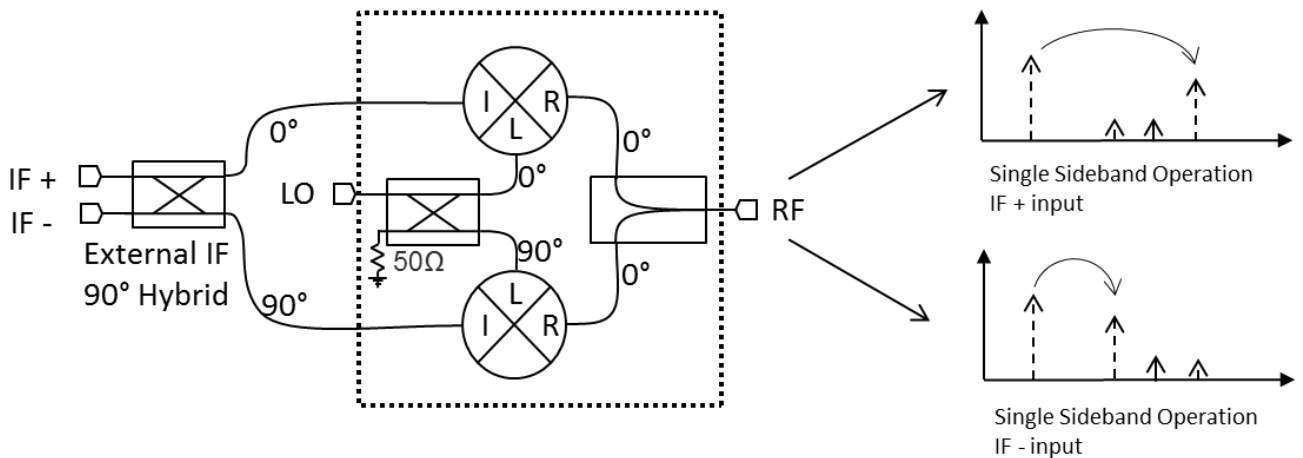

Figure 1b. Image Reject Mixer Schematic



MMIC Double-Balanced I/Q Mixer

MMIQ-0205HSM

Page 3

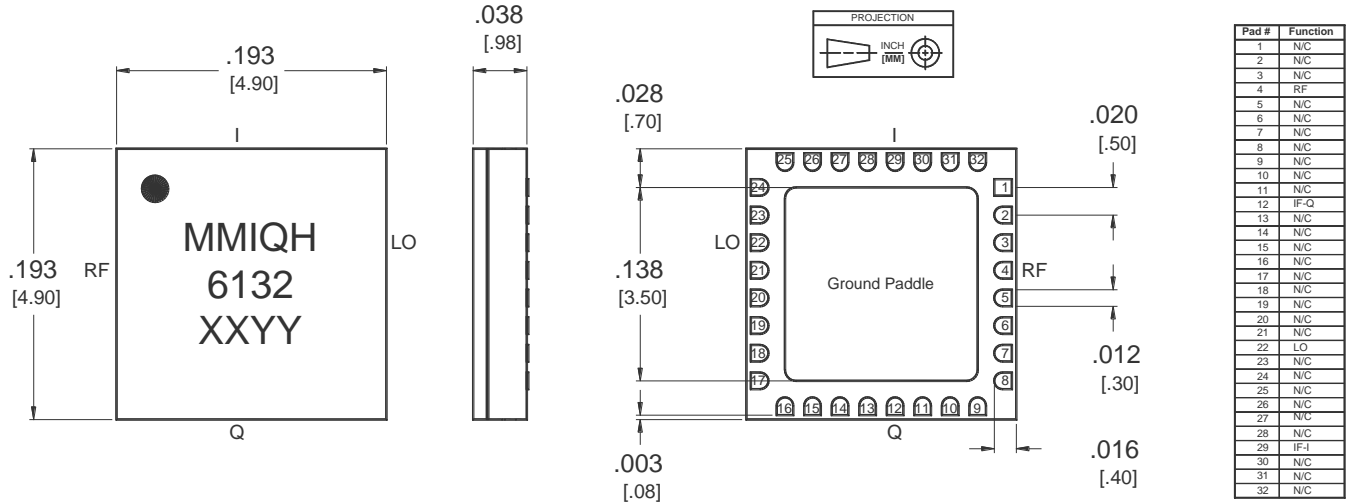

Outline Drawing – 5mm QFN Package

Substrate material is Ceramic.

I/O Leads and Ground Paddle are 1.4±0.6 microns (55±24 micro-inches) Au over 1.3 microns (51 micro-inches) Ni.

All unconnected pads should be connected to PCB RF ground.

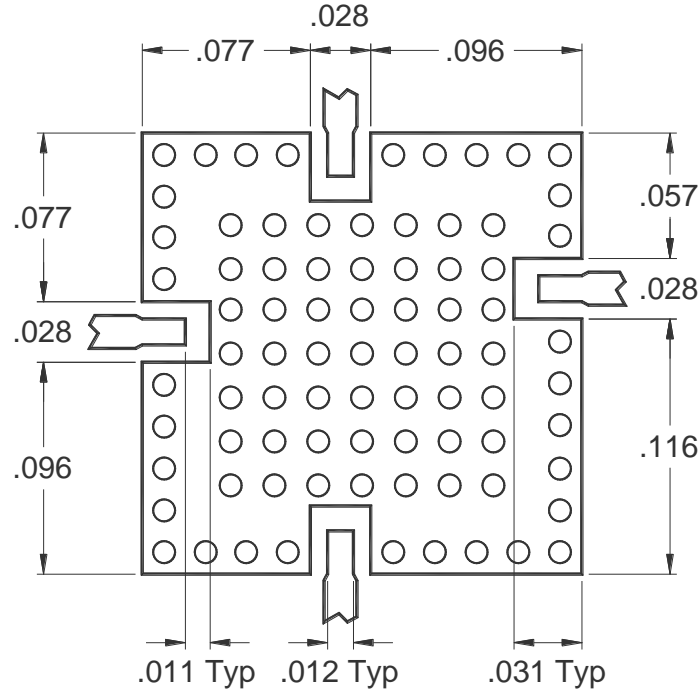

QFN-Package Surface-Mount Landing Pattern

[Click here for a DXF of the above layout.](#)

[Click here for leaded solder reflow.](#) [Click here for lead-free solder reflow](#)

MMIC Double-Balanced I/Q Mixer

MMIQ-0205HSM

Page 4

Typical Performance

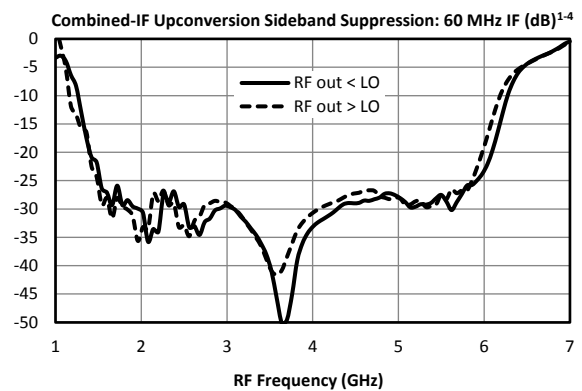
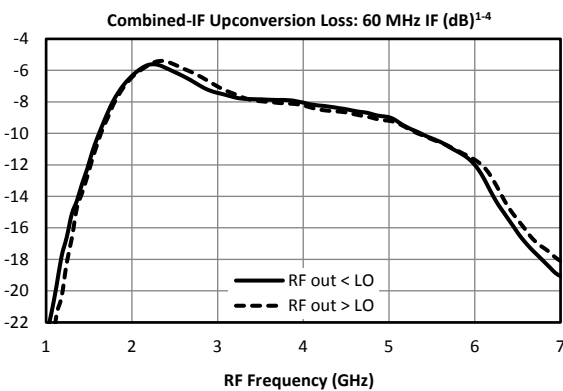
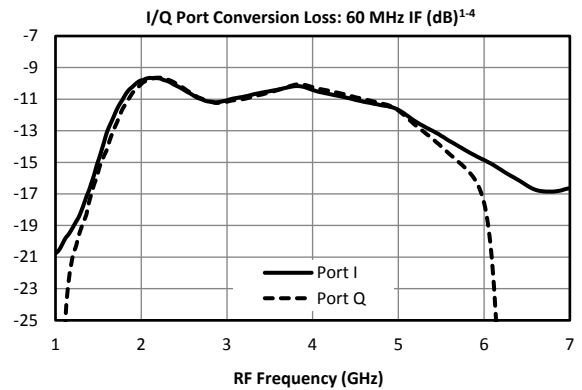
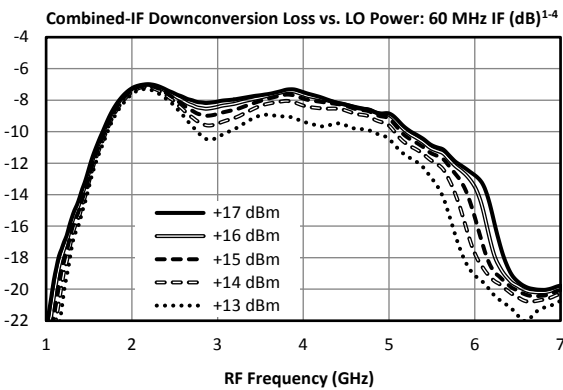
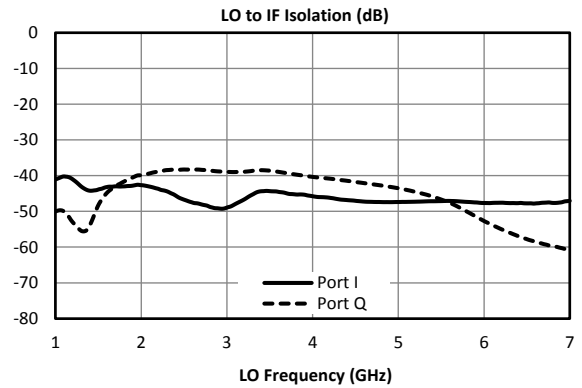
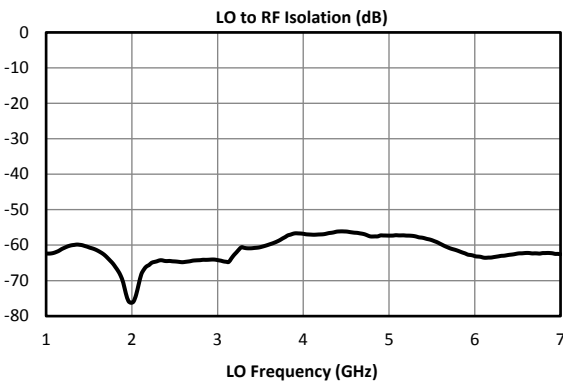
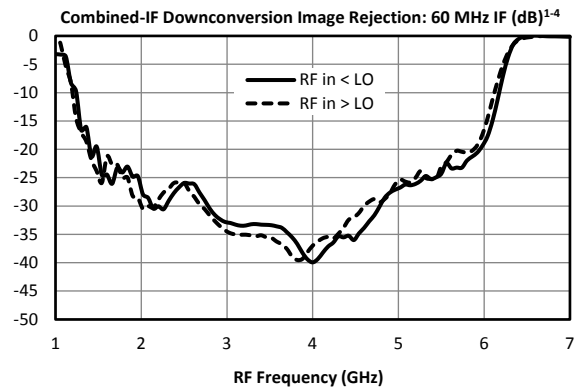
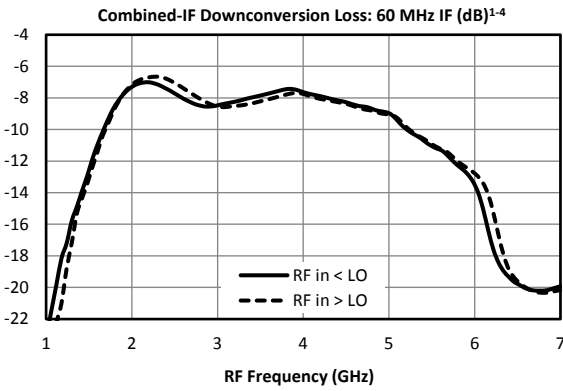

MMIC Double-Balanced I/Q Mixer

MMIQ-0205HSM

Page 5

Typical Performance

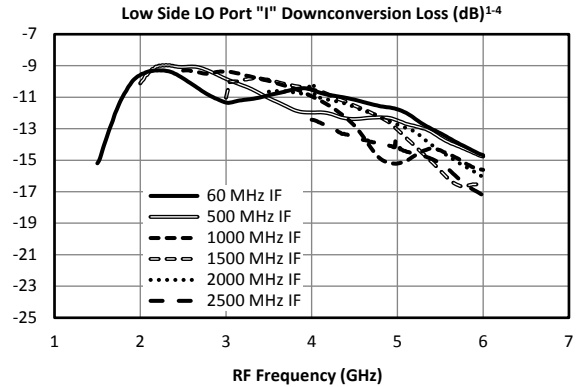
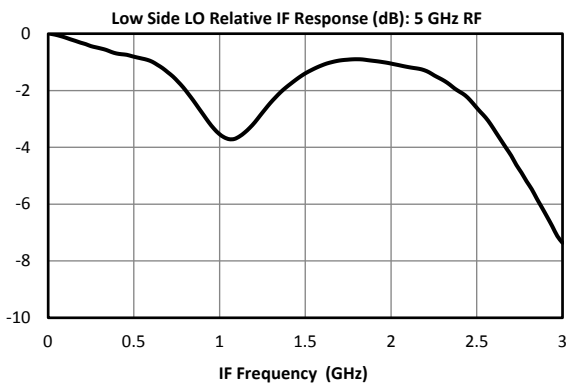
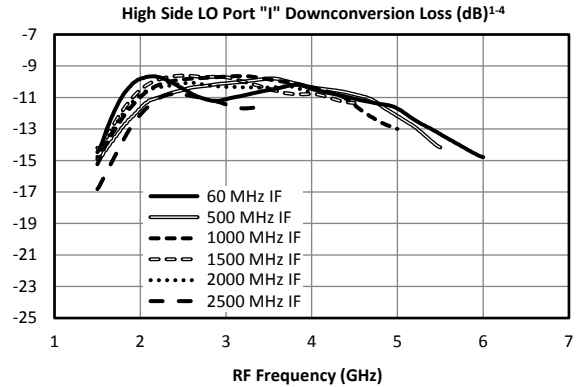
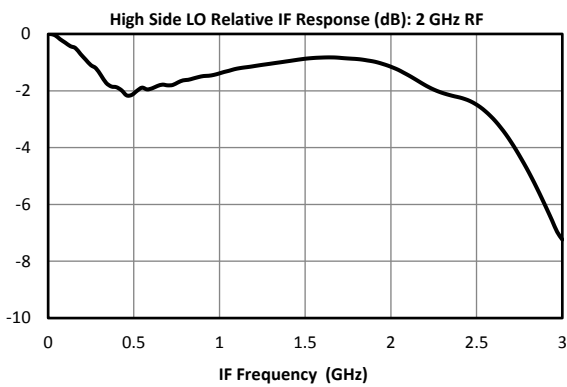
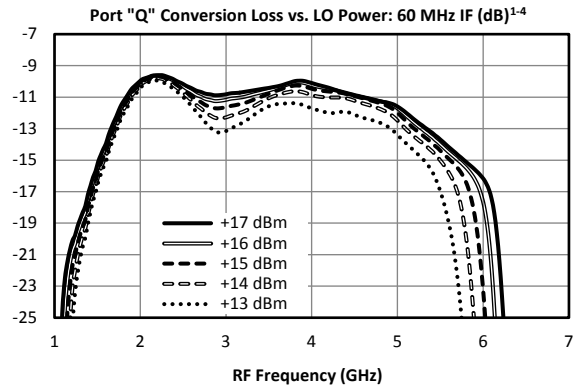
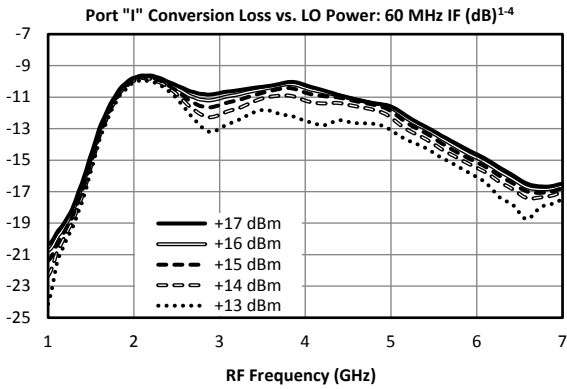
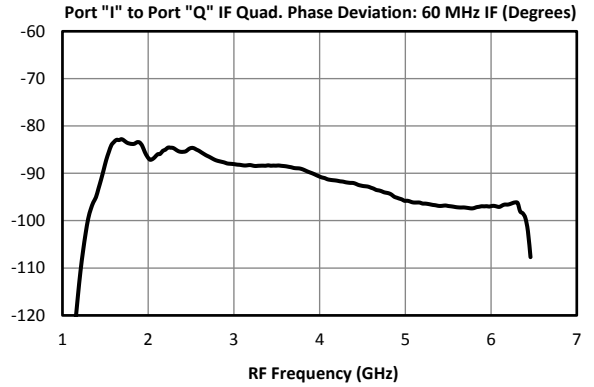
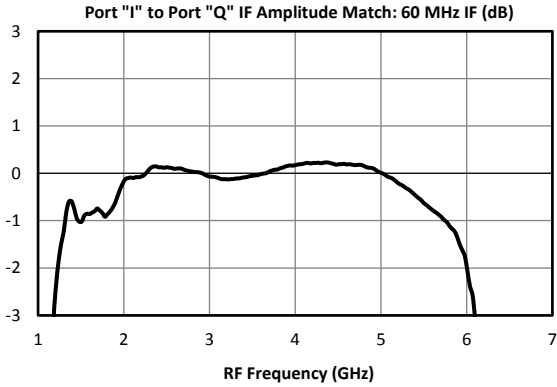

MMIC Double-Balanced I/Q Mixer

MMIQ-0205HSM

Page 6

Typical Performance

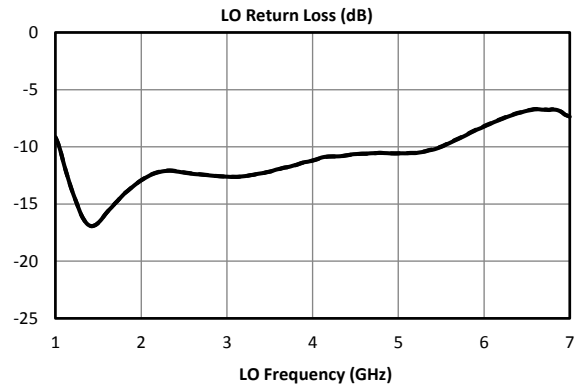
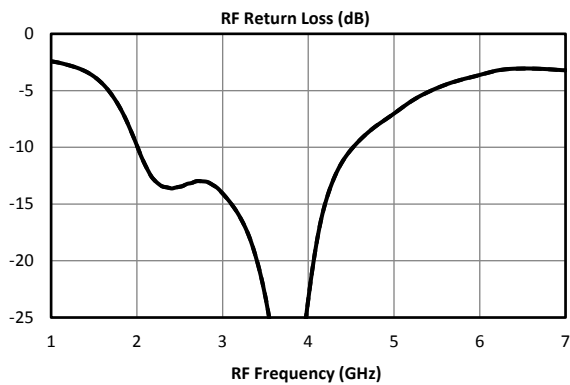
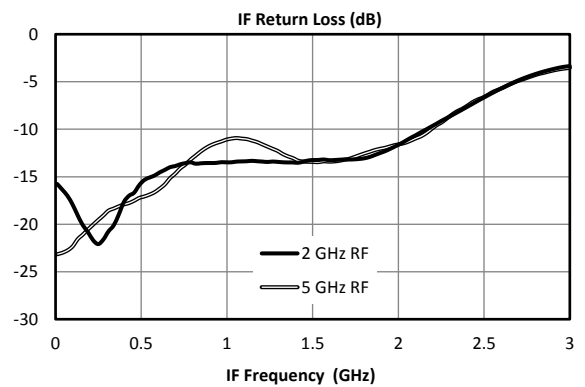
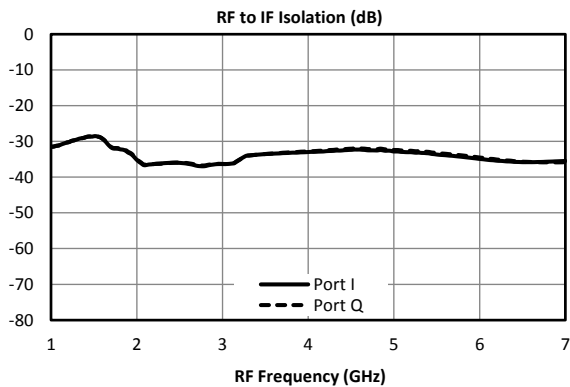
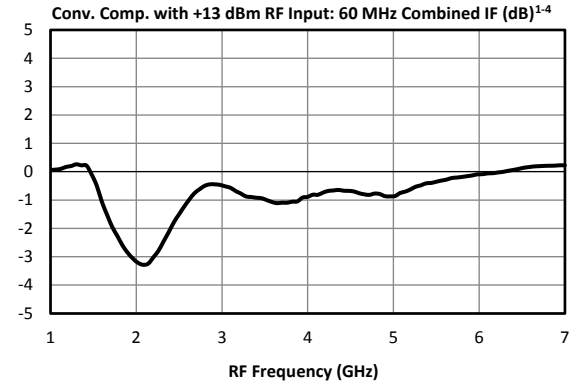
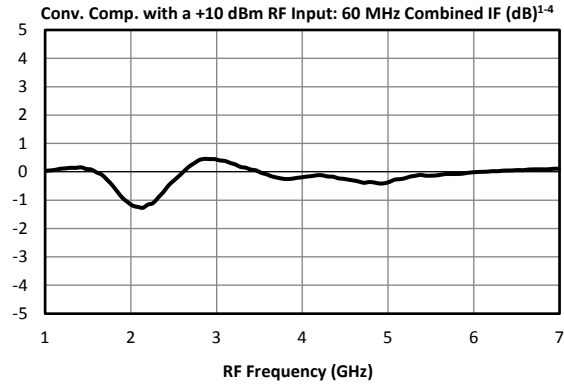
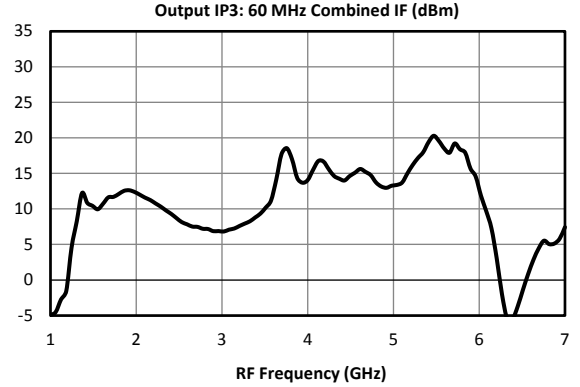
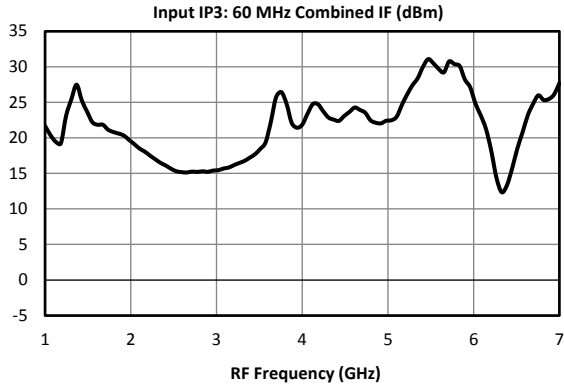

MMIC Double-Balanced I/Q Mixer

MMIQ-0205HSM

Page 7

Typical Performance

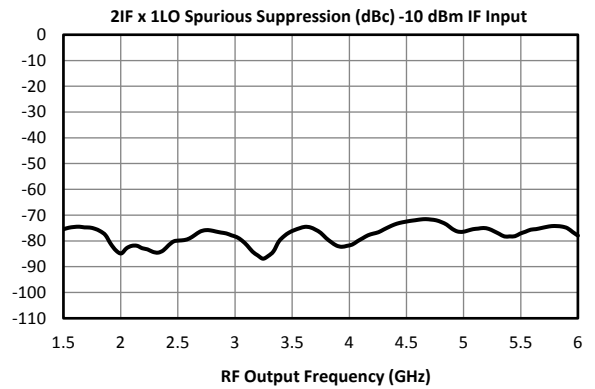
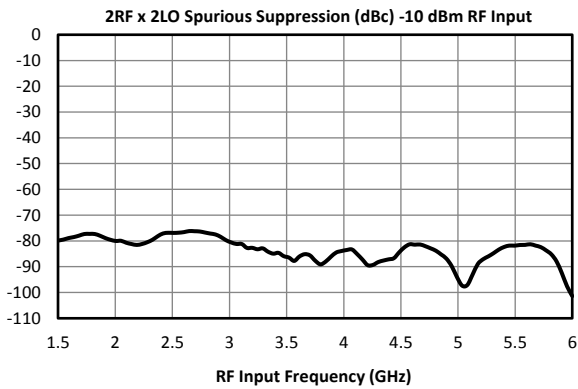
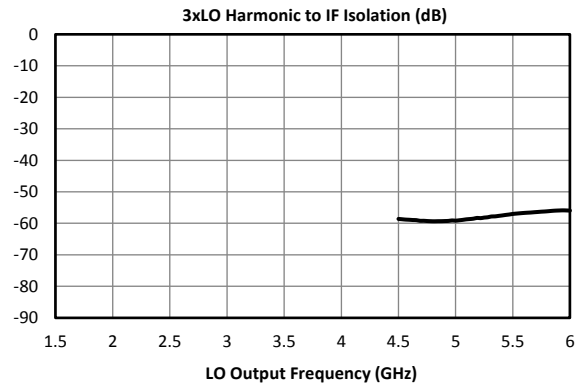
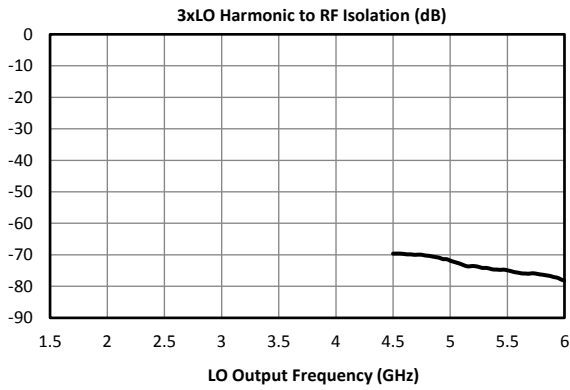
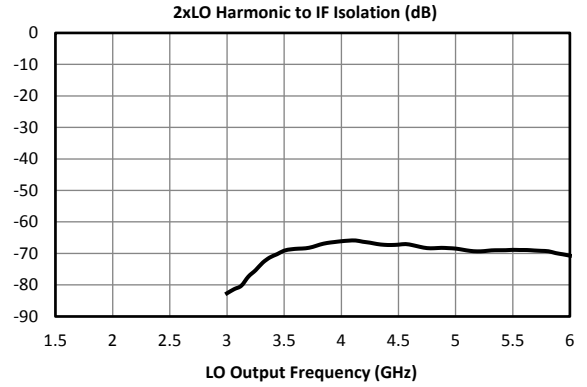
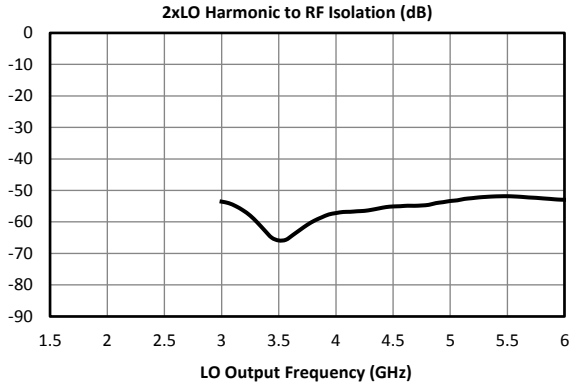

Downconversion Spurious Suppression

Spurious data is taken by selecting RF and LO frequencies ($\pm mLO \pm nRF$) within the RF/LO bands, to create a spurious output within the IF band. The mixer is swept across the full spurious band and the mean is calculated. The numbers shown in the table below are for a -10 dBm RF input. Spurious suppression is scaled for different RF power levels by (n-1), where “n” is the RF spur order. For example, the 2RFx2LO spur is 83 dBc for a -10 dBm input, so a -20 dBm RF input creates a spur that is (2-1) x (-10 dB) dB lower, or 93 dBc.

Typical Downconversion Spurious Suppression (dBc) ⁴

-10 dBm RF Input	0xLO	1xLO	2xLO	3xLO	4xLO	5xLO
1xRF	23	Reference	42	15	55	18
2xRF	91	63	83	64	78	67
3xRF	92	76	88	68	94	68
4xRF	142	110	118	109	119	103
5xRF	155	126	134	121	129	115

Upconversion Spurious Suppression

Spurious data is taken by mixing an input within the IF band, with LO frequencies ($\pm mLO \pm nIF$), to create a spurious output within the RF output band. The mixer is swept across the full spurious output band and the mean is calculated. The numbers shown in the table below are for a -10 dBm IF input. Spurious suppression is scaled for different IF input power levels by (n-1), where “n” is the IF spur order. For example, the 2IFx1LO spur is typically 78 dBc for the A configuration for a -10 dBm input, so a -20 dBm IF input creates a spur that is (2-1) x (-10 dB) dB lower, or 88 dBc.

Typical Upconversion Spurious Suppression (dBc) ⁴

-10 dBm IF Input	0xLO	1xLO	2xLO	3xLO	4xLO	5xLO
1xIF	23	Reference	39	9	51	33
2xIF	59	78	59	84	59	81
3xIF	92	58	84	54	84	60
4xIF	107	124	97	120	101	120
5xIF	135	103	127	106	123	103

MMIC Double-Balanced I/Q Mixer

MMIQ-0205HSM

Page 9

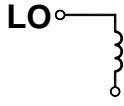
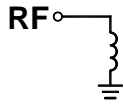
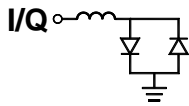
Port	Description	DC Interface Schematic
LO	The LO port is DC open and AC matched to 50 Ohms from 1.75 to 5 GHz. Blocking capacitor is optional.	
RF	The RF port is DC short to ground and AC matched to 50 Ohms from 1.75 to 5 GHz. Blocking capacitor is optional.	
I/Q	The I/Q ports are DC coupled to the diodes. Blocking capacitor is optional.	

Absolute Maximum Ratings	
Parameter	Maximum Rating
RF DC Current	30 mA
LO DC Current	N/A
IF DC Current ¹	30 mA
RF Power Handling (RF+LO)	+26 dBm at +25°C, derated linearly to +23 dBm at +100°C
Operating Temperature	-55°C to +100°C
Storage Temperature	-65°C to +125°C

¹Application of DC current has been known to damage mixer diodes. Any application of DC current >30 mA could cause field damage and void the warranty.

DATA SHEET NOTES:

- Mixer Conversion Loss, Rejection, Sideband Suppression, and IP3 plot IF frequency is 60 MHz.
- Mixer Noise Figure typically measures within 0.5 dB of conversion loss for IF frequencies greater than 5 MHz.
- Conversion Loss typically degrades less than 0.5 dB at +100°C and improves less than 0.5 dB at -55°C.
- Unless otherwise specified H diode data taken with +16 dBm LO drive
- Specifications are subject to change without notice. Contact Marki Microwave for the most recent specifications and data sheets.
- Catalog mixer circuits are continually improved. Configuration control requires custom mixer model numbers and specifications.

Marki Microwave reserves the right to make changes to the product(s) or information contained herein without notice. Marki Microwave makes no warranty, representation, or guarantee regarding the suitability of its products for any particular purpose, nor does Marki Microwave assume any liability whatsoever arising out of the use or application of any product.

© Marki Microwave, Inc.

