

## GaAs MMIC Millimeter Wave Doubler

## MMD-2050HSM

### 1. Device Overview

#### 1.1 General Description

The MMD-2050HSM is a passive MMIC millimeter wave doubler fabricated with GaAs Schottky diodes. This operates over a guaranteed 10 to 25 GHz input frequency range or a doubled output frequency range of 20 to 50 GHz. It features excellent conversion loss, superior isolations, and high harmonic suppressions across a broad bandwidth. Both surface mount QFN and evaluation boards are available.

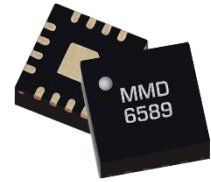

QFN

#### 1.2 Features

- High fundamental rejection
- Millimeter wave output frequencies
- RoHS Compliant
- +10dBm to +15dBm LO drive

#### 1.3 Applications

- High frequency synthesis
- LO signal chain

#### 1.4 Functional Block Diagram



#### 1.5 Part Ordering Options<sup>1</sup>

Part Number	Description	Package	Green Status	Product Lifecycle	Export Classification
MMD-2050HSM	3mm QFN Surface Mount	SM	RoHS	Active	EAR99
EVAL-MMD-2050H	Connectorized Evaluation Fixture	Eval		Active	EAR99

<sup>1</sup> Refer to our [website](#) for a list of definitions for terminology presented in this table.

## Table of Contents

1. Device Overview .....	1	3.1 Absolute Maximum Ratings.....	4
1.1 General Description.....	1	3.2 Package Information .....	4
1.2 Features .....	1	3.3 Recommended Operating Conditions .	4
1.3 Applications .....	1	3.4 Sequencing Requirements .....	4
1.4 Functional Block Diagram .....	1	3.5 Electrical Specifications .....	5
1.5 Part Ordering Options.....	1	3.6 Typical Performance Plots .....	6
2. Port Configurations and Functions .....	3	4. Mechanical Data .....	8
2.1 Port Diagram .....	3	4.1 SM Package Outline Drawing .....	8
2.2 Port Functions .....	3	4.2 SM Package Footprint.....	8
3. Specifications .....	4	4.3 EVAL Package Outline Drawing.....	9

## Revision History

Revision Code	Revision Date	Comment
-	February 2020	Initial Release



## 2. Port Configurations and Functions

### 2.1 Port Diagram

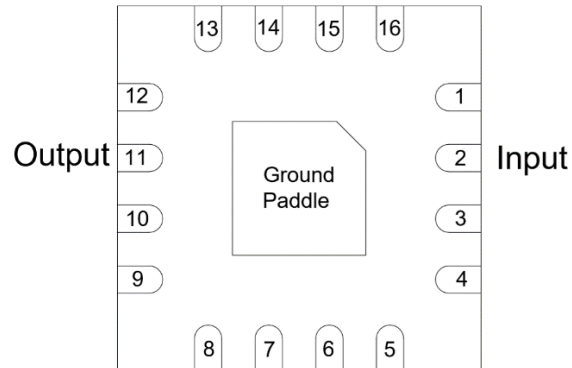
A top-down view of the MMD-2050HSM outline drawing is shown below. The MMD-2050H should only be used in the forward direction, with the input and output ports given in Port Functions.

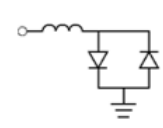

### 2.2 Port Functions

Port	Function	Description	Equivalent Circuit for Package
Pin 2	1F Input	Pin 2 is diode coupled and AC matched to 50 Ohms from 10-25GHz	
Pin 11	2F Output	Pin 11 is DC open and AC matched to 50 Ohms from 20-50GHz	
GND	Ground	SM package ground path is provided through the ground paddle.	

### 3. Specifications

#### 3.1 Absolute Maximum Ratings

The Absolute Maximum Ratings indicate limits beyond which damage may occur to the device. If these limits are exceeded, the device may be inoperable or have a reduced lifetime.

Parameter	Maximum Rating	Units
Power Handling, at any Port	TBD	dBm
Operating Temperature	-55 to +100	°C
Storage Temperature	-65 to +125	°C

#### 3.2 Package Information

Parameter	Details	Rating
ESD	Human Body Model (HBM), per MIL-STD-750, Method 1020	1A
Weight	EVAL Package	TBD

#### 3.3 Recommended Operating Conditions

The Recommended Operating Conditions indicate the limits, inside which the device should be operated, to guarantee the performance given in Electrical Specifications. Operating outside these limits may not necessarily cause damage to the device, but the performance may degrade outside the limits of the electrical specifications. For limits, above which damage may occur, see Absolute Maximum Ratings.

	Min	Nominal	Max	Units
T <sub>A</sub> , Ambient Temperature	-55	+25	+100	°C
Input Power	+10		+15	dBm

#### 3.4 Sequencing Requirements

There is no requirement to apply power to the ports in a specific order. However, it is recommended to provide a 50Ω termination to each port before applying power. This is a passive diode doubler that requires no DC bias.

### 3.5 Electrical Specifications

The electrical specifications apply at  $T_A=+25^\circ\text{C}$  in a  $50\Omega$  system. Typical data shown is for the EVAL package doubler used in the forward direction with a +11 dBm sine wave input.

Min and Max limits apply only to our EVAL units and are guaranteed at  $T_A=+25^\circ\text{C}$ .

Parameter	Test Conditions		Min	Typical	Max	Units
Input (Port 1) Frequency Range			10		25	GHz
Output (Port 2) Frequency Range			20		50	
Input Power			+10		+15	dBm
2F Conversion Loss (CL)	Input = 10 – 25 GHz Output = 20 - 50 GHz			12.5	16	dB
Suppression <sup>2,3</sup>	1F	Input = 10 – 25 GHz Output = 10 - 25 GHz	25	33		dBc
	3F	Input = 10 – 17 GHz Output = 30 - 51 GHz	30	40		
	4F	Input = 10 – 12.5 GHz Output = 40 - 50 GHz	8	10.5		
Isolations <sup>4</sup>	1F	Input = 10 - 25 GHz Output = 10 - 25 GHz	40	45		dB
	3F	Input = 10 – 17 GHz Output = 30 - 51 GHz	42	53		
	4F	Input = 10 – 12.5 GHz Output = 40 - 50 GHz	22	24.5		

<sup>2</sup> Suppressions and isolations measured with an input source with >60dBc (relative to fundamental input) harmonic suppression

<sup>3</sup> Suppression is defined as the harmonic power relative to the 2F doubled output power

<sup>4</sup> Isolation is defined as the harmonic power relative to the 1F fundamental input power.

### 3.6 Typical Performance Plots

All typical performance data includes fixturing losses from the EVAL package. The actual DUT performs better than the displayed results, especially as the frequency increases.

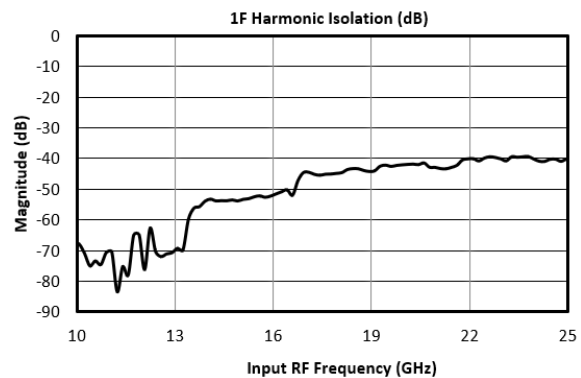
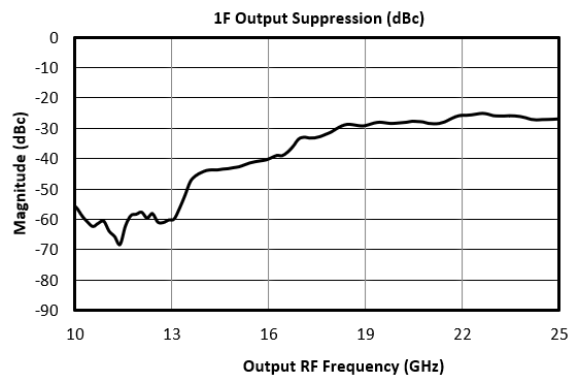
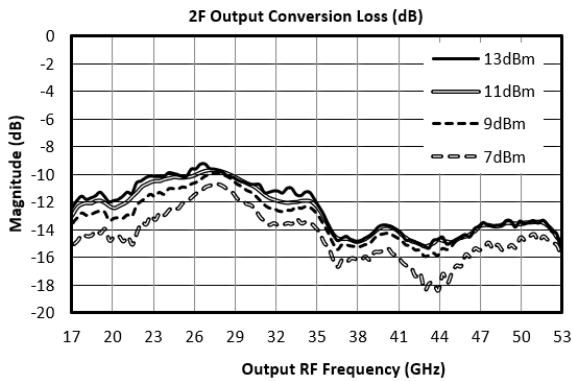
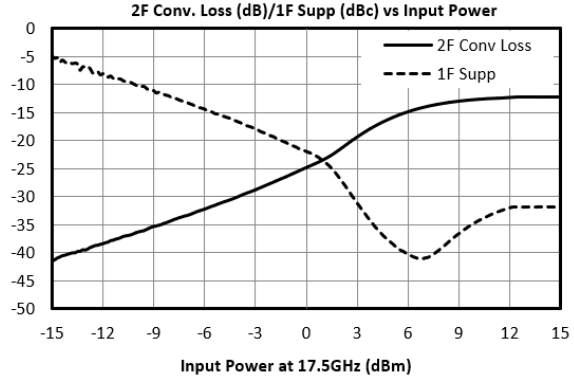
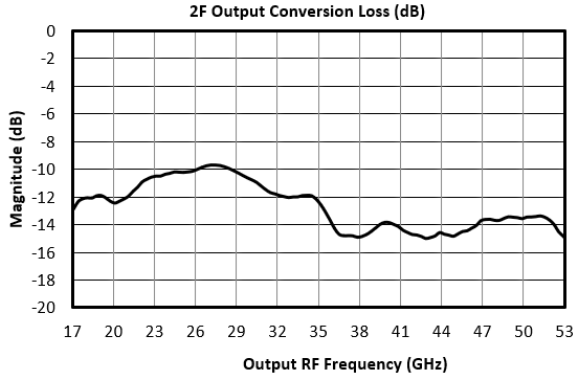

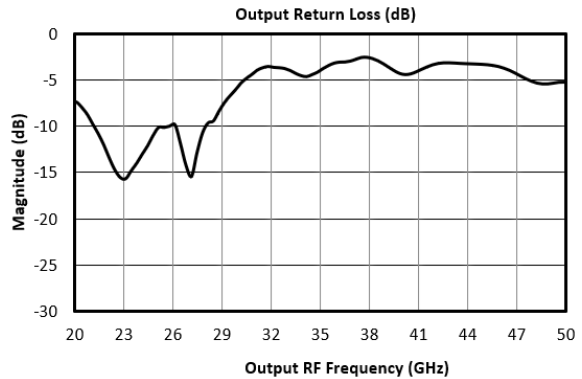
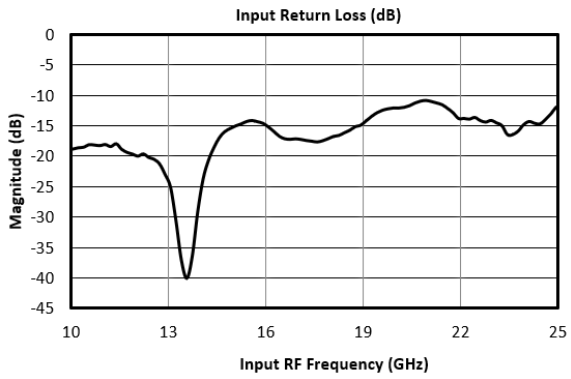
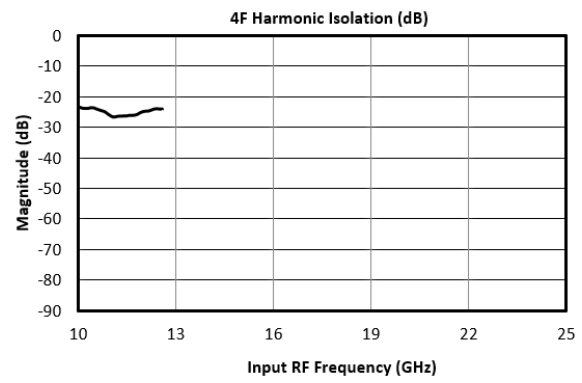
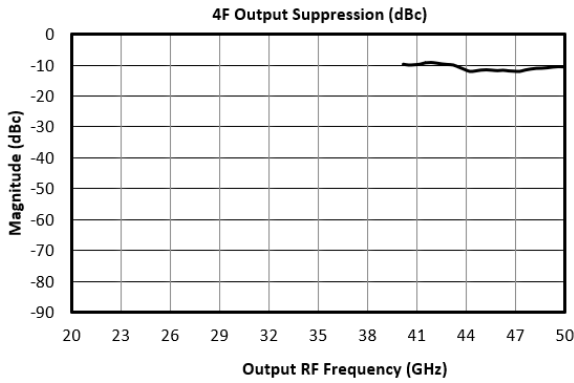
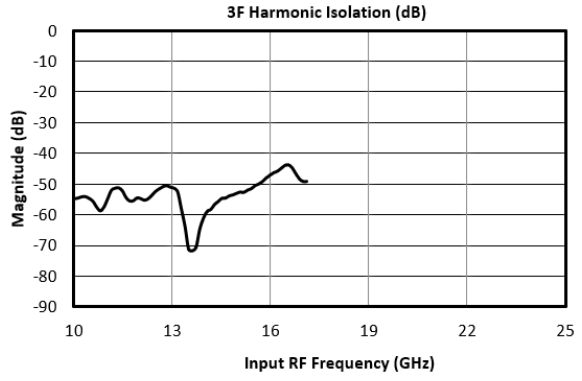
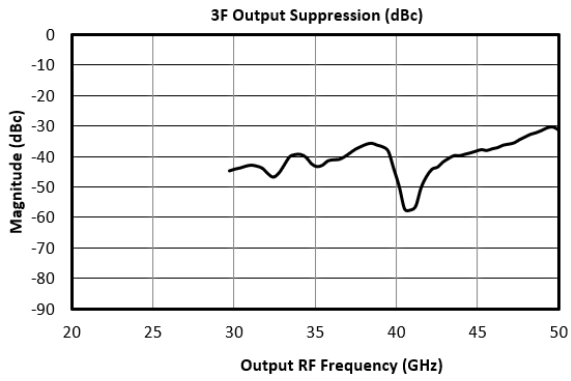

## 4. Mechanical Data

### 4.1 SM Package Outline Drawing

Pin #	Connection
1	N/C
2	Input
3	N/C
4	N/C
5	N/C
6	N/C
7	N/C
8	N/C
9	N/C
10	N/C
11	Output
12	N/C
13	N/C
14	N/C
15	N/C
16	N/C

All Dimensions are Typical

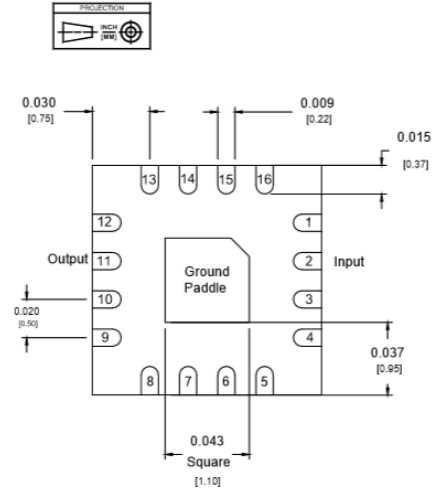
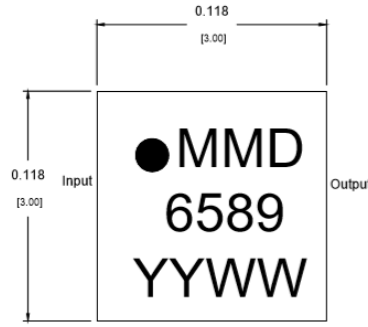

Notes (unless otherwise specified):

- Substrate material is LCP
- I/O Leads and Die Paddle is (from base to finish):  
Ni: 0.5um MIN  
Pd: 0.02um MIN  
Au: 0.05um MAX
- All unconnected pins should be connected to PCB RF ground.

### 4.2 SM Package Footprint

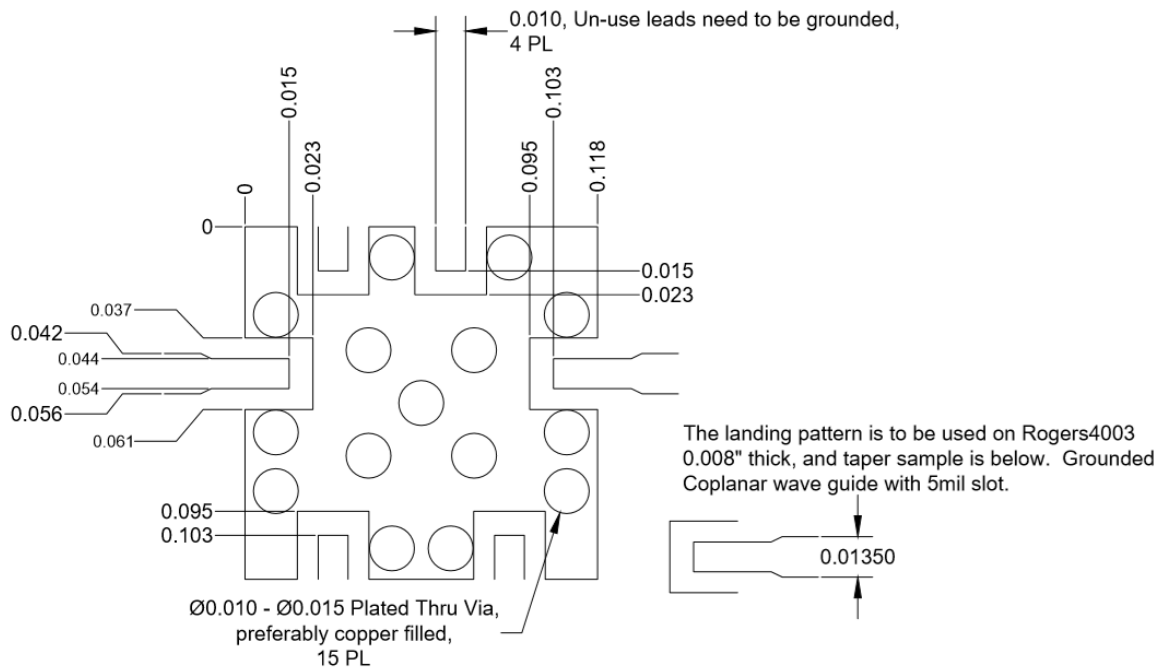

QFN-Package Surface-Mount Landing Pattern

[Click here for a DXF of the above layout.](#)

[Click here for leaded solder reflow.](#) [Click here for lead-free solder reflow](#)



### 4.3 EVAL Package Outline Drawing

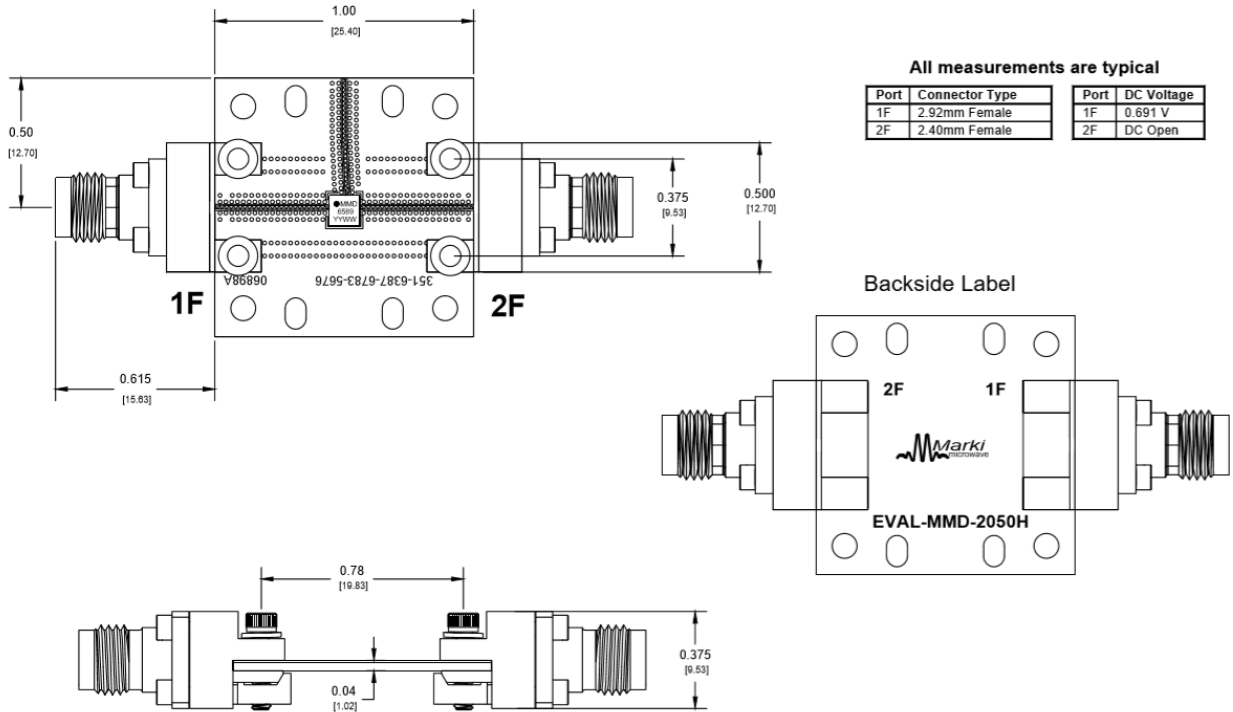

Marki Microwave reserves the right to make changes to the product(s) or information contained herein without notice.

Marki Microwave makes no warranty, representation, or guarantee regarding the suitability of its products for any particular purpose, nor does Marki Microwave assume any liability whatsoever arising out of the use or application of any product.