

GaAs MMIC Millimeter Wave Doubler

MMD-20100H

1. Device Overview

1.1 General Description

MMD-20100H is a MMIC millimeter wave 2x multiplier fabricated with GaAs Schottky diodes. MMD-20100H operates over a 10 to 50 GHz input frequency range or a doubled output frequency range of 20 to 100 GHz. MMD-20100H is available as a connectorized coaxial module using 1.0 mm connectors on the output. Wire bondable die are also available.



Die



Module

1.2 Features

- Low input power requirement
- Low loss die and package
- Up to 100GHz 2nd harmonic output tone
- Coax connector module

1.3 Applications

- mmWave frequency synthesis
- LO signal chain for mmWave mixers

1.4 Functional Block Diagram

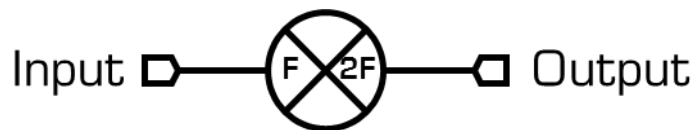

1.5 Part Ordering Options¹

| Part Number | Description | Package | Green Status | Product Lifecycle | Export Classification |
|--------------|--|---------|--------------|-------------------|-----------------------|
| MMD-20100HCH | Wire bondable die | CH | RoHS | Active | 3A001.b.7.b.1 |
| MMD-20100HM | Connectorized module; 1.0 mm connector output ² | M | | Active | 3A001.b.7.b.1 |

¹ Refer to our [website](#) for a list of definitions for terminology presented in this table.

² Default configurations has 1.0 mm female connector on the output. Consult factory for other connector options.

Table of Contents

| | | | |
|--|---|--|----|
| 1. Device Overview | 1 | 3.3 Recommended Operating Conditions . | 4 |
| 1.1 General Description..... | 1 | 3.4 Sequencing Requirements | 4 |
| 1.2 Features | 1 | 3.5 Electrical Specifications | 5 |
| 1.3 Applications | 1 | 3.6 Typical Performance Plots | 6 |
| 1.4 Functional Block Diagram | 1 | 4. Die Mounting Recommendations | 8 |
| 1.5 Part Ordering Options..... | 1 | 4.1 Mounting and Bonding | |
| 2. Port Configurations and Functions | 3 | Recommendations | 8 |
| 2.1 Port Diagram | 3 | 4.2 Handling Precautions | 8 |
| 2.2 Port Functions | 3 | 4.3 Bonding Diagram | 9 |
| 3. Specifications | 4 | 5. Mechanical Data | 10 |
| 3.1 Absolute Maximum Ratings..... | 4 | 5.1 CH Package Outline Drawing | 10 |
| 3.2 Package Information | 4 | 5.2 M Package Outline Drawing | 10 |

Revision History

| Revision Code | Revision Date | Comment |
|---------------|---------------|---------------------------|
| - | October 2020 | Initial Datasheet Release |

2. Port Configurations and Functions

2.1 Port Diagram

A top-down view of the MMD-20100H's CH package outline drawing is shown below. The MMD-20100H should only be used in the forward direction, with the input and output ports given in Port Functions.

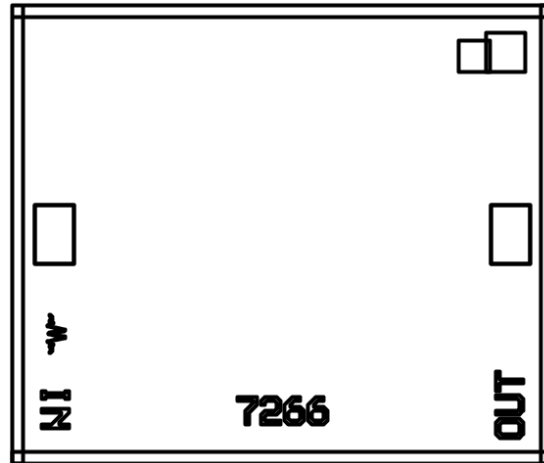

2.2 Port Functions

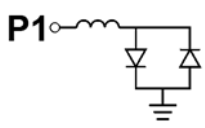
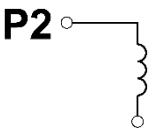
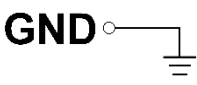
| Port | Function | Description | Equivalent Circuit for Package |
|--------|----------|--|---|
| Port 1 | Input | Port 1 is DC coupled to the diodes for the CH and M packages. Blocking capacitor is optional. |  |
| Port 2 | Output | Port 2 is DC open for the CH and M package. |  |
| GND | Ground | CH package ground path is provided through the substrate and ground bond pads. M package ground provided through metal housing and outer coax conductor. |  |

3. Specifications

3.1 Absolute Maximum Ratings

The Absolute Maximum Ratings indicate limits beyond which damage may occur to the device. If these limits are exceeded, the device may be inoperable or have a reduced lifetime.

| Parameter | Maximum Rating | Units |
|-----------------------------|----------------|-------|
| Port 1 DC Current | 25 | mA |
| Port 2 DC Current | NA | mA |
| Power Handling, at any Port | +23 | dBm |
| Operating Temperature | -55 to +100 | °C |
| Storage Temperature | -65 to +125 | °C |

3.2 Package Information

| Parameter | Details | Rating |
|-----------|--|--------|
| ESD | Human Body Model (HBM), per MIL-STD-750, Method 1020 | 1A |
| Weight | U Package | 15 g |

3.3 Recommended Operating Conditions

The Recommended Operating Conditions indicate the limits, inside which the device should be operated, to guarantee the performance given in Electrical Specifications. Operating outside these limits may not necessarily cause damage to the device, but the performance may degrade outside the limits of the electrical specifications. For limits, above which damage may occur, see Absolute Maximum Ratings.

| | Min | Nominal | Max | Units |
|--------------------------------------|-----|---------|------|-------|
| T _A , Ambient Temperature | -55 | +25 | +100 | °C |
| Input Power | | +10 | +15 | dBm |

3.4 Sequencing Requirements

There is no requirement to apply power to the ports in a specific order. However, it is recommended to provide a 50Ω termination to each port before applying power. This is a passive diode doubler that requires no DC bias.

3.5 Electrical Specifications

The electrical specifications apply at $T_A=+25^{\circ}\text{C}$ in a 50Ω system. Typical data shown is for the connectorized M package doubler used in the forward direction with a nominal +10 dBm sine wave input.

Min and Max limits apply only to our connectorized units and are guaranteed at $T_A=+25^{\circ}\text{C}$. RF testing of our die is performed on a sample basis to verify conformance to datasheet guaranteed specifications.

| Parameter | Test Conditions | Min | Typical | Max | Units |
|--|---|-----|---------|-----|-------|
| Input (Port 1) Frequency Range | | 10 | | 50 | GHz |
| Output (Port 2) Frequency Range ³ | | 20 | | 100 | |
| Input Power | | | +10 | +15 | dBm |
| 2F Output Power | Input = 10 – 12.5 GHz Output = 20 - 25 GHz | | -3 | | dBm |
| | Input = 12.5 - 35 GHz Output = 25 - 70 GHz | -3 | 0 | | |
| | Input = 35 - 45 GHz Output = 70 - 90 GHz | | -3 | | |
| | Input = 45-50 GHz Output = 90 - 100 GHz | | -6 | | |
| 2F Conversion Loss (CL) | Input = 10 – 12.5 GHz Output = 20 - 25 GHz | | 13 | | dB |
| | Input = 12.5 - 35 GHz Output = 25 - 70 GHz | | 10 | 13 | |
| | Input = 35 - 45 GHz Output = 70 - 90 GHz | | 13 | | |
| | Input = 45-50 GHz Output = 90 - 100 GHz | | 16 | | |
| Suppression ^{4,5} | 1F Input = 10 – 50 GHz Output = 10 – 50 GHz | | 24.5 | | dBc |
| | 3F Input = 10 – 33.3 GHz Output = 30 – 100 GHz | | 33 | | |
| | 4F Input = 10 – 25 GHz Output = 40 – 100 GHz | | 14 | | |
| Isolation ⁶ | 1F Input = 10 – 50 GHz Output = 10 – 50 GHz | | 36 | | dB |
| | 3F Input = 10 – 33.3 GHz Output = 30 – 100 GHz | | 44 | | |
| | 4F Input = 10 – 25 GHz Output = 40 – 100 GHz | | 25.5 | | |

³ Output return loss measured with a fixed frequency large signal 17.2 GHz input.

⁴ Suppressions and isolations measured with an input source with >60dBc (relative to fundamental input) harmonic suppression

⁵ Suppression is defined as the harmonic power relative to the 2F doubled output power.

⁶ Isolation is defined as the harmonic power relative to the 1F fundamental input power.

3.6 Typical Performance Plots

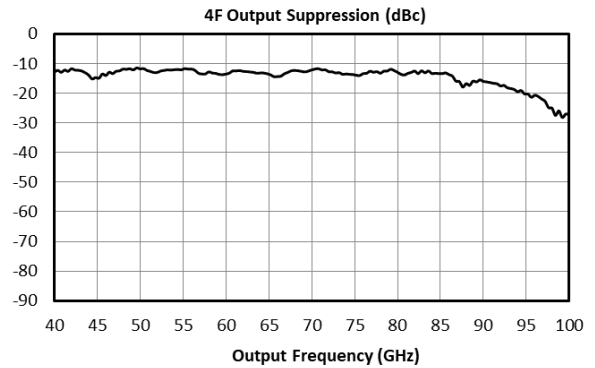
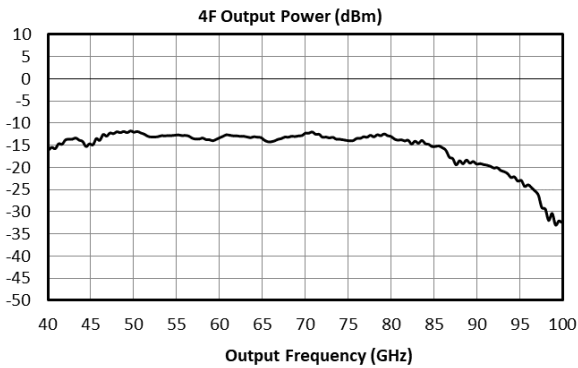
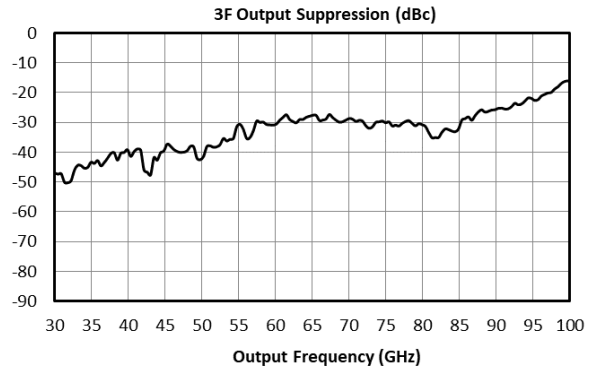
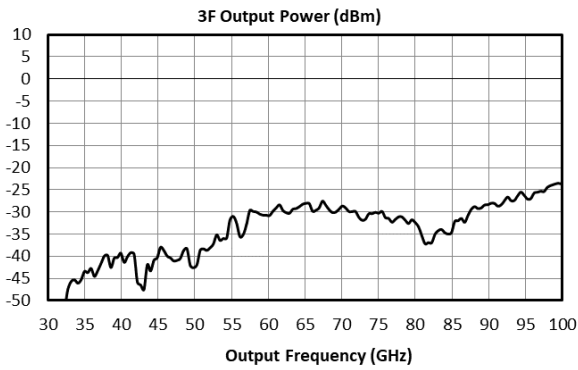
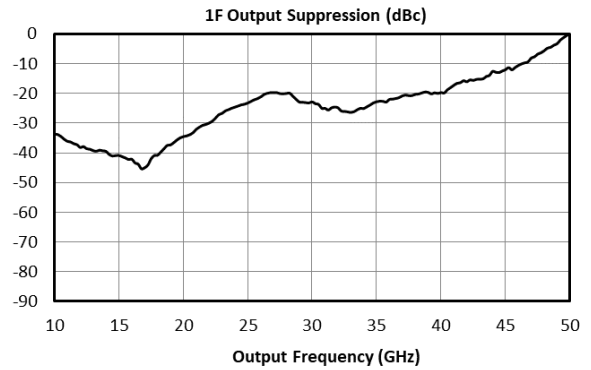
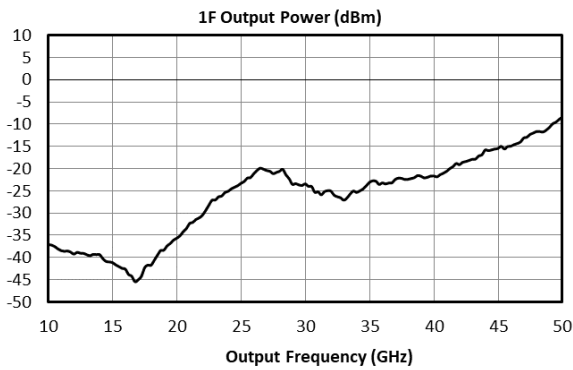
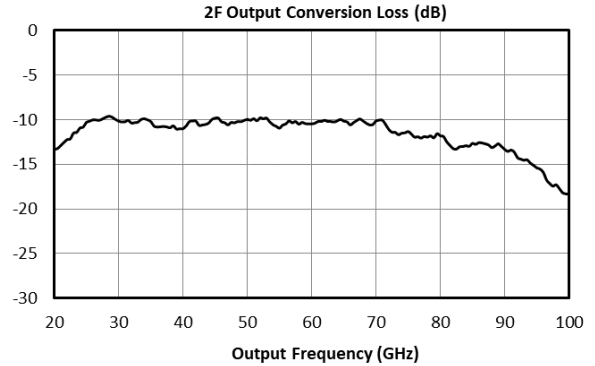
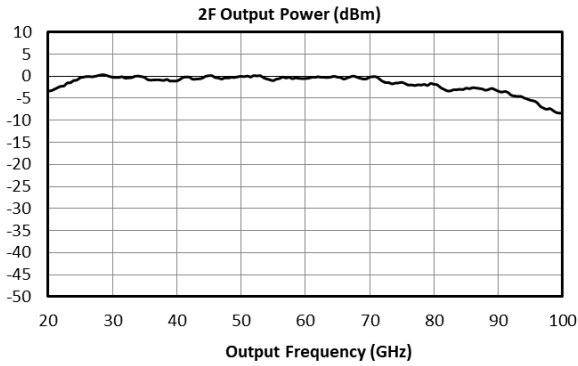

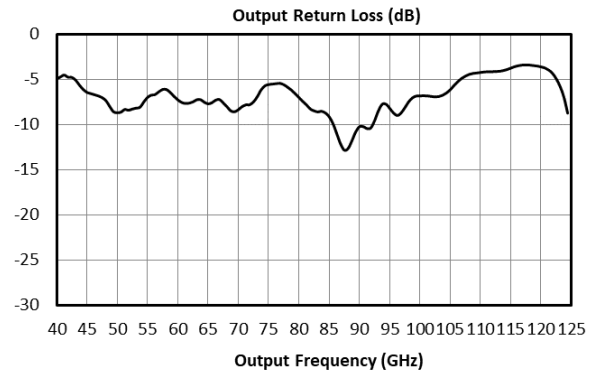
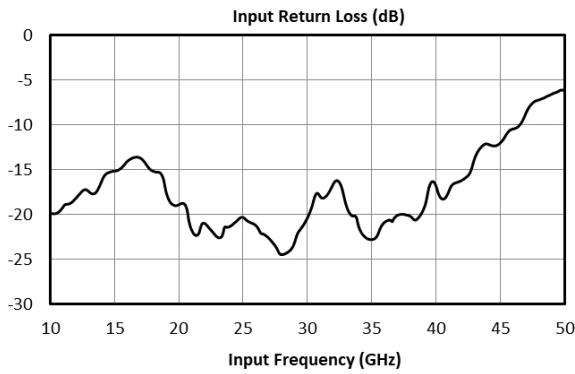
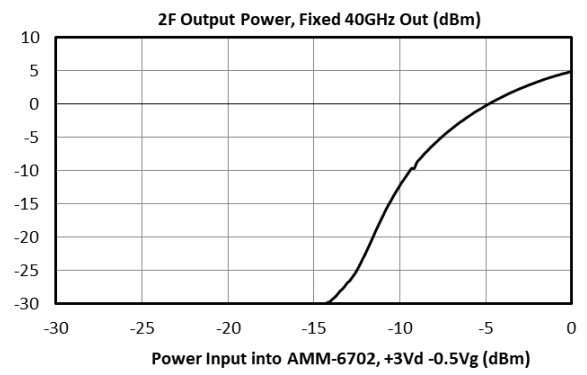
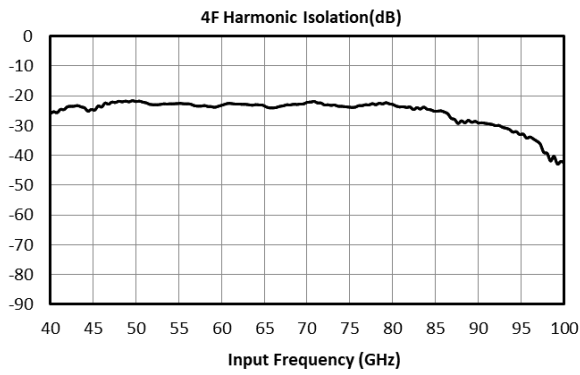
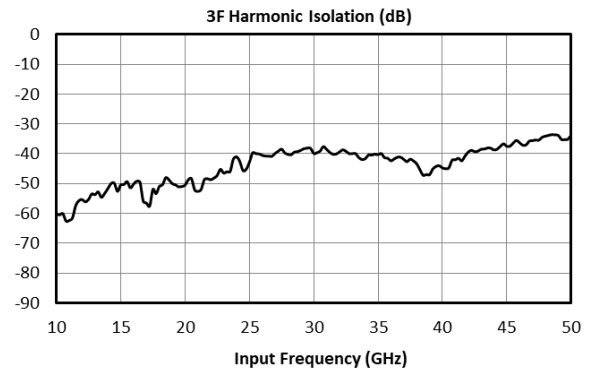
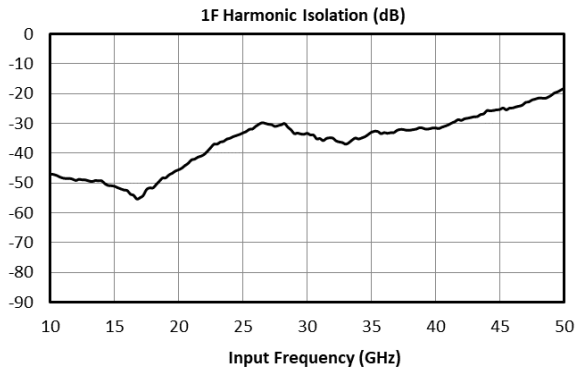

4. Die Mounting Recommendations

4.1 Mounting and Bonding Recommendations

Marki MMICs should be attached directly to a ground plane with conductive epoxy. The ground plane electrical impedance should be as low as practically possible. This will prevent resonances and permit the best possible electrical performance. Datasheet performance is only guaranteed in an environment with a low electrical impedance ground.

Mounting - To epoxy the chip, apply a minimum amount of conductive epoxy to the mounting surface so that a thin epoxy fillet is observed around the perimeter of the chip. Cure epoxy according to manufacturer instructions.

Wire Bonding - Ball or wedge bond with 0.025 mm (1 mil) diameter pure gold wire. Thermosonic wirebonding with a nominal stage temperature of 150 °C and a ball bonding force of 40 to 50 grams or wedge bonding force of 18 to 22 grams is recommended. Use the minimum level of ultrasonic energy to achieve reliable wirebonds. Wirebonds should be started on the chip and terminated on the package or substrate. All bonds should be as short as possible <0.31 mm (12 mils).

Circuit Considerations – 50 Ω transmission lines should be used for all high frequency connections in and out of the chip. Wirebonds should be kept as short as possible, with multiple wirebonds recommended for higher frequency connections to reduce parasitic inductance.

4.2 Handling Precautions

General Handling

Chips should be handled with care using tweezers or a vacuum collet. Users should take precautions to protect chips from direct human contact that can deposit contaminants, like perspiration and skin oils on any of the chip's surfaces.

Static Sensitivity

GaAs MMIC devices are sensitive to ESD and should be handled, assembled, tested, and transported only in static protected environments.

Cleaning and Storage: Do not attempt to clean the chip with a liquid cleaning system or expose the bare chips to liquid. Once the ESD sensitive bags the chips are stored in are opened, chips should be stored in a dry nitrogen atmosphere.

4.3 Bonding Diagram

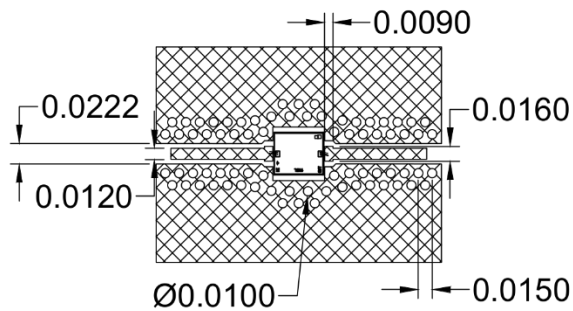

Notes: (Unless otherwise specified)

1. Units in inch
2. Front to back registration to be .002 max.
3. Shaded areas in this drawing are metalized.
4. Substrate is Rogers 5880, 0.005 in thick, $\frac{1}{2}$ oz Cu
5. Finish: ENIG, 100 μ -inches of Gold type III Grade A Soft Gold for Wire Bonding over 100-200 μ -inches solderable Nickel.

[Click here for a DWG of the above layout.](#)

Bonding interface geometries are completely dependent on customer circuit board substrate, interface design is required. Contact factory for support.

Reference PCB design shown above can be downloaded [here](#). Reference PCB design is the same design used in the M package module.

5. Mechanical Data

5.1 CH Package Outline Drawing

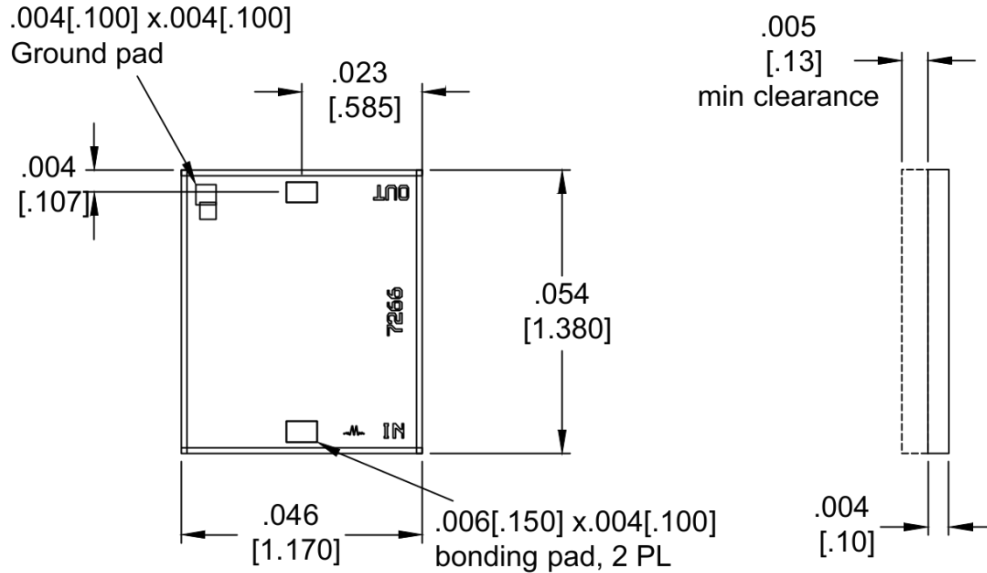

1. CH Substrate material is 0.004 in thick GaAs.
2. I/O trace finish is 4.2 microns Au. Ground plane finish is 5 microns Au.

5.2 M Package Outline Drawing

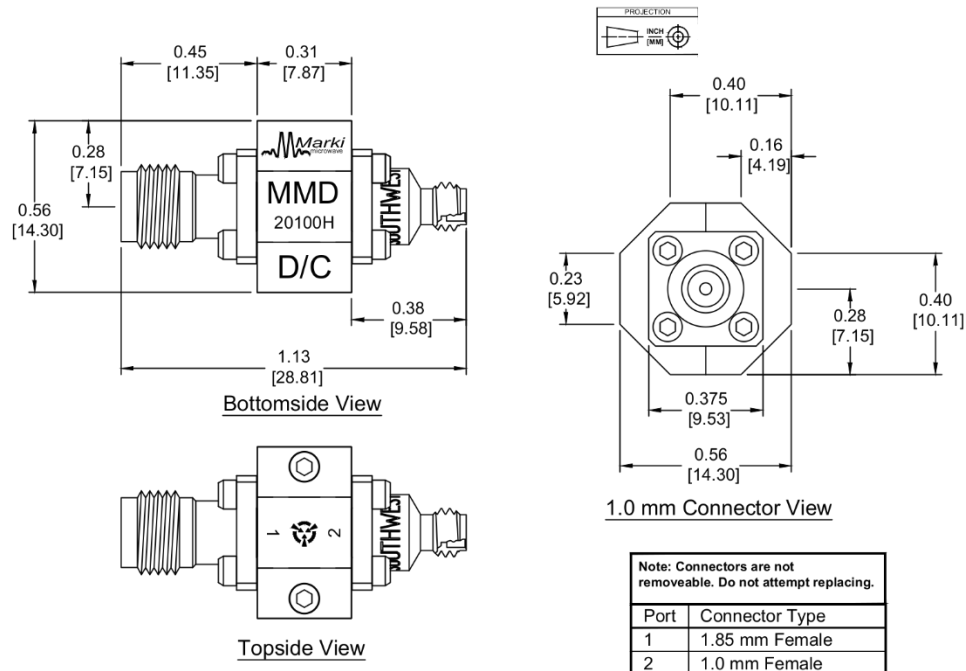

Marki Microwave reserves the right to make changes to the product(s) or information contained herein without notice.

Marki Microwave makes no warranty, representation, or guarantee regarding the suitability of its products for any particular purpose, nor does Marki Microwave assume any liability whatsoever arising out of the use or application of any product.