

GaAs MMIC Doubler

MMD-1030L

1. Device Overview

1.1 General Description

The MMD-1030L is a MMIC doubler fabricated with GaAs Schottky diodes. This part operates over a 5 to 15 GHz input frequency range or a doubled output frequency range of 10 to 30 GHz. It features excellent conversion loss, superior isolations, and harmonic suppressions across a broad bandwidth. Both the wire bondable die and connectorized units are available.



Die



Module

1.2 Features

- High Fundamental Rejection
- Low 2F Conversion Loss
- Low Input Drive

1.3 Applications

- High Frequency Synthesis
- LO Signal Chain

1.4 Functional Block Diagram

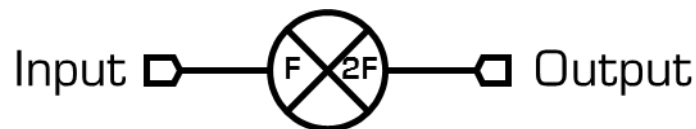

1.5 Part Ordering Options¹

Part Number	Description	Package	Green Status	Product Lifecycle	Export Classification
MMD-1030LCH	Wire bondable die	CH	RoHS	Active	EAR99
MMD-1030LS	Connectorized module; 2.92 mm connector output	S		Active	EAR99

¹ Refer to our [website](#) for a list of definitions for terminology presented in this table.

Table of Contents

1. Device Overview	1	3.4 Sequencing Requirements	4
1.1 General Description.....	1	3.5 Electrical Specifications	5
1.2 Features	1	3.6 Typical Performance Plots	6
1.3 Applications	1	4. Die Mounting Recommendations	7
1.4 Functional Block Diagram	1	4.1 Mounting and Bonding	
1.5 Part Ordering Options.....	1	Recommendations	7
2. Port Configurations and Functions	3	4.2 Handling Precautions	7
2.1 Port Diagram	3	4.3 Bonding Diagram	8
2.2 Port Functions	3	5. Mechanical Data	9
3. Specifications	4	5.1 CH Package Outline Drawing	9
3.1 Absolute Maximum Ratings.....	4	5.3 S package Outline Drawing	9
3.2 Package Information	4		
3.3 Recommended Operating Conditions .	4		

Revision History

Revision Code	Revision Date	Comment
-	December 2022	Datasheet Initial Release

2. Port Configurations and Functions

2.1 Port Diagram

A top-down view of the MMD-1030L's CH package outline drawing is shown below. The MMD-1030L should only be used in the forward direction, with the input and output ports given in Port Functions.

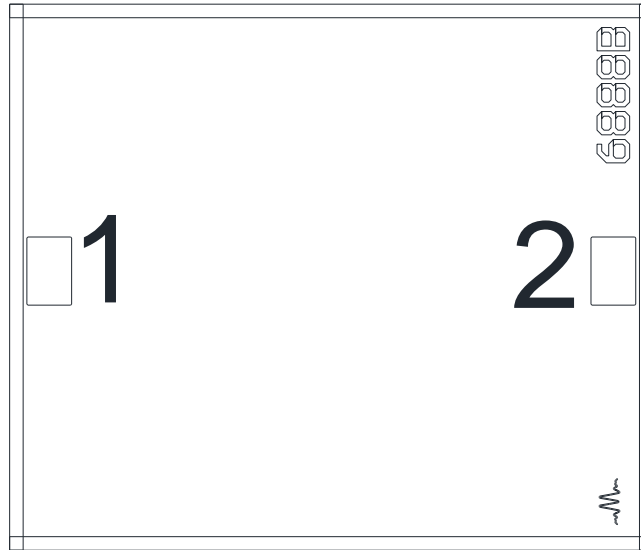

2.2 Port Functions

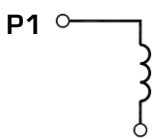
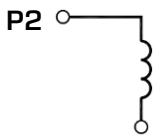
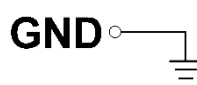
Port	Function	Description	Equivalent Circuit for Package
Port 1	1F Input	Port 1 is DC open and AC matched to 50 Ohms from 5 to 15 GHz for the CH & S packages.	
Port 2	2F Output	Port 2 is DC open and AC matched to 50 Ohms from 10 to 30 GHz for the CH & S packages.	
GND	Ground	CH package ground path is provided through the substrate and ground bond pads. S package ground provided through metal housing and outer coax conductor.	

3. Specifications

3.1 Absolute Maximum Ratings

The Absolute Maximum Ratings indicate limits beyond which damage may occur to the device. All Absolute Maximum Ratings are individual and should not be met in parallel. If these limits are exceeded, the device may be inoperable or have a reduced lifetime.

Parameter	Maximum Rating	Units
Port 1 DC Current	N/A	mA
Port 2 DC Current	N/A	mA
Power Handling, at any Port	+25 ²	dBm
Operating Temperature	-55 to +100	°C
Storage Temperature	-65 to +125	°C

3.2 Package Information

Parameter	Details	Rating
Weight	S Package	10.4 g

3.3 Recommended Operating Conditions

The Recommended Operating Conditions indicate the limits, inside which the device should be operated, to guarantee the performance given in Electrical Specifications. Operating outside these limits may not necessarily cause damage to the device, but the performance may degrade outside the limits of the electrical specifications. For limits, above which damage may occur, see Absolute Maximum Ratings.

	Min	Nominal	Max	Units
Operating Temperature	-55	+25	+100	°C
Input Power	+5	+7	+15	dBm

3.4 Sequencing Requirements

There is no requirement to apply power to the ports in a specific order. However, it is recommended to provide a 50Ω termination to each port before applying power. This is a passive diode doubler that requires no DC bias.

² +25 dBm at +25°C, derated linearly to +20 dBm at +100°C

3.5 Electrical Specifications

The electrical specifications apply at $T_A=+25^{\circ}\text{C}$ in a 50Ω system. Typical data shown is for the connectorized S package doubler used in the forward direction with a +7 dBm sine wave input.

Min and Max limits apply only to our connectorized units and are guaranteed at $T_A=+25^{\circ}\text{C}$. RF testing of our die is performed on a sample basis to verify conformance to datasheet guaranteed specifications.

Parameter	Test Conditions	Min	Typical	Max	Units
Input (Port 1) Frequency Range		5		15	GHz
Output (Port 2) Frequency Range		10		30	
Input Power		+5	+7	+15	dBm
2F Conversion Loss (CL)	Input = 5 – 15 GHz Output = 10 - 30 GHz		12.5	14	dB
Suppression ^{3,4}	1F Input = 5 – 15 GHz Output = 10 - 30 GHz		38		dBc
	3F Input = 5 – 10 GHz Output = 15 - 30 GHz		46		
	4F Input = 5 – 7.5 GHz Output = 20 - 30 GHz		15		
Isolations ⁵	1F Input = 5 - 15 GHz Output = 10 - 30 GHz		50		dB
	3F Input = 5 – 10 GHz Output = 15 - 30 GHz		58		
	4F Input = 5 – 7.5 GHz Output = 20 - 30 GHz		27		

³ Suppressions and isolations measured with an input source with >60dBc (relative to fundamental input) harmonic suppression

⁴ Suppression is defined as the harmonic power relative to the 2F doubled output power

⁵ Isolation is defined as the harmonic power relative to the 1F fundamental input power.

3.6 Typical Performance Plots

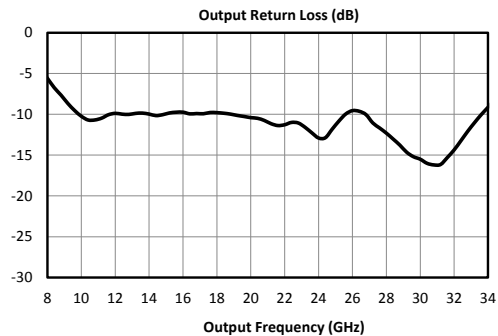
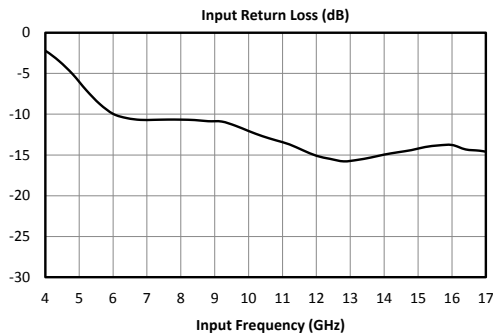
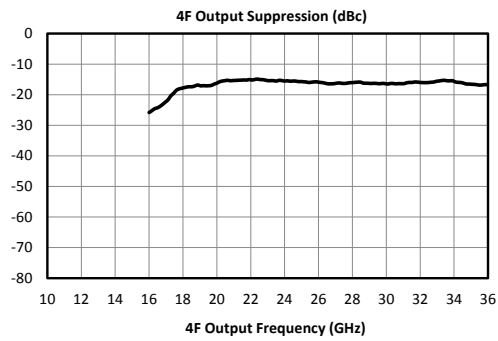
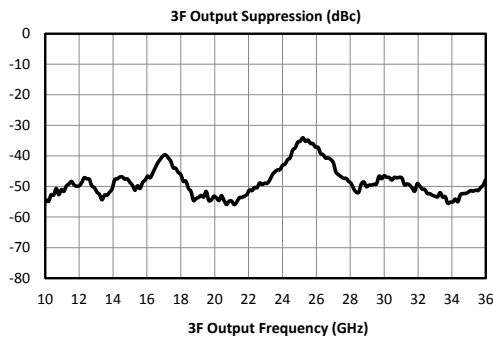
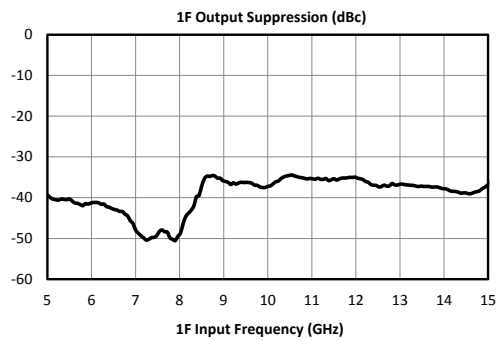
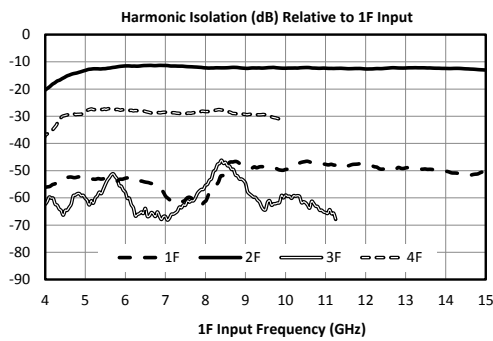
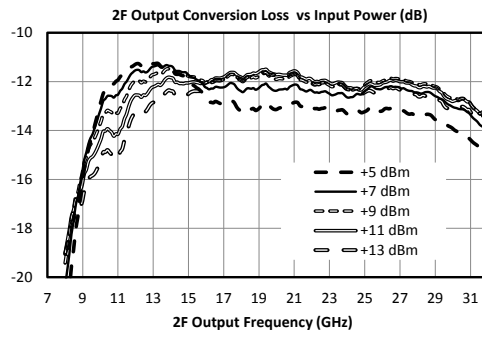
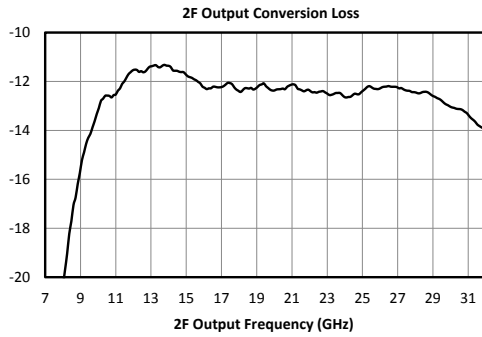

4. Die Mounting Recommendations

4.1 Mounting and Bonding Recommendations

Marki MMICs should be attached directly to a ground plane with conductive epoxy. The ground plane electrical impedance should be as low as practically possible. This will prevent resonances and permit the best possible electrical performance. Datasheet performance is only guaranteed in an environment with a low electrical impedance ground.

Mounting - To epoxy the chip, apply a minimum amount of conductive epoxy to the mounting surface so that a thin epoxy fillet is observed around the perimeter of the chip. Cure epoxy according to manufacturer instructions.

Wire Bonding - Ball or wedge bond with 0.025 mm (1 mil) diameter pure gold wire. Thermosonic wirebonding with a nominal stage temperature of 150 °C and a ball bonding force of 40 to 50 grams or wedge bonding force of 18 to 22 grams is recommended. Use the minimum level of ultrasonic energy to achieve reliable wirebonds. Wirebonds should be started on the chip and terminated on the package or substrate. All bonds should be as short as possible <0.31 mm (12 mils).

Circuit Considerations – 50 Ω transmission lines should be used for all high frequency connections in and out of the chip. Wirebonds should be kept as short as possible, with multiple wirebonds recommended for higher frequency connections to reduce parasitic inductance. In circumstances where the chip more than .001” thinner than the substrate, a heat spreading spacer tab is optional to further reduce bondwire length and parasitic inductance.

4.2 Handling Precautions

General Handling

Chips should be handled with care using tweezers or a vacuum collet. Users should take precautions to protect chips from direct human contact that can deposit contaminants, like perspiration and skin oils on any of the chip's surfaces.

Static Sensitivity

GaAs MMIC devices are sensitive to ESD and should be handled, assembled, tested, and transported only in static protected environments.

Cleaning and Storage: Do not attempt to clean the chip with a liquid cleaning system or expose the bare chips to liquid. Once the ESD sensitive bags the chips are stored in are opened, chips should be stored in a dry nitrogen atmosphere.

4.3 Bonding Diagram

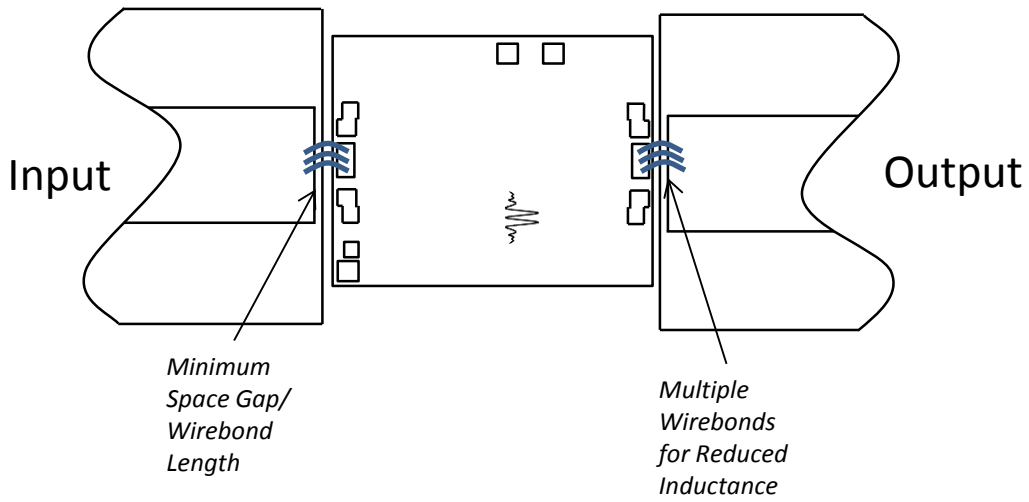

5. Mechanical Data

5.1 CH Package Outline Drawing

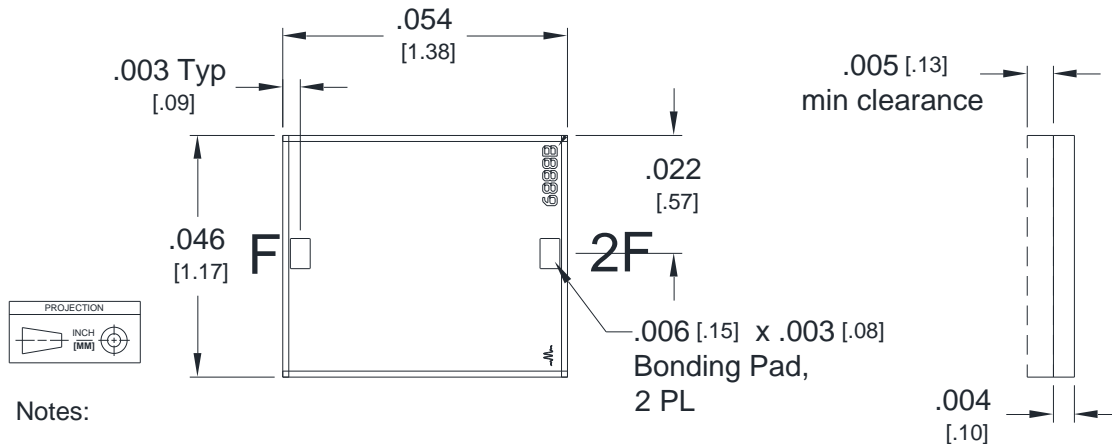

Notes:

1. CH substrate is .004 in Thick GaAs.
2. I/O traces finish is 4.2 microns Au. Ground plane finish is 5 microns Au.
3. Tolerance for X, Y dimensions is ± 0.002 in.
Tolerance for Z dimension is ± 0.0005 in.
Tolerance for pad location is ± 0.0001 in.

5.3 S package Outline Drawing

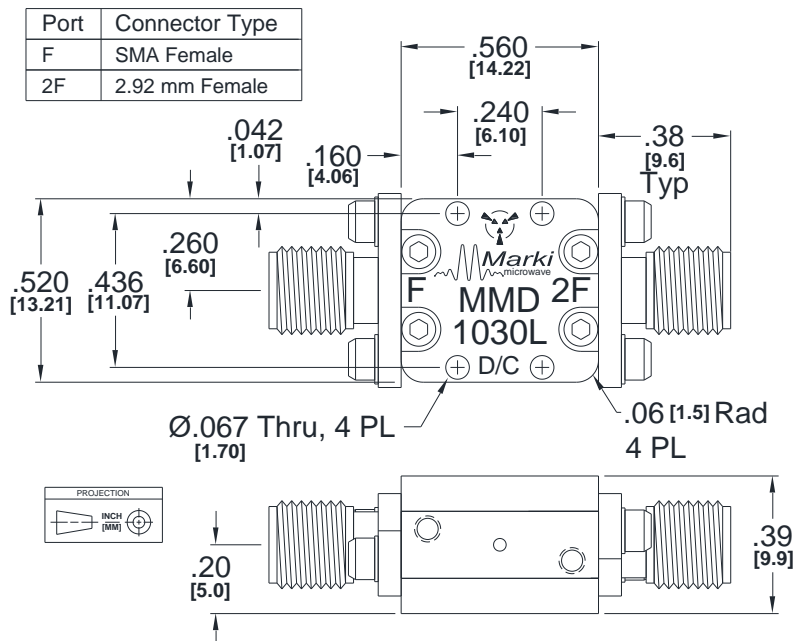

Marki Microwave reserves the right to make changes to the product(s) or information contained herein without notice.

Marki Microwave makes no warranty, representation, or guarantee regarding the suitability of its products for any particular purpose, nor does Marki Microwave assume any liability whatsoever arising out of the use or application of any product.