

GaAs MMIC DOUBLER

MMD-1030H

The MMD-1030H is a passive double balanced MMIC doubler covering 10 to 30 GHz on the output. It features excellent conversion loss, superior isolations and harmonic suppressions across a broad bandwidth, in a highly miniaturized form factor. Accurate, nonlinear simulation models are available for Microwave Office® through the Marki Microwave PDK. The MMD-1030H is available as a wire bondable chip or a connectorized package. The MMD-1030H is a superior alternative to Marki Microwave carrier and packaged doublers.

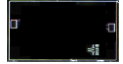

- Compact Chip Style Package (0.058" x 0.032"x0.004")
- CAD Optimized for Superior Suppressions and Efficiency
- Broadband Performance
- Excellent Unit-to-Unit Repeatability
- Fully nonlinear software models available with Marki PDK for Microwave Office®
- RoHS Compliant

Electrical Specifications - Specifications guaranteed from -55 to +100°C, measured in a 50Ω system. All bare die are 100% DC tested and 100% visual inspected. RF testing is performed on a sample basis to verify conformance to datasheet guaranteed specifications. Consult factory for more information.

Parameter	Input (GHz)	Output (GHz)	Min	Typ	Max	Diode Option Input drive level (dBm)
2F (out) Conversion Loss (dB)	5-15	10-30		12	17	
Suppressions ¹						
1F (in) Fundamental				41		
3F (out) Third Harmonic				47		
4F (out) Fourth Harmonic				17		
Isolations ¹						
1F (in) Fundamental				53		
3F (out) Third Harmonic				58		
4F (out) Fourth Harmonic				29		
1F Input Level			+10	+14	+17	H-Version

¹ Suppression is relative to doubled output power. Isolation is defined as relative to the fundamental input power.

Part Number Options

Please specify diode level and package style by adding to model number.						
Package Styles		Examples				
Connectorized ¹	S	MMD-1030HCH, MMD-1030HS				
Chip ^{2,3} (RoHS)	CH	<u>MMD-1030</u> (Model)	<u>H</u> (Diode Option)	<u>CH</u> (Package)		

¹ Connectorized package consists of chip package wire bonded to a substrate, equivalent to an evaluation board.

² Chip package connects to external circuit through wire bondable gold pads.

³ Note: For port locations and I/O designations, refer to the drawing on page 3 of this document.

GaAs MMIC DOUBLER

Page 2

MMD-1030H

Input 5 to 15 GHz
Output 10 to 30 GHz

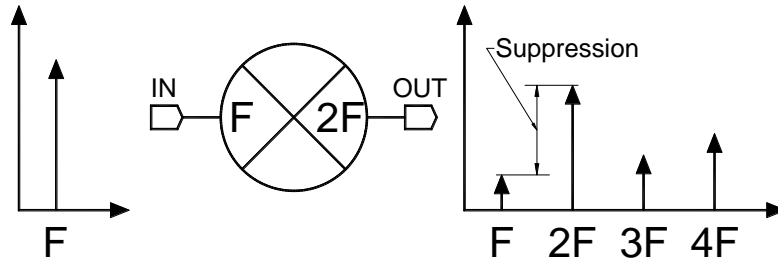

Typical Performance

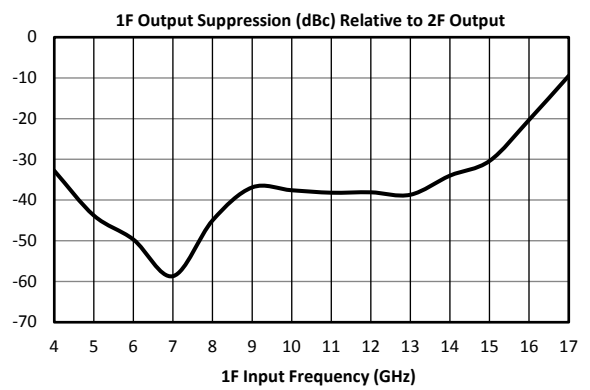
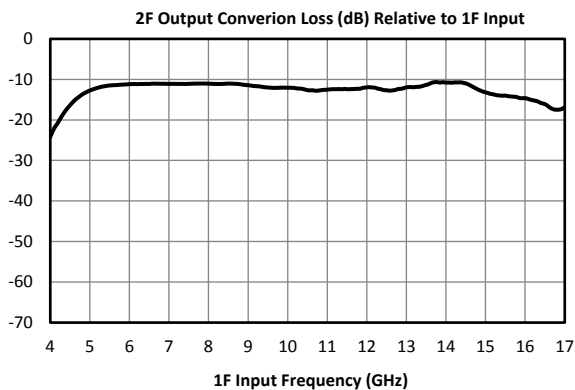
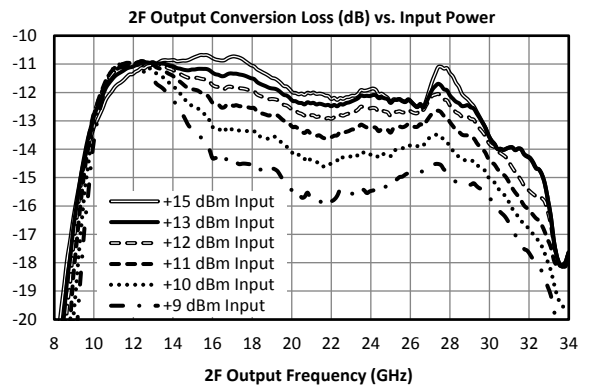
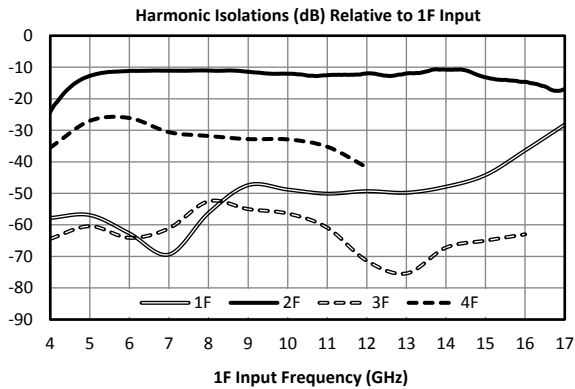

GaAs MMIC DOUBLER

Page 3

MMD-1030H

Input 5 to 15 GHz
Output 10 to 30 GHz

Typical Performance (cont.)

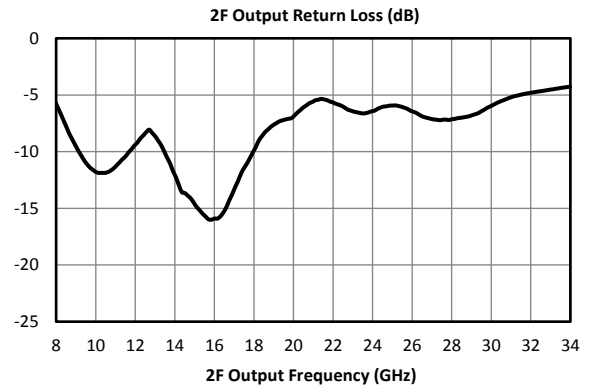
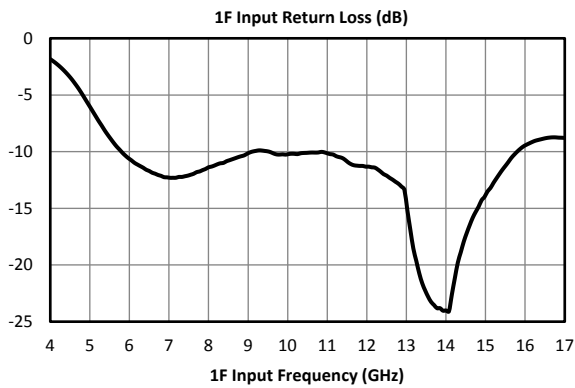
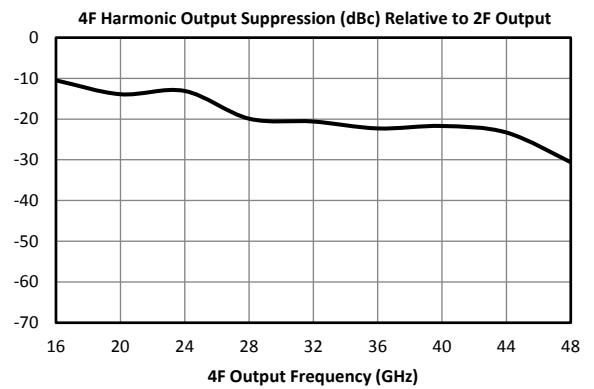
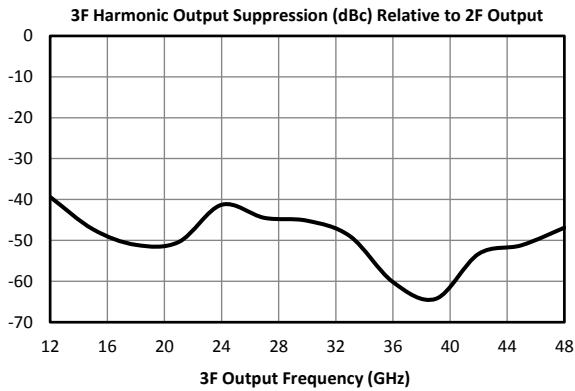

GaAs MMIC DOUBLER

Page 4

MMD-1030H

Input 5 to 15 GHz
Output 10 to 30 GHz

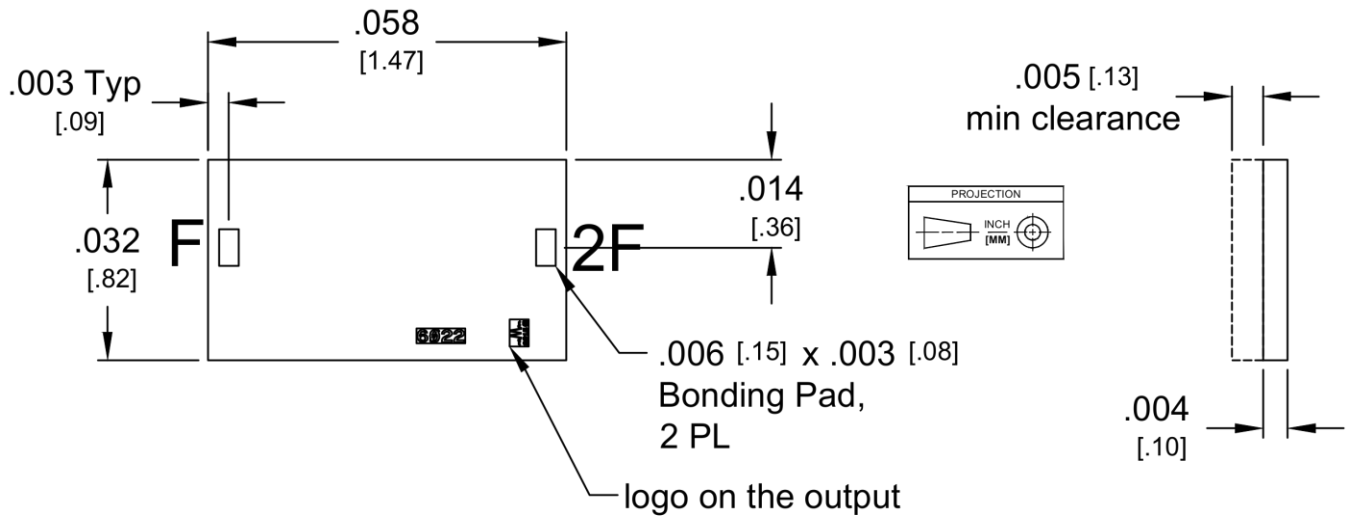

1. CH Substrate material is .004 thick GaAs.
2. I/O traces and ground plane finish are 2 microns Au.
3. Wire Bonding - Ball or wedge bond with 0.025 mm (1 mil) diameter pure gold wire. Thermosonic wirebonding with a nominal stage temperature of 150 °C and a ball bonding force of 40 to 50 grams or wedge bonding force of 18 to 22 grams is recommended. Use the minimum level of ultrasonic energy to achieve reliable wirebonds. Wirebonds should be started on the chip and terminated on the package or substrate. All bonds should be as short as possible <0.31 mm (12 mils).

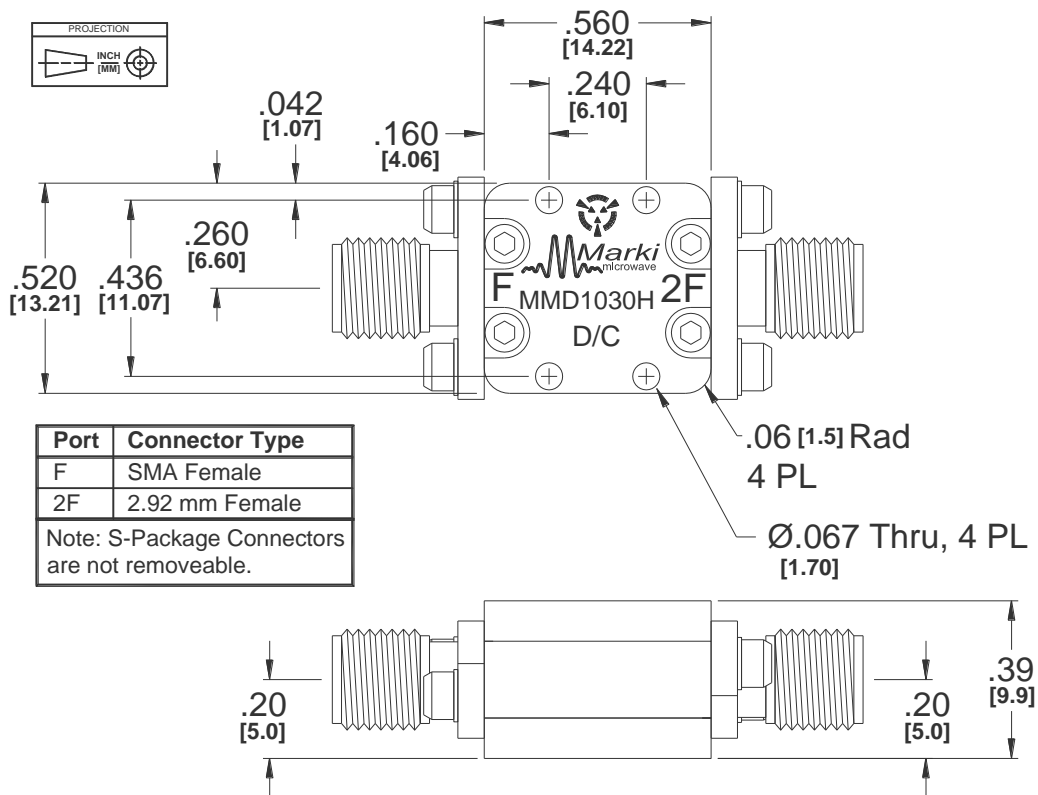

Outline Drawing – SD package

GaAs MMIC DOUBLER

Page 5

MMD-1030H

Input 5 to 15 GHz
Output 10 to 30 GHz

Mounting and Bonding Recommendations

Marki MMICs should be attached directly to a ground plane with conductive epoxy. The ground plane electrical impedance should be as low as practically possible. This will prevent resonances and permit the best possible electrical performance. Datasheet performance is only guaranteed in an environment with a low electrical impedance ground.

Mounting - To epoxy the chip, apply a minimum amount of conductive epoxy to the mounting surface so that a thin epoxy fillet is observed around the perimeter of the chip. Cure epoxy according to manufacturer instructions.

Wire Bonding - Ball or wedge bond with 0.025 mm (1 mil) diameter pure gold wire. Thermosonic wirebonding with a nominal stage temperature of 150 °C and a ball bonding force of 40 to 50 grams or wedge bonding force of 18 to 22 grams is recommended. Use the minimum level of ultrasonic energy to achieve reliable wirebonds. Wirebonds should be started on the chip and terminated on the package or substrate. All bonds should be as short as possible <0.31 mm (12 mils).

Circuit Considerations – 50 ohm transmission lines should be used for all high frequency connections in and out of the chip. Wirebonds should be kept as short as possible, with multiple wirebonds recommended for higher frequency connections to reduce parasitic inductance. In circumstances where the chip more than .001" thinner than the substrate, a heat spreading spacer tab is optional to further reduce bondwire length and parasitic inductance.

Handling Precautions

General Handling: Chips should be handled with a vacuum collet when possible, or with sharp tweezers using well trained personnel. The surface of the chip is fragile and should not be contacted if possible.

Static Sensitivity: GaAs MMIC devices are subject to static discharge, and should be handled, assembled, tested, and transported only in static protected environments.

Cleaning and Storage: Do not attempt to clean the chip with a liquid cleaning system or expose the bare chips to liquid. Once the ESD sensitive bags the chips are stored in are opened, chips should be stored in a dry nitrogen atmosphere.

Bonding Diagram

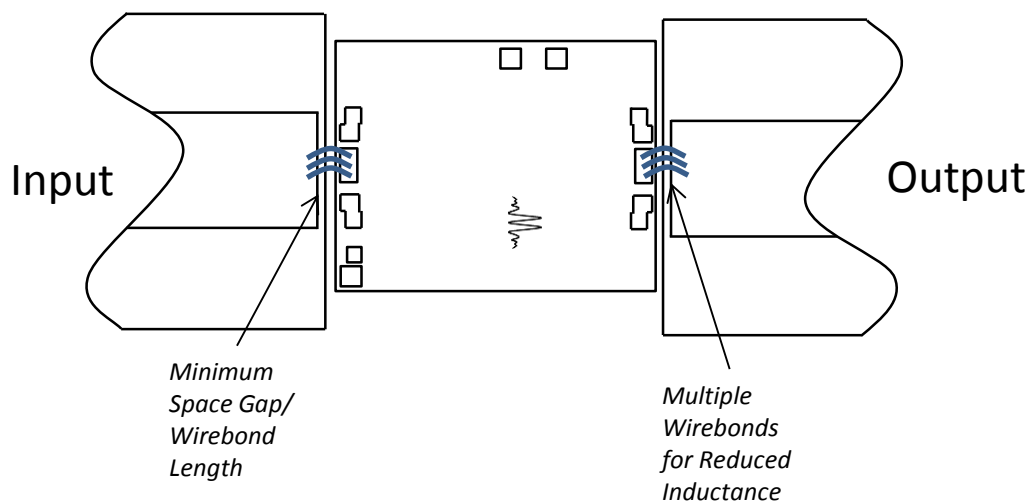

GaAs MMIC DOUBLER

Page 6

MMD-1030H

Input 5 to 15 GHz
Output 10 to 30 GHz

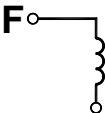
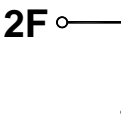
Port	Description	DC Interface Schematic
F Input	The input port is DC open and AC matched to 50 Ohms from 5 to 15 GHz. Blocking capacitor is optional.	
2F Output	The output port is DC open and AC matched to 50 Ohms from 10 to 30 GHz. Blocking capacitor is optional.	

Absolute Maximum Ratings	
Parameter	Maximum Rating
Input DC Current	N/A
Output DC Current	N/A
RF Power Handling	+25 dBm at +25°C, derated linearly to +20 dBm at +100°C
Operating Temperature	-55°C to +100°C
Storage Temperature	-65°C to +125°C

DATA SHEET NOTES:

1. Doubled Loss typically degrades less than 0.5 dB at +100°C and improves less than 0.5 dB at -55°C.
2. Unless otherwise specified, H-Diode data is taken with a +14 dBm input.
3. Specifications are subject to change without notice. Contact Marki Microwave for the most recent specifications and data sheets.
4. Catalog doubler circuits are continually improved. Configuration control requires custom model numbers and specifications.

Marki Microwave reserves the right to make changes to the product(s) or information contained herein without notice. Marki Microwave makes no warranty, representation, or guarantee regarding the suitability of its products for any particular purpose, nor does Marki Microwave assume any liability whatsoever arising out of the use or application of any product.

© Marki Microwave, Inc.

