

## GaAs MMIC Triple Balanced Mixer

Page 1

## MM2-0530HSM

The MM2-0530HSM is a passive MMIC triple balanced mixer. It features a broadband IF port that spans from 2 to 20 GHz, and has excellent spurious suppression. GaAs MMIC technology improves upon the previous generation of hand assembled, hybrid M2 triple balanced mixers with improved isolations, unit-to-unit repeatability and reliability. The MM2-0530HSM is 4x4 mm QFN packaged. Evaluation boards are available. For a list of recommended LO driver amps for all mixers and IQ mixers, see [here](#).

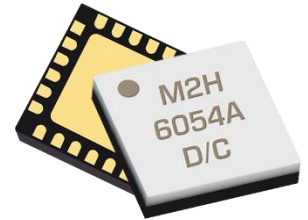

QFN

### Features

- Broadband IF Port
- Typical Input 1 dB Compression of +15 dBm
- High Input IP3 of +21 dBm
- Excellent LO to RF Isolation
- Unit-to-Unit Repeatability
- RoHS Compliant

**Electrical Specifications** - Specifications guaranteed from -55 to +100°C, measured in a 50Ω system. Specifications are shown for Configurations A (B). See page 2 for port locations.

Parameter	LO (GHz)	RF (GHz)	IF (GHz)	Min	Typ	Max	LO drive level (dBm)
Conversion Loss (dB) <sup>1</sup>	5-30	5-30	2-20		8 (9)		+20
Isolation (dB) LO-RF LO-IF RF-IF					See Plots		Config. A: + 16 to + 22 Config. B: + 16 to + 22
Input 1 dB Compression (dBm)					14 19		
Input Two-Tone Third Order Intercept Point (dBm) <sup>2</sup>					+ 21 + 28		

<sup>1</sup>Measured Conversion Loss measured at 3 GHz fixed IF

<sup>2</sup>IP3 depends on LO drive conditions, see plots for more details

### Part Number Options

Model Number	Description
MM2-0530HSM-2 <sup>1</sup>	Surface Mount, IF Port Configuration -2
EVAL-MM2-0530H	Connectorized Evaluation Fixture

<sup>1</sup>Note: For port locations and I/O designations, refer to the drawings on page 2 of this document.

# GaAs MMIC Triple Balanced Mixer

# MM2-0530HSM

Page 2

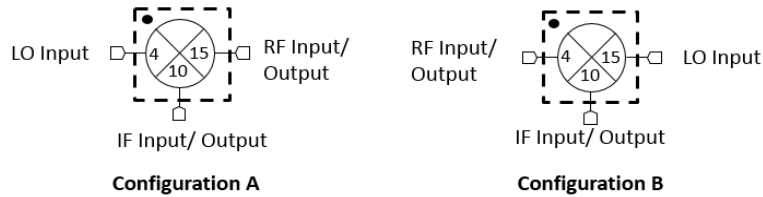

- Configuration A/B refer to the same part number (MM2-0530HSM) used in one of two different ways for optimal spurious performance. For the lowest conversion loss, use the mixer in Configuration A (pin 4 as the LO input, pin 15 as the RF input or output). If you need to use a lower LO drive, use the mixer in Configuration B (pin 4 as the RF input or output, pin 15 as the LO input). For optimal spurious suppression, experimentation or simulation is required to choose between Configuration A and B. For more information, [see here](#).

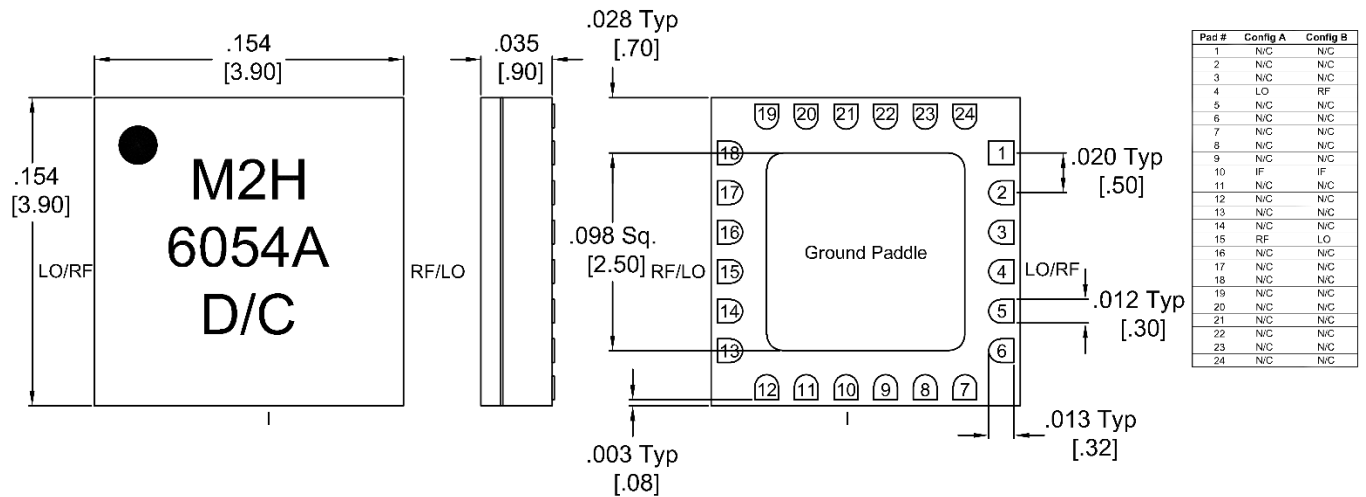

Outline Drawing – 4mm QFN package

- Substrate material is Ceramic.
- I/O leads and Die Paddle are: Ni: 8.89um MAX 1.27um MIN. Pd : 0.17um MAX 0.07um MIN. Au : 0.254um MAX 0.03um MIN
- All unconnected pads should be connected to PCB RF ground

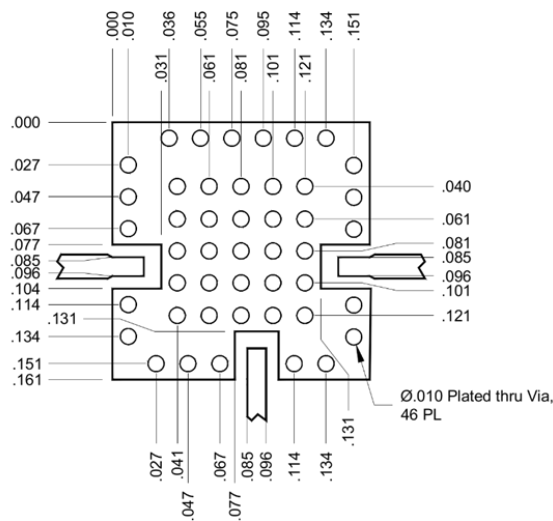

QFN-Package Surface-Mount Landing Pattern

[Click here for a DXF of the above layout.](#)  
[Click here for leaded solder reflow.](#) [Click here for lead-free solder reflow.](#)

# GaAs MMIC Triple Balanced Mixer

# MM2-0530HSM

Page 3

## Typical Performance

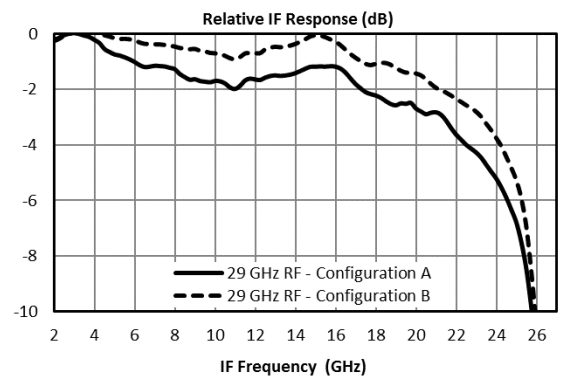
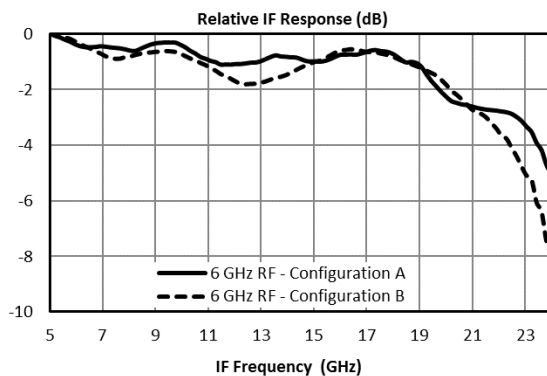
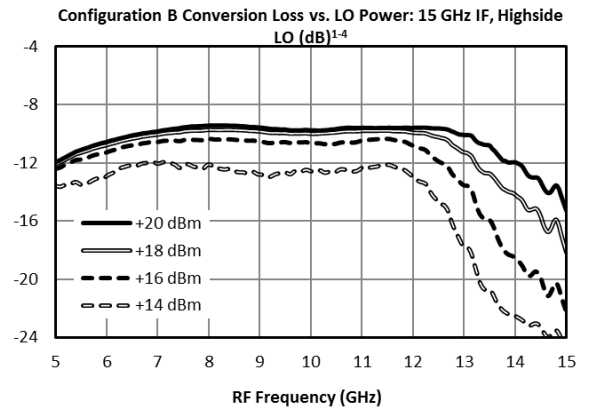
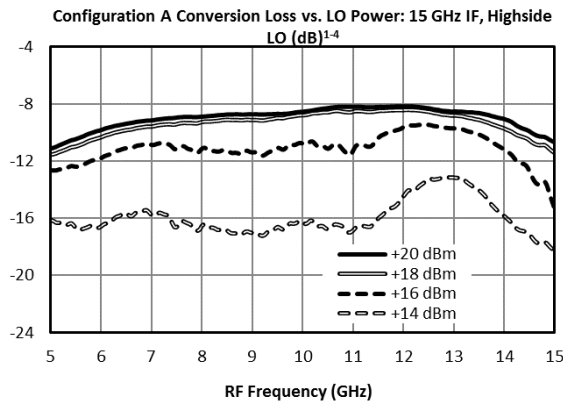
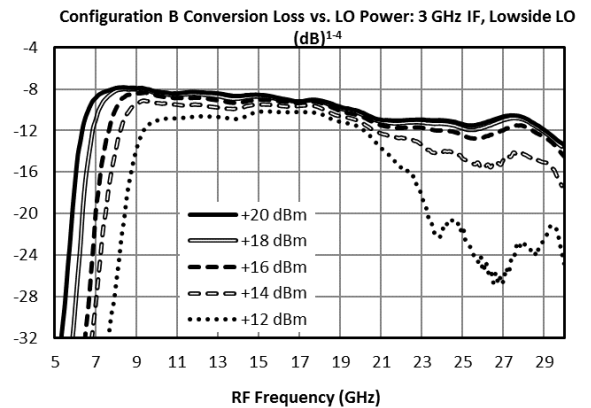
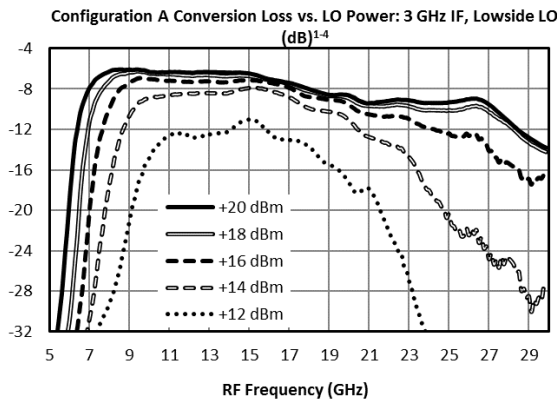
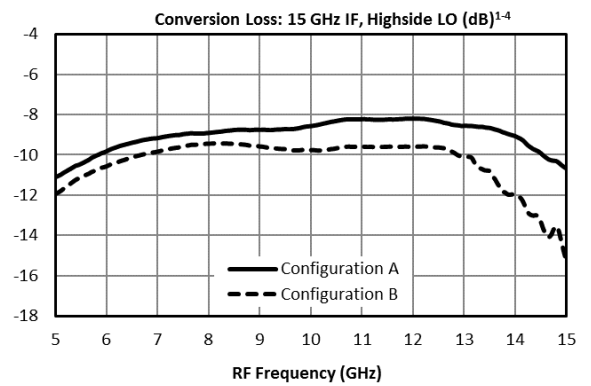
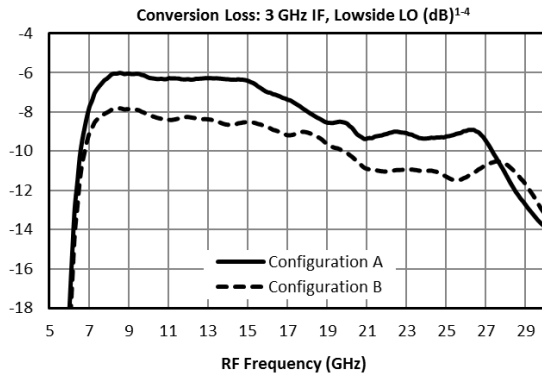

Typical Performance

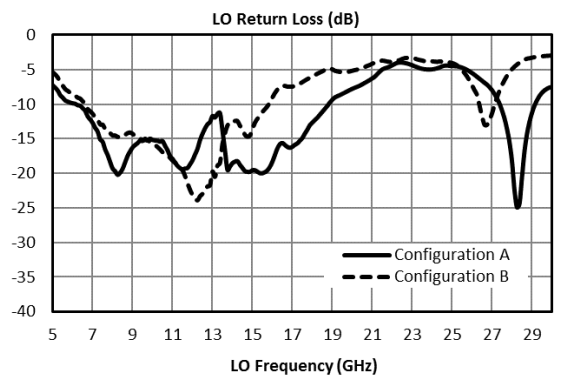
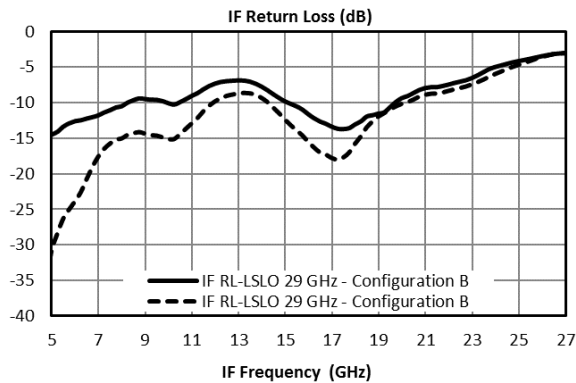
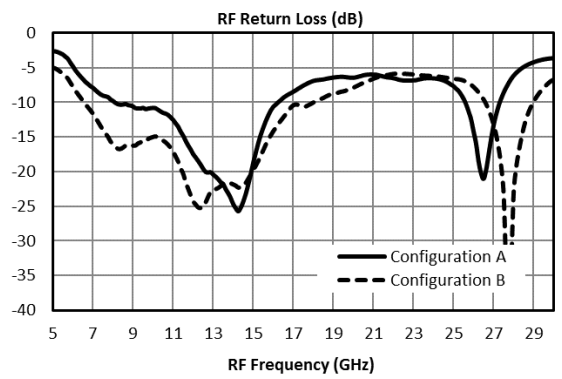
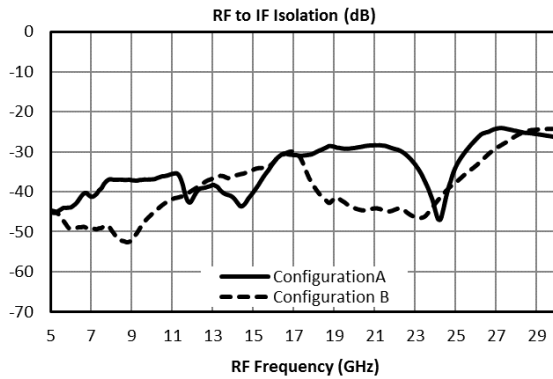
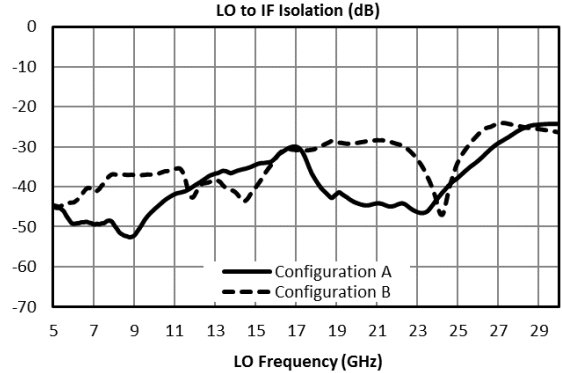
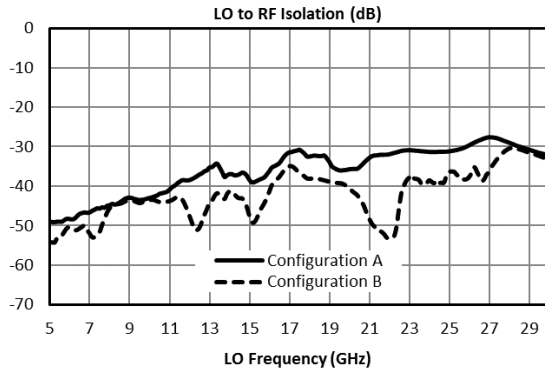

# GaAs MMIC Triple Balanced Mixer

# MM2-0530HSM

Page 5

## Typical Performance

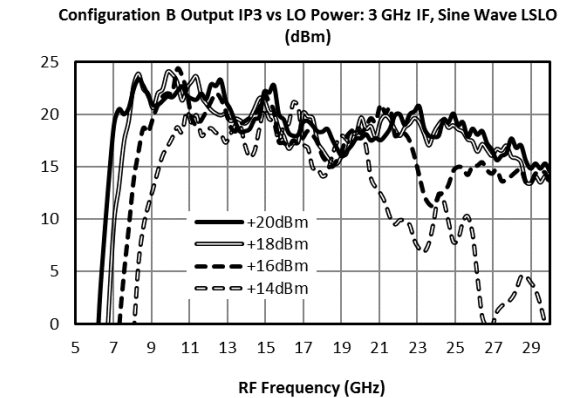
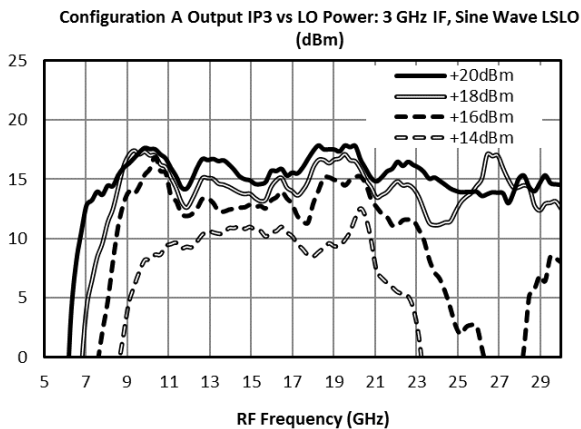
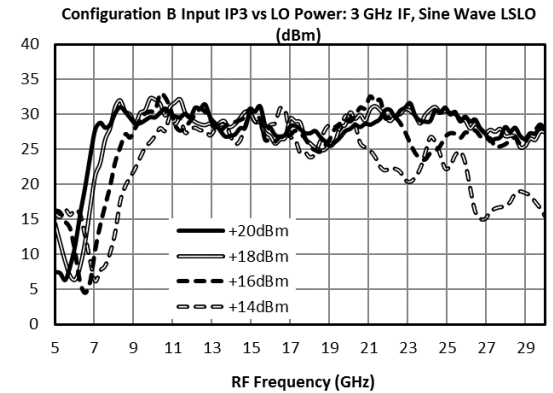
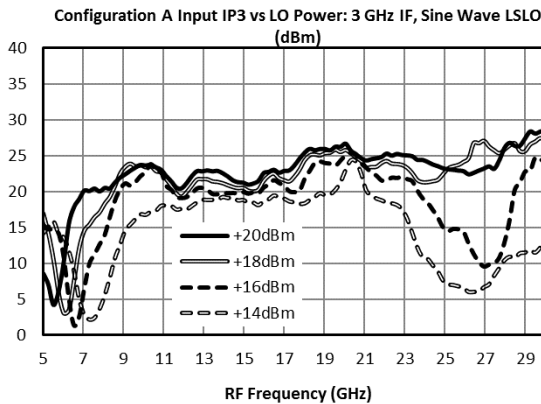
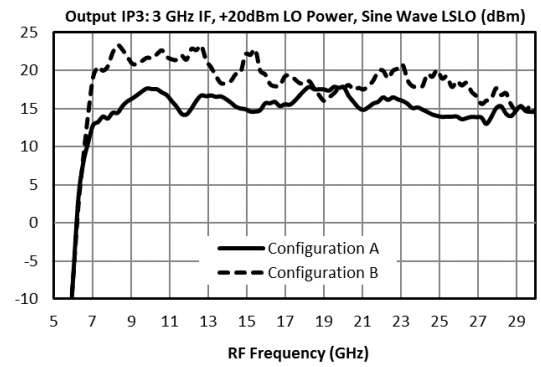
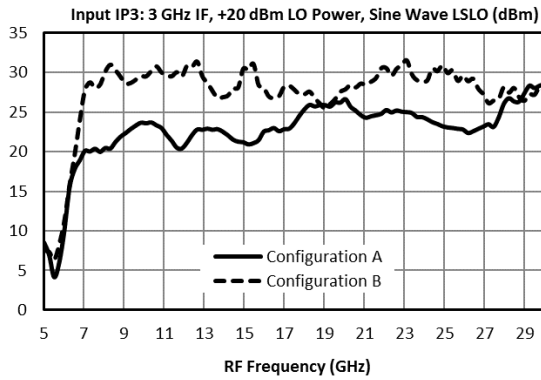

Typical Performance

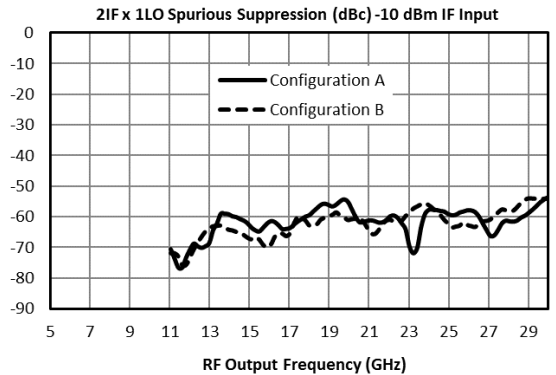
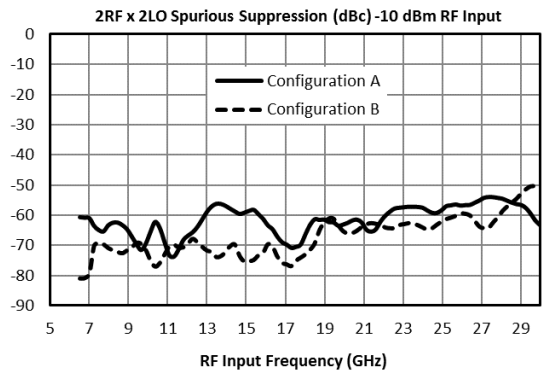
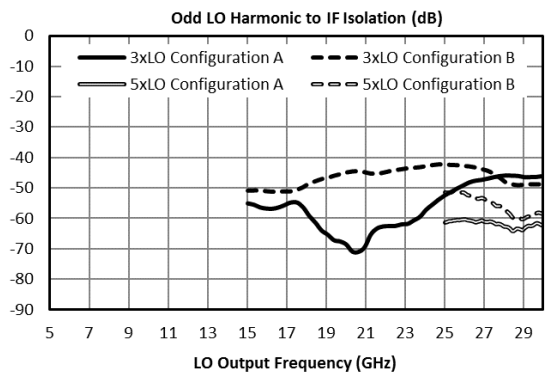
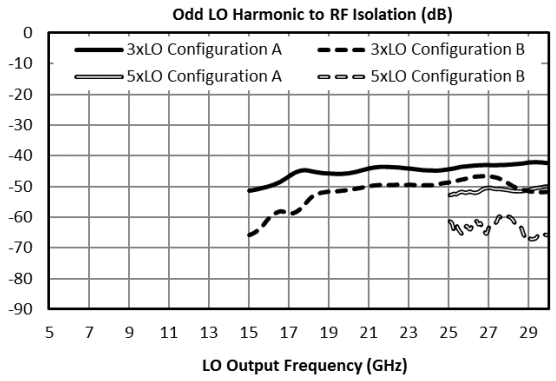
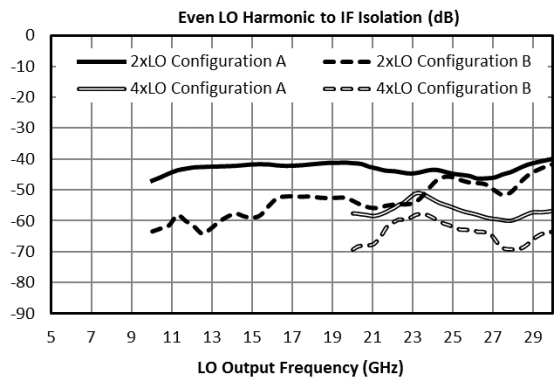
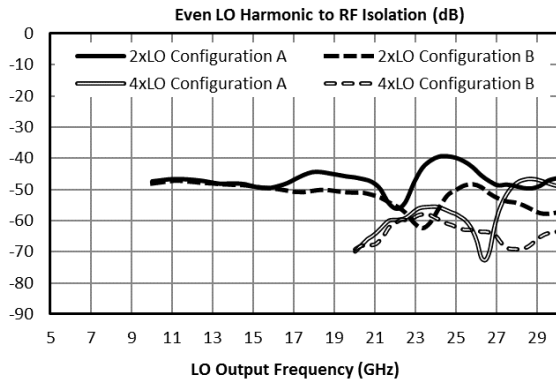



# GaAs MMIC Triple Balanced Mixer

# MM2-0530HSM

Page 7

### Downconversion Spurious Suppression

Spurious data is taken by selecting RF and LO frequencies ( $\pm mLO \pm nRF$ ) within the 5 to 30 GHz RF/LO bands, which create a 3 GHz IF spurious output. The mixer is swept across the full spurious band and the mean is calculated. The numbers shown in the table below are for a -10 dBm RF input. Spurious suppression is scaled for different RF power levels by (n-1), where “n” is the RF spur order. For example, the 2RFx2LO spur is 62 dBc for the A configuration for a -10 dBm input, so a -20 dBm RF input creates a spur that is (2-1) x (-10 dB) dB lower, or 72 dBc.

### Typical Downconversion Spurious Suppression (dBc): A Configuration (B Configuration), Sine Wave LO <sup>5</sup>

-10 dBm RF Input	0xLO	1xLO	2xLO	3xLO	4xLO	5xLO
1xRF	27 (30)	Reference	33 (41)	18 (13)	35 (43)	25 (28)
2xRF	72 (69)	62 (61)	62 (67)	63 (66)	66 (72)	71 (72)
3xRF	107 (102)	74 (80)	95 (95)	78 (84)	96 (102)	79 (87)
4xRF	155 (152)	88 (123)	123 (124)	119 (126)	117 (127)	120 (127)
5xRF	174 (172)	138 (142)	148 (152)	136 (146)	146 (152)	143 (149)

### Upconversion Spurious Suppression

Spurious data is taken by mixing a 3 GHz IF with LO frequencies ( $\pm mLO \pm nIF$ ), which creates an RF within the 5 to 30 GHz RF band. The mixer is swept across the full spurious output band and the mean is calculated. The numbers shown in the table below are for a -10 dBm IF input. Spurious suppression is scaled for different IF input power levels by (n-1), where “n” is the IF spur order. For example, the 2IFx1LO spur is typically 62 dBc for the A configuration for a -10 dBm input, so a -20 dBm IF input creates a spur that is (2-1) x (-10 dB) dB lower, or 72 dBc.



### Typical Upconversion Spurious Suppression (dBc): A Configuration (B Configuration), Sine Wave LO <sup>5</sup>

-10 dBm IF Input	0xLO	1xLO	2xLO	3xLO	4xLO	5xLO
1xIF	30 (34)	Reference	34 (34)	13 (12)	35 (35)	23 (20)
2xIF	77 (73)	62 (62)	63 (62)	63 (67)	72 (69)	59 (65)
3xIF	109 (110)	89 (90)	100 (103)	82 (87)	96 (107)	82 (85)
4xIF	126 (122)	113 (119)	115 (119)	120 (125)	124 (125)	113 (125)
5xIF	145 (154)	130 (140)	141 (152)	132 (148)	141 (145)	124 (139)

# GaAs MMIC Triple Balanced Mixer

# MM2-0530HSM

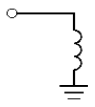
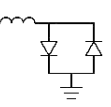
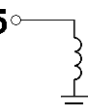
Page 8

Pin	Function	Description	DC Interface Schematic
Pin 4	LO (Configuration A) RF (Configuration B)	Pin 4 is DC short and AC matched to 50 $\Omega$ from 5 to 30 GHz. Blocking capacitor is optional.	<b>Pin 4</b> 
Pin 10	IF	Pin 10 is DC coupled to the diodes. Blocking capacitor is optional.	<b>Pin 10</b> 
Pin 15	RF (Configuration A) LO (Configuration B)	Pin 15 is DC short and AC matched to 50 $\Omega$ from 5 to 30 GHz. Blocking capacitor is optional.	<b>Pin 15</b> 
GND	Ground	SM package ground path is provided through the ground paddle.	<b>GND</b> 

Absolute Maximum Ratings	
Parameter	Maximum Rating
Pin 4 DC Current	21 mA
Pin 10 DC Current	15 mA
Pin 15 DC Current	24 mA
RF Power Handling (RF+LO)	+ 28 dBm at +25°C, derated linearly to +20 dBm at +100°C
Operating Temperature	-55°C to +100°C
Storage Temperature	-65°C to +125°C

**DATA SHEET NOTES:**

- Mixer Conversion Loss Plot IF frequency is 3 GHz unless otherwise specified.
- Mixer Noise Figure typically measures within 0.5 dB of conversion loss for IF frequencies greater than 5 MHz.
- Conversion Loss typically degrades less than 0.5 dB at +100°C and improves less than 0.5 dB at -55°C.
- Unless otherwise specified, data is taken with +20 dBm LO drive.
- Specifications are subject to change without notice. Contact Marki Microwave for the most recent specifications and data sheets.
- Catalog mixer circuits are continually improved. Configuration control requires custom mixer model numbers and specifications.

*Marki Microwave reserves the right to make changes to the product(s) or information contained herein without notice. Marki Microwave makes no warranty, representation, or guarantee regarding the suitability of its products for any particular purpose, nor does Marki Microwave assume any liability whatsoever arising out of the use or application of any product.*

© Marki Microwave, Inc.  
[www.markimicrowave.com](http://www.markimicrowave.com)