

GaAs MMIC Double Balanced Mixer

MM1-0222LSM

1. Device Overview

1.1 General Description

The MM1-0222LSM is a GaAs MMIC double balanced mixer that features excellent conversion loss, superior isolations and spurious performance across a broad bandwidth.

MM1-0222LSM works well as both an up and down converter through Ku band and beyond. The MM1-0222LSM is recommend for low power applications that demand high linearity. If higher LO drive is available, the MM1-0222HSM offers higher linearity in the same surface mount package. The MM1-0222LSM is available in a 3x3 mm QFN package. Evaluation boards are also available. For a list of recommended LO driver amps for all mixers and IQ mixers, see [here](#).



QFN

1.2 Features

Parameter	Typical
RF/LO response	2GHz - 22GHz
IF response	DC – 3.5 GHz
Conversion Loss	7 dB
LO to RF Isolation	50dB

1.3 Applications

- Test and measurement equipment
- SATCOM
- Radar
- Electronic Warfare

1.4 Functional Block Diagram

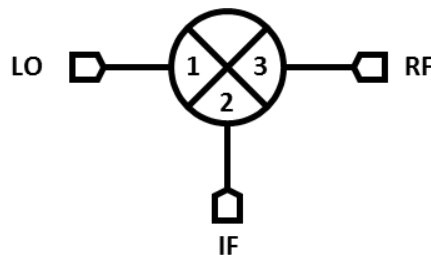

1.5 Part Ordering Options¹

Part Number	Description	Package	Green Status	Product Lifecycle	Export Classification
MM1-0222LSM-2	3x3 mm QFN	SM	RoHS	Active	EAR99
EVAL-MM1-0222L	Connectorized Evaluation Fixture	Eval		Active	EAR99

¹ Refer to our [website](#) for a list of definitions for terminology presented in this table.

Table of Contents

1. Device Overview	1	3.6 Typical Performance Plots	6
1.1 General Description	1	3.6.1 Typical Performance Plots: IP3 ..	8
1.2 Features	1	3.6.2 Typical Performance Plots: LO	
1.3 Applications	1	Harmonic Isolation.....	9
1.4 Functional Block Diagram	1	3.6.3 Typical Spurious Performance:	
1.5 Part Ordering Options.....	1	Down-Conversion	10
2. Port Configurations and Functions	3	3.6.4 Typical Spurious Performance: Up-	
2.1 Port Diagram	3	Conversion	10
2.2 Port Functions	3	4. Operation.....	11
3. Specifications	4	4.1 Application Circuit	11
3.1 Absolute Maximum Ratings.....	4	4.2 Ports Operation	11
3.2 Package Information	4	5. Mechanical Data.....	12
3.3 Recommended Operating Conditions .	4	5.1 SM Package Outline Drawing.....	12
3.4 Sequencing Requirements	4	5.2 SM Package Footprint	12
3.5 Electrical Specifications	5	5.3 Evaluation Board Outline Drawing...	13

Revision History

Revision Code	Revision Date	Comment
-	February 2020	Initial Release
A	March 2020	Power Handling Updated



2. Port Configurations and Functions

2.1 Port Diagram

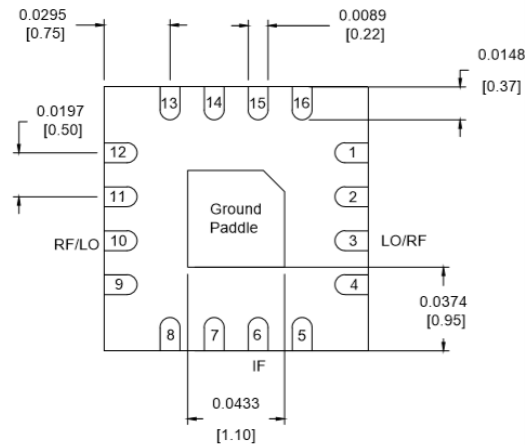
A bottom-up view of the MM1-0222LSM's SM package outline drawing is shown below. The MM1-0222LSM has the input and output ports given in Port Functions. The MM1-0222LSM can be used in either an up or down conversion. For configuration A, input the LO into pin 3, use pin 10 for the RF, and port 6 for the IF. For configuration B, input the LO into pin 10, use pin 3 for the RF, and pin 6 for the IF.

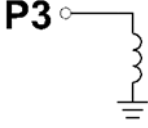
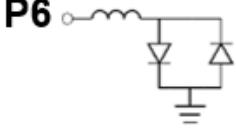
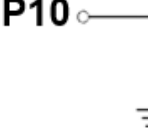

2.2 Port Functions

Port	Function	Description	Equivalent Circuit for Package
Pin 3	LO (Configuration A) RF (Configuration B)	Pin 3 is DC short and AC matched to 50 Ohms from 2 to 22 GHz. Blocking capacitor is optional.	
Pin 6	IF	Pin 6 is DC coupled to the diodes. Blocking capacitor is optional.	
Pin 10	RF (Configuration A) LO (Configuration B)	Pin 10 is DC short and AC matched to 50 Ohms from 2 to 22 GHz. Blocking capacitor is optional.	
GND	Ground	SM package ground path is provided through the ground paddle.	

3. Specifications

3.1 Absolute Maximum Ratings

The Absolute Maximum Ratings indicate limits beyond which damage may occur to the device. If these limits are exceeded, the device may be inoperable or have a reduced lifetime.

Parameter	Maximum Rating	Units
Pin 3 DC Current	30	mA
Pin 6 DC Current	30	mA
Pin 10 DC Current	30	mA
Power Handling, at any Port	+30	dBm
Operating Temperature	-55 to +100	°C
Storage Temperature	-65 to +125	°C

3.2 Package Information

Parameter	Details	Rating
ESD	Human Body Model (HBM), per MIL-STD-750, Method 1020	1A
Weight	EVAL package	11g

3.3 Recommended Operating Conditions

The Recommended Operating Conditions indicate the limits, inside which the device should be operated, to guarantee the performance given in Electrical Specifications. Operating outside these limits may not necessarily cause damage to the device, but the performance may degrade outside the limits of the electrical specifications. For limits, above which damage may occur, see Absolute Maximum Ratings.

	Min	Nominal	Max	Units
T _A , Ambient Temperature	-55	+25	+100	°C
LO Input Power	+7		+15	dBm

3.4 Sequencing Requirements

There is no requirement to apply power to the ports in a specific order. However, it is recommended to provide a 50Ω termination to each port before applying power. This is a passive diode mixer that requires no DC bias.

3.5 Electrical Specifications

The electrical specifications apply at $T_A = +25^\circ\text{C}$ in a 50Ω system. Typical data shown is for a down conversion application with a +12dBm sine wave LO input. Specifications shown for configuration A (B).

Parameter		Test Conditions	Min	Typical	Max	Units
RF (Pin 10) Frequency Range			2		22	GHz
LO (Pin 3) Frequency Range			2		22	
I (Pin 6) Frequency Range			0		3.5	
Conversion Loss (CL) ²		RF/LO = 2 - 22 GHz I = DC - 0.2 GHz		7 (9)	11 (12)	dB
Noise Figure (NF) ³		RF/LO = 2 - 22 GHz I = DC - 0.2 GHz		7		dB
Isolation	LO to RF	RF/LO = 2 - 22 GHz		50		dB
	LO to IF	IF/LO = 2 - 22 GHz		27		
	RF to IF	RF/IF = 2 - 22 GHz		31		
Input IP3 (IIP3)		RF/LO = 2 - 22 GHz I = DC - 0.2 GHz		+11 (+13)		dBm
Input 1 dB Gain Compression Point (P1dB)				+3 (+5.5)		dBm

² Measured as a down converter to a fixed 91MHz IF.

³ Mixer Noise Figure typically measures within 0.5 dB of conversion loss for IF frequencies greater than 5 MHz.

3.6 Typical Performance Plots

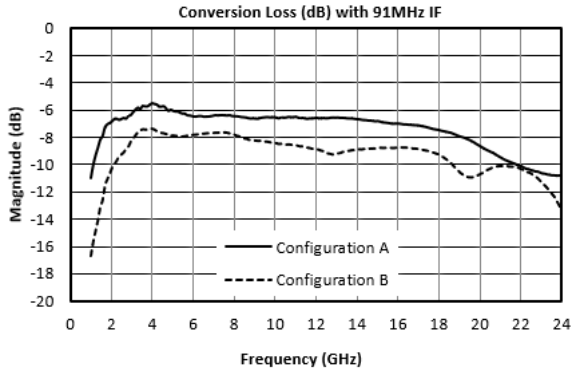

This space is intentionally left blank

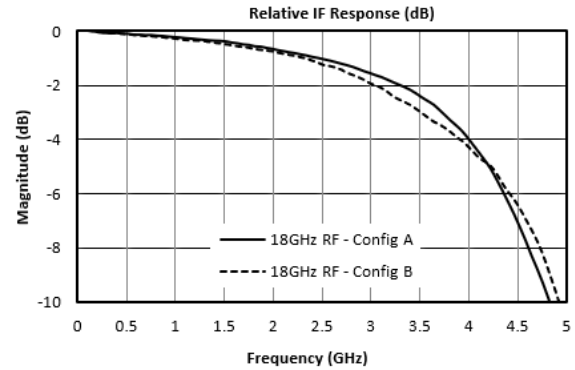
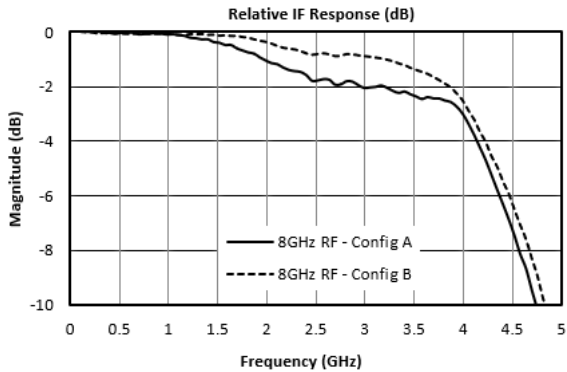
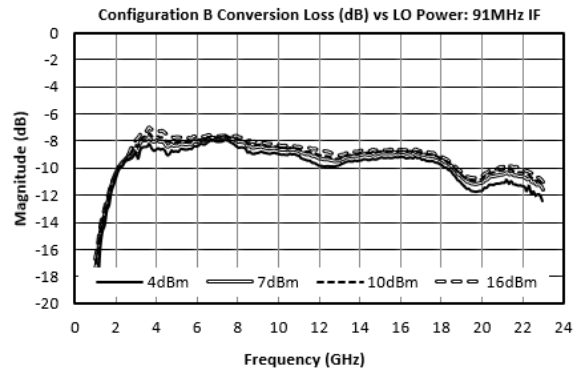
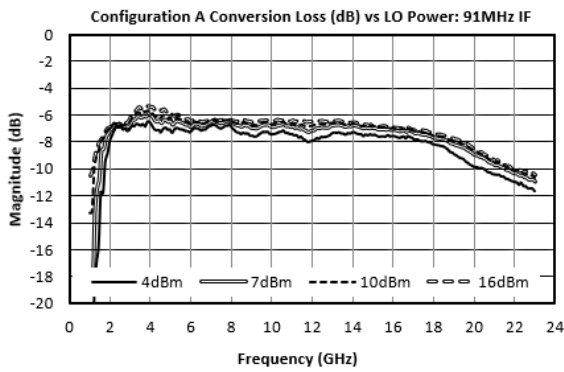

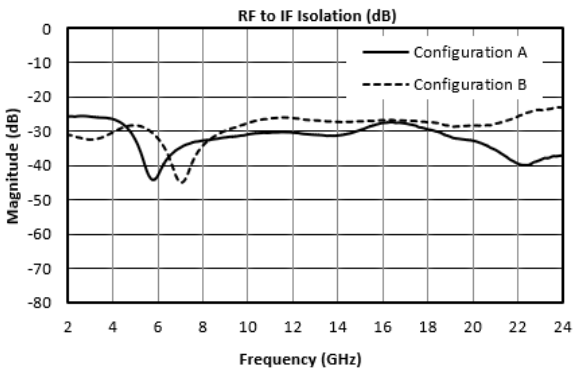
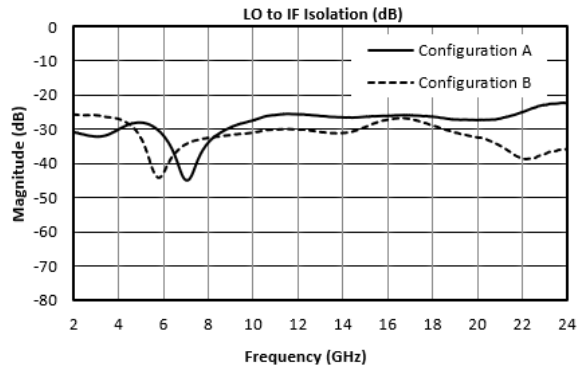
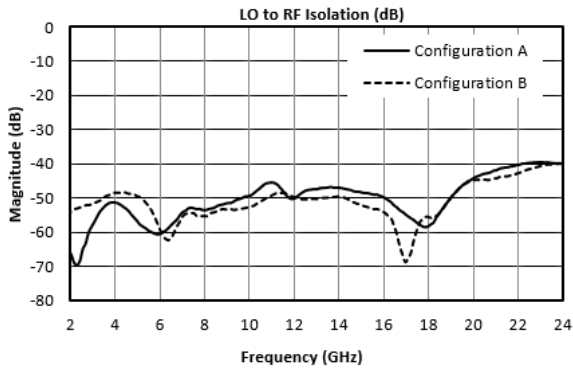

This space is intentionally left blank

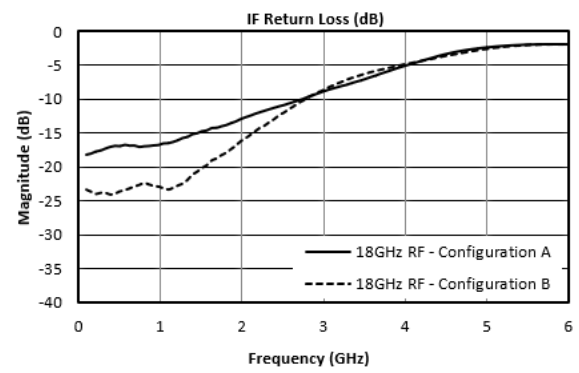
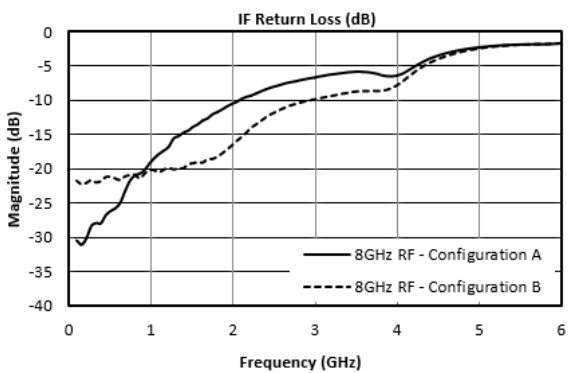
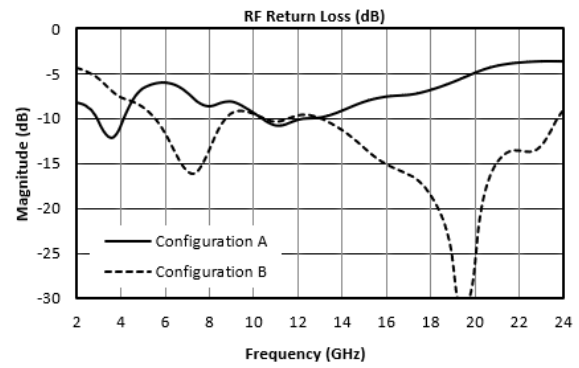
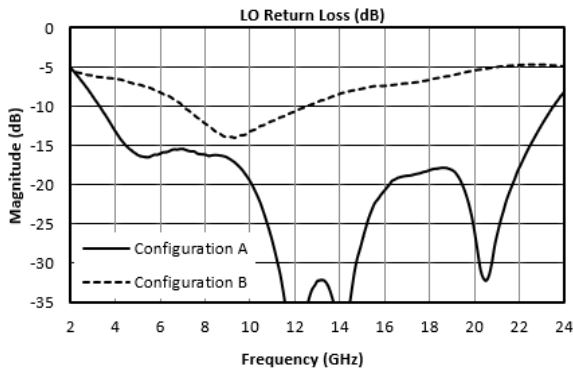

3.6.1 Typical Performance Plots: IP3

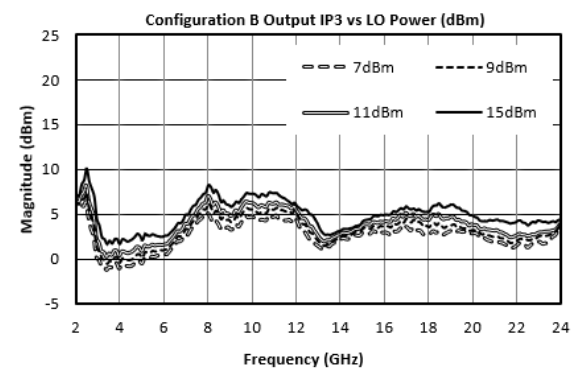
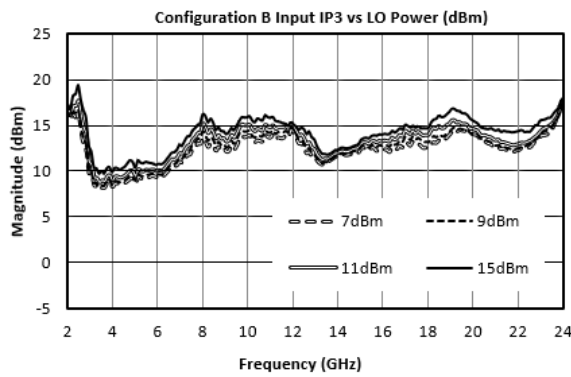
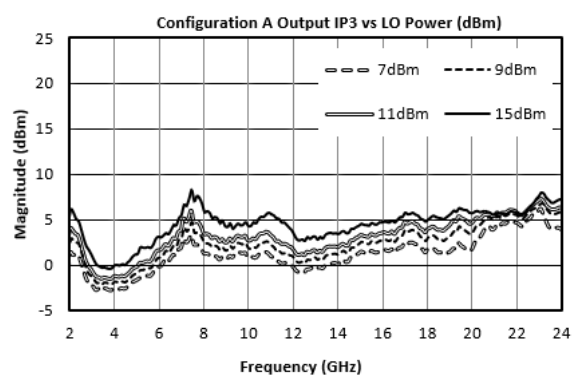
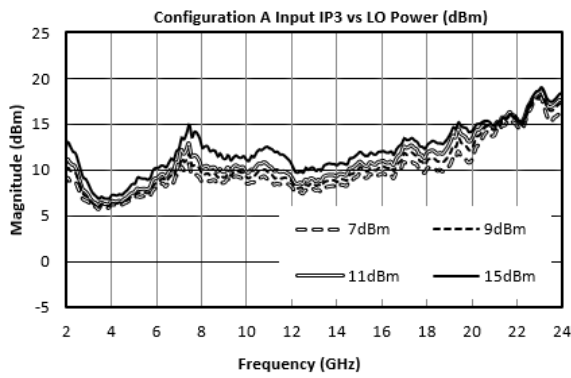
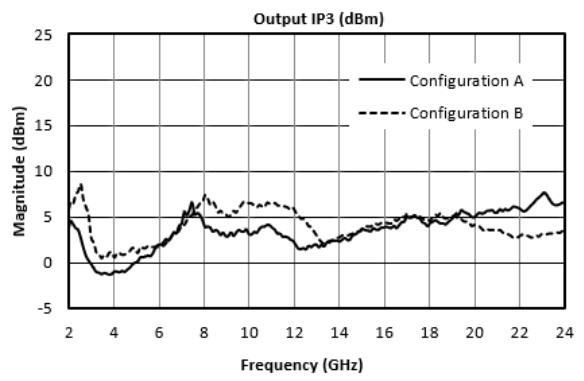
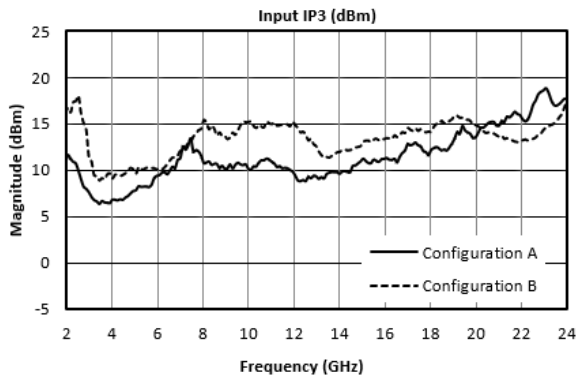

3.6.2 Typical Performance Plots: LO Harmonic Isolation

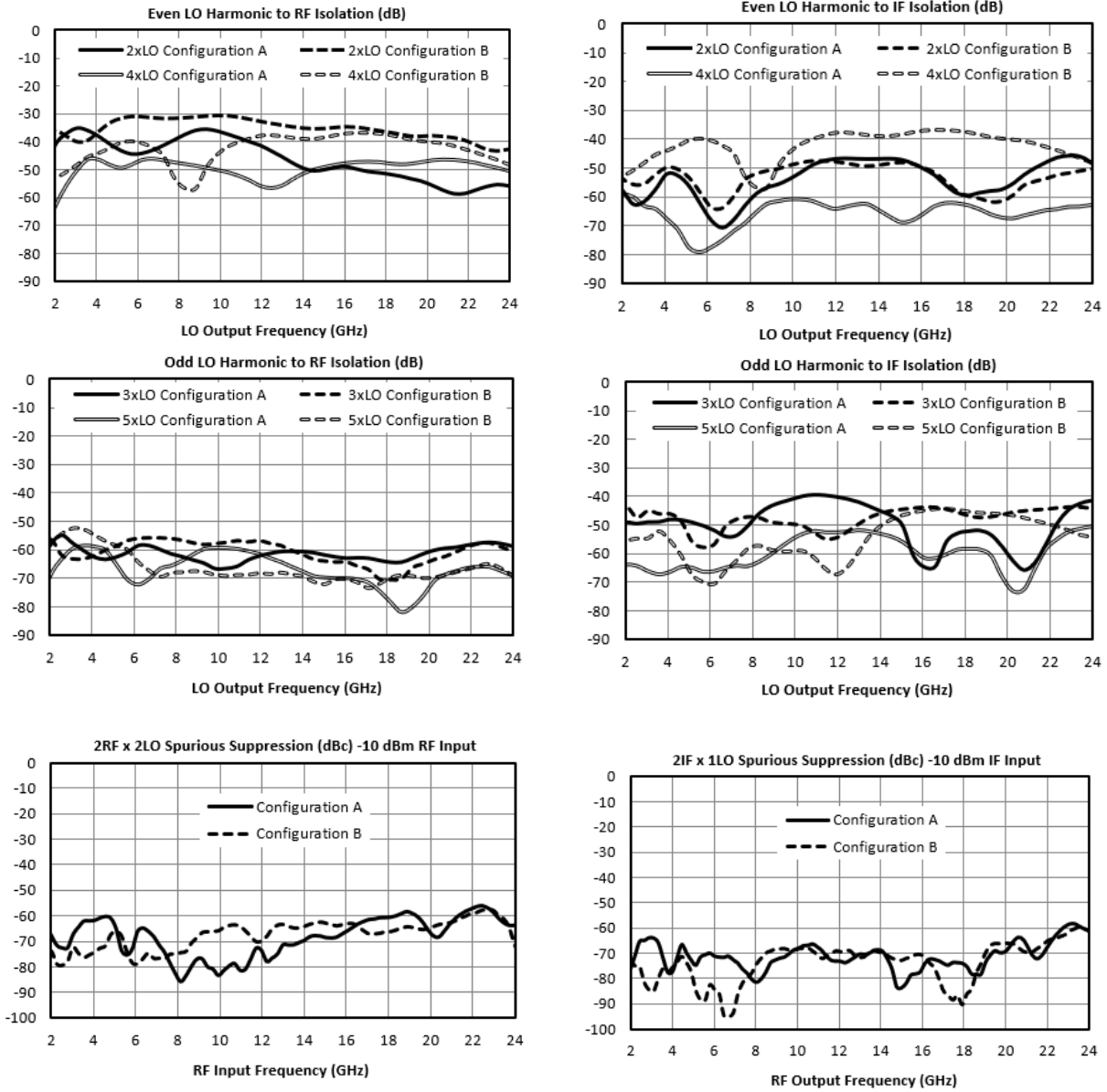

3.6.3 Typical Spurious Performance: Down-Conversion

Typical spurious data is provided by selecting RF and LO frequencies ($\pm m \cdot \text{LO} \pm n \cdot \text{RF}$) within the RF/LO bands, to create a spurious output within the IF band. The mixer is swept across the full spurious band and the mean is calculated. The numbers shown in the table below are for a -10 dBm RF input. Spurious suppression is scaled for different RF power levels by $(n-1)$, where "n" is the RF spur order. For example, the 2RF x 2LO spur is 68 dBc for a -10 dBm input, so a -20 dBm RF input creates a spur that is $(2-1) \times (-10 \text{ dB})$ lower, or 78 dBc. Data is shown for the frequency plan in 3.6 Typical Performance. mLOxORF plots can be found in section 3.6.2 Typical Performance Plots: LO Harmonic Isolation. OLOx1RF plot is identical to the plot of LO-RF isolation.

Typical Down-conversion spurious suppression (dBc): Config A (B)

-10 dBm RF Input	0xLO	1xLO	2xLO	3xLO	4xLO	5xLO
1xRF	23 (17)	Reference	28 (38)	12 (10)	34 (41)	22 (17)
2xRF	59 (67)	46 (45)	68 (69)	54 (46)	63 (59)	59 (45)
3xRF	74 (77)	58 (68)	76 (92)	66 (69)	81 (91)	70 (71)
4xRF	115 (122)	107 (108)	108 (114)	108 (106)	115 (119)	113 (105)
5xRF	124 (137)	112 (127)	116 (129)	105 (118)	122 (137)	118 (120)

3.6.4 Typical Spurious Performance: Up-Conversion

Typical spurious data is taken by mixing an input within the IF band, with LO frequencies ($\pm m \cdot \text{LO} \pm n \cdot \text{IF}$), to create a spurious output within the RF output band. The mixer is swept across the full spurious output band and the mean is calculated. The numbers shown in the table below are for a -10 dBm IF input. Spurious suppression is scaled for different IF input power levels by $(n-1)$, where "n" is the IF spur order. For example, the 2IFx1LO spur is typically 71 dBc for a -10 dBm input with a sine-wave LO, so a -20 dBm IF input creates a spur that is $(2-1) \times (-10 \text{ dB})$ lower, or 81 dBc. Data is shown for the frequency plan in 3.6 Typical Performance.

Typical Up-conversion spurious suppression (dBc): Config A (B)

-10 dBm IF Input	0xLO	1xLO	2xLO	3xLO	4xLO	5xLO
1xIF	27 (18)	Reference	54 (61)	42 (48)	56 (63)	52 (55)
2xIF	46 (47)	71 (74)	49 (46)	59 (70)	50 (44)	72 (64)
3xIF	79 (76)	63 (69)	76 (90)	60 (65)	76 (87)	66 (65)
4xIF	129 (119)	110 (121)	105 (103)	110 (121)	98 (97)	112 (114)
5xIF	137 (144)	111 (119)	122 (141)	101 (114)	116 (131)	107 (108)

4. Operation

4.1 Application Circuit

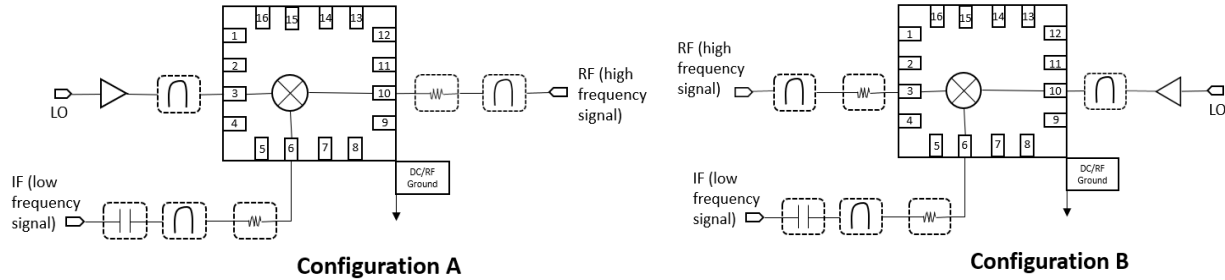

4.2 Ports Operation

IF Port – Used as input on an upconversion, output on downconversion, or LO port in a band shifting application. Signals should be connected by 50 ohm microstrip or coplanar traces to well matched broadband 50 ohm sources and loads. Blocking capacitor is recommended if DC voltage is present on the line.

RF Port – Used as input on a downconversion, output on upconversion, or output in a band shifting application. Signals should be connected by 50 ohm microstrip or coplanar traces to well matched broadband 50 ohm sources and loads.

Filtering and Matching- Filtering is generally desired for spurious and image removal on the output port of the mixer. Reflective filters can cause out of band signals to reflect back into the mixer and cause conversion loss ripple, erroneous spurs, and other undesired behaviors. To eliminate these problems it is recommended that the filters be placed as close to the output port as possible. If undesired behavior is still observed, a diplexer with one port terminated or a 1-3 dB attenuator may reduce this problem.

RF Ground – The ground paddle of the QFN should be connected to a low noise RF ground with very low electrical resistance for high frequency operation.

LO Port – The noise floor of the LO input signal should be less than the value of the noise floor plus isolation of the mixer, or a filter is recommended to prevent reduction in dynamic range. An LO amplifier is required if the LO power is below the recommended drive level. It is important to use an amplifier with a broadband 50 ohm match such that it does not reflect spurious signals back into the mixer or other system circuitry.

5. Mechanical Data

5.1 SM Package Outline Drawing

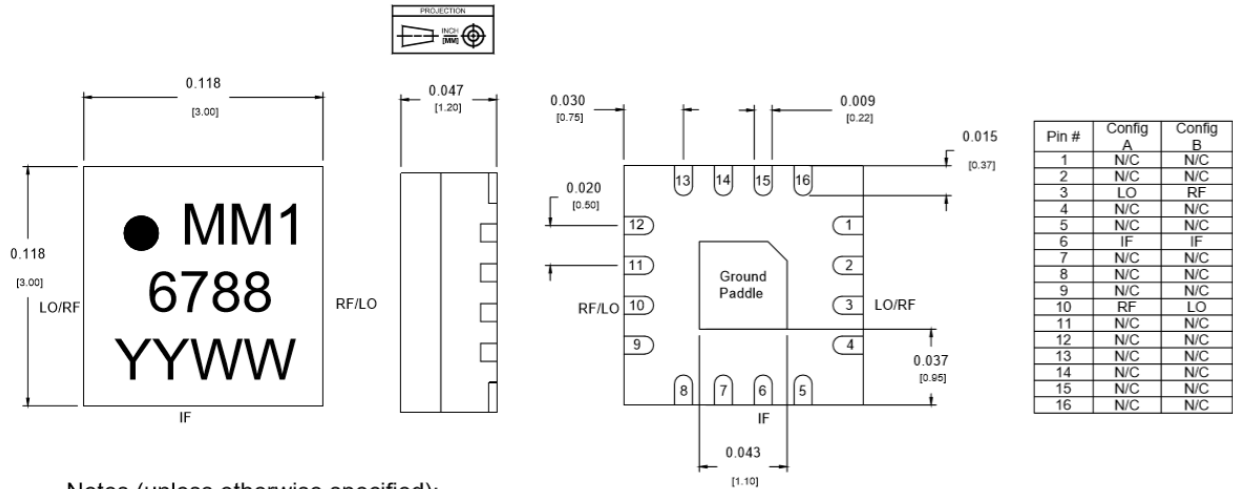

Notes (unless otherwise specified):

- Substrate material is LCP.
- I/O Leads and Die Paddle is (from base to finish):
 Ni: 0.5um MIN
 Pd: 0.02um MIN
 Au: 0.05um MAX
- All unconnected pins should be connected to PCB RF ground.

5.2 SM Package Footprint

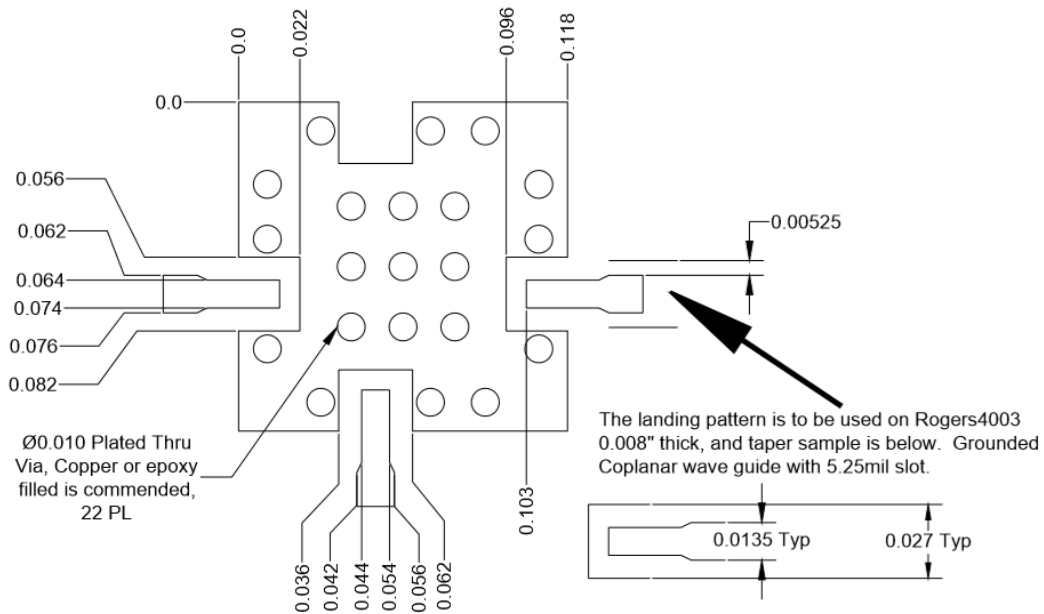

QFN-Package Surface-Mount Landing Pattern

[Click here for a DXF of the above layout.](#)

[Click here for leaded solder reflow.](#) [Click here for lead-free solder reflow.](#)

5.3 Evaluation Board Outline Drawing

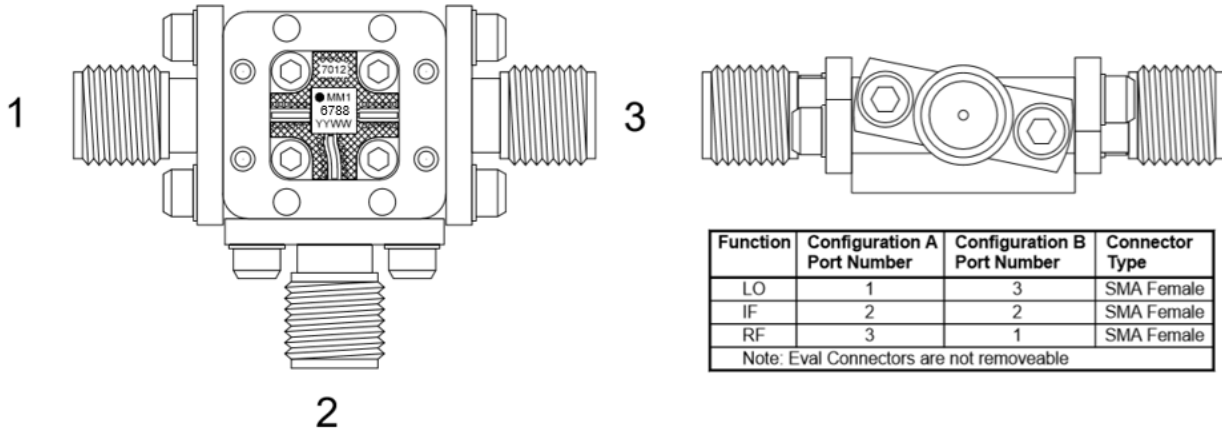

Marki Microwave reserves the right to make changes to the product(s) or information contained herein without notice.

Marki Microwave makes no warranty, representation, or guarantee regarding the suitability of its products for any particular purpose, nor does Marki Microwave assume any liability whatsoever arising out of the use or application of any product.