

MICROLITHIC® DOUBLE-BALANCED I/Q MIXER

MLIQ-1845

The MLIQ-1845 is a miniaturized, multi-octave 18-45 GHz IQ mixer. It features matched double balanced mixers connected with an integrated LO hybrid and RF power divider. It can be used for either up or downconversion. Applications include optical communications systems with advanced modulation formats, communications or radar systems with advanced digital modulation formats and phase modulated signals, test and measurement, or electronic warfare. Image reject or single sideband modulation with excellent suppression is possible with use of an external IF quadrature (90°) hybrid.

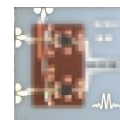

Features

- Compact Chip Style Package (0.240" x 0.240"x0.010")
- CAD Optimized for Superior Amplitude / Phase Balance and Image Rejection
- Broadband Performance
- Excellent Unit-to-Unit Repeatability
- Fully nonlinear software models available with Marki PDK for Microwave Office
- RoHS Compliant

Electrical Specifications - Specifications guaranteed from -55 to +100°C, measured in a 50Ω system.

Parameter	LO (GHz)	RF (GHz)	IF (GHz)	Min	Typ	Max	Diode Option ¹ LO drive level (dBm)	
Conversion Loss (dB) (Combined IF with Test Hybrid)	18-45		DC-6		8	13		
			6-20		10	15		
Image Rejection (dB) (Combined IF with Test Hybrid)					See Plots			
I/Q Amplitude Balance (dB)					0.11			
I/Q Quadrature Phase Balance (Degrees)					5			
Isolation (dB) LO-RF LO-IF RF-IF					See Plots			
Input 1 dB Compression (dBm) (Combined IF with Test Hybrid)						+8 +13		L (+11 to +18) I (+18 to +24)
Input Two-Tone Intercept (dBm) (Combined IF with Test Hybrid)						+15 +20		L (+11 to +18) I (+18 to +24)

¹Contact factory for other diode options.

Part Number Options¹

Part Number	Description	Package	Green Status	Product Lifecycle	Export Classification	Recommended Part Number
MLIQ-1845LCH-2	Chip	CH	RoHS Compliant	Active Not Recommended for New Designs	EAR99	MMIQ-1040LCH-2
MLIQ-1845ICH-2	Chip	CH				MMIQ-1037HCH-2
MLIQ-1845L	Connectorized	-				MMIQ-1040LS
MLIQ-1845I	Connectorized	-				MMIQ-1037HS

¹Refer to our [website](#) for a list of definitions for terminology presented in this table.

MICROLITHIC® DOUBLE-BALANCED I/Q MIXER

MLIQ-1845

Page 2

LO/RF 18 to 45 GHz
IF DC to 20 GHz

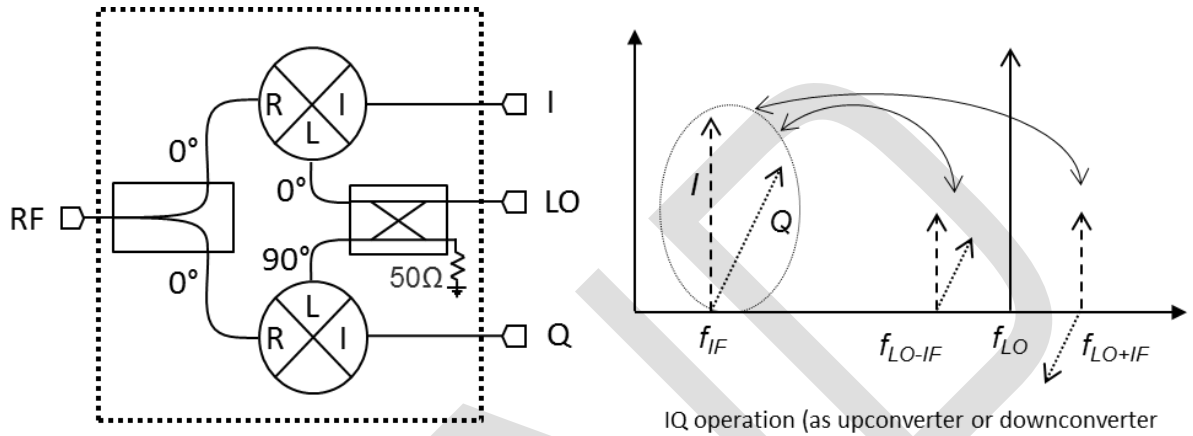

Figure 1a. I/Q Mixer Schematic

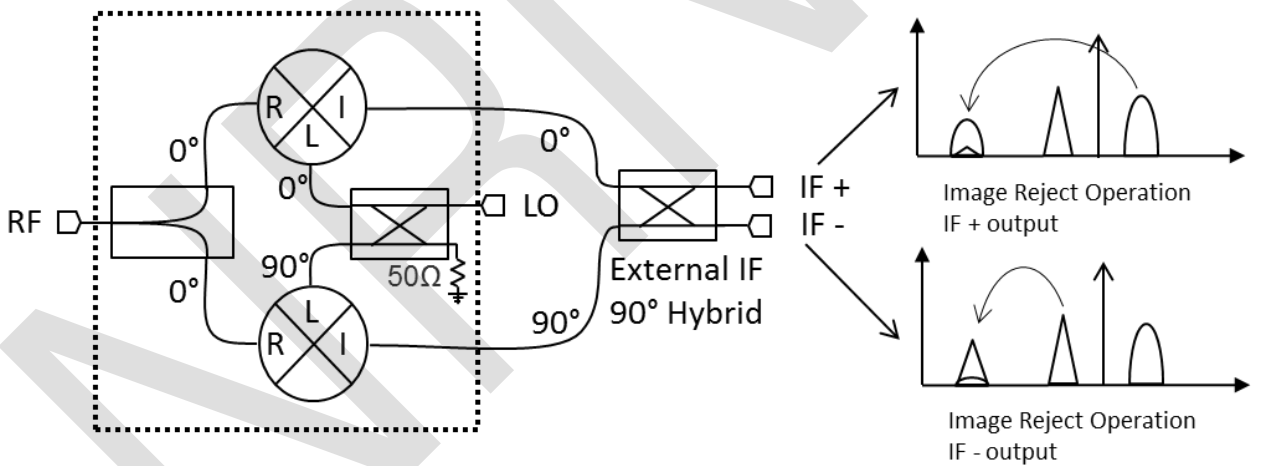

Figure 1b. Image Reject Mixer Schematic

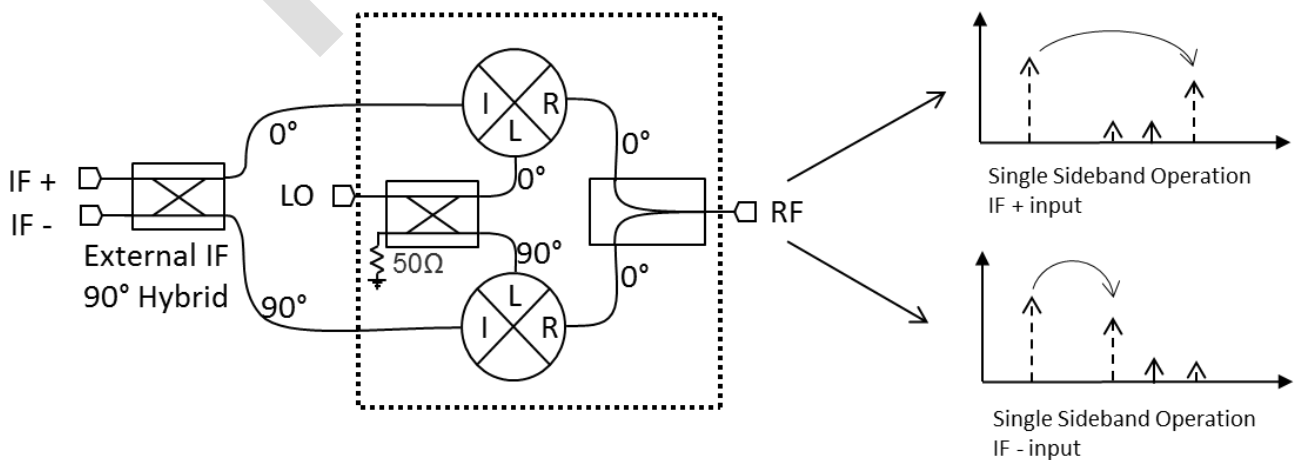

Figure 1c. Single Sideband Mixer Schematic



MICROLITHIC® DOUBLE-BALANCED I/Q MIXER

MLIQ-1845

Page 3

LO/RF 18 to 45 GHz
IF DC to 20 GHz

Typical Performance

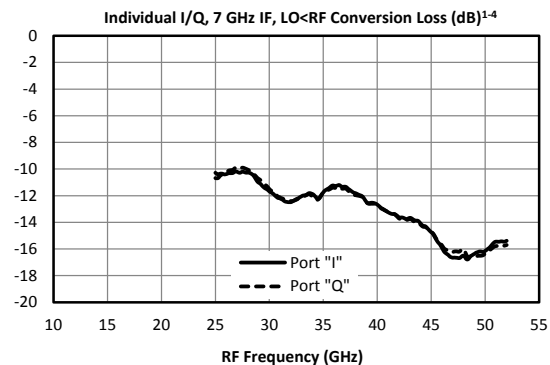
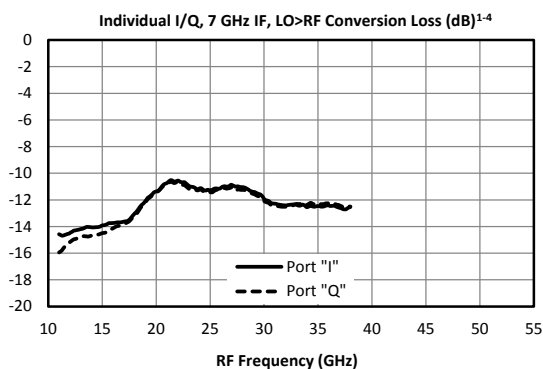
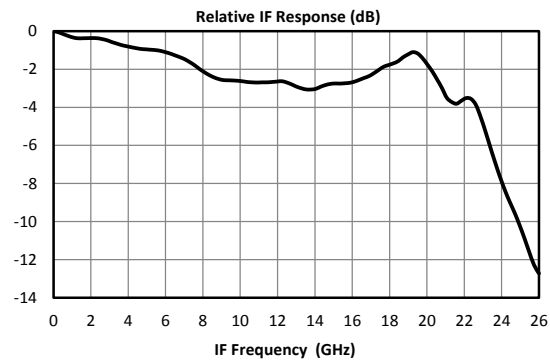
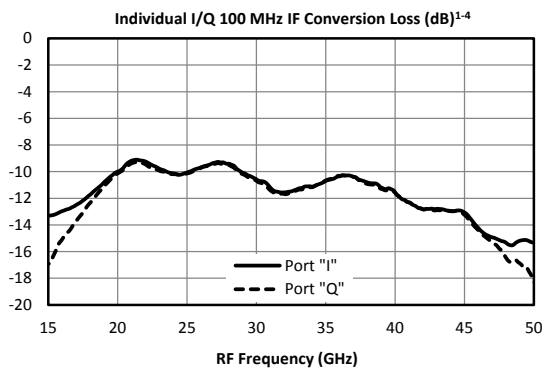
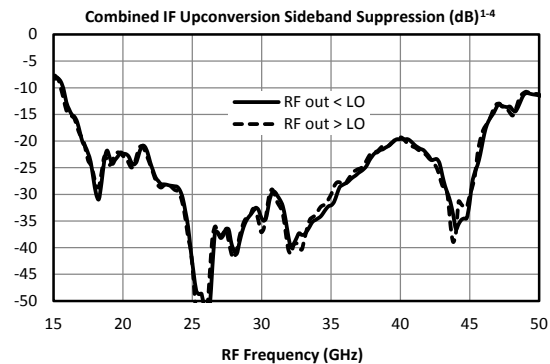
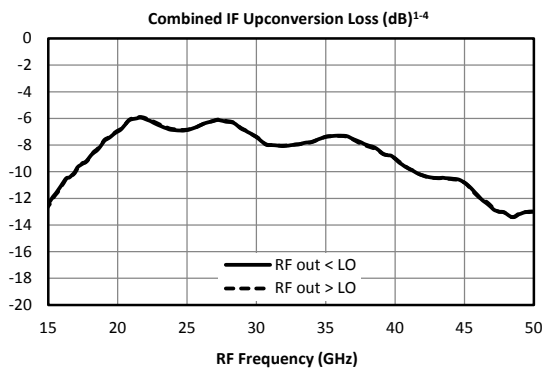
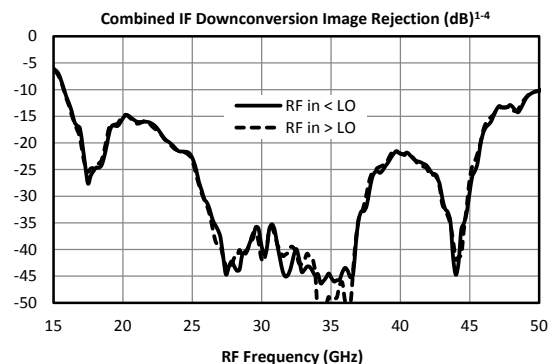
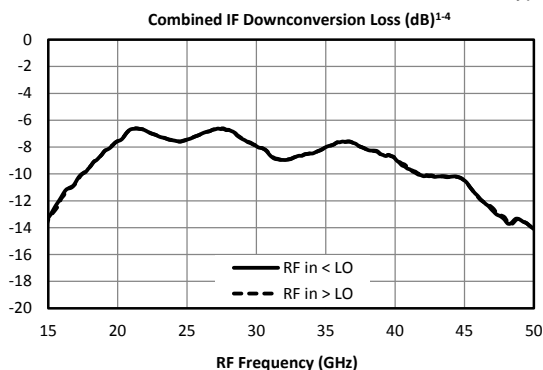



MICROLITHIC® DOUBLE-BALANCED I/Q MIXER

MLIQ-1845

Page 4

LO/RF 18 to 45 GHz
IF DC to 20 GHz

Typical Performance (cont.)

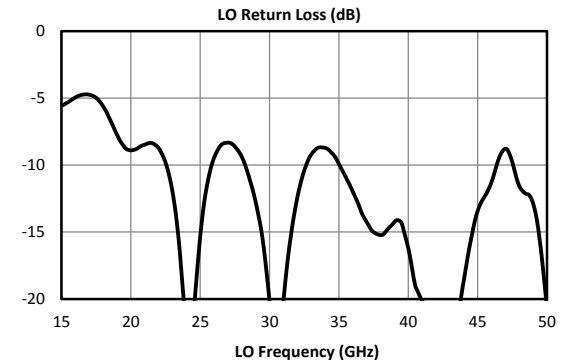
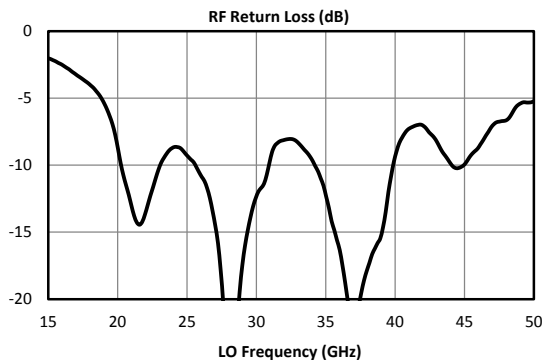
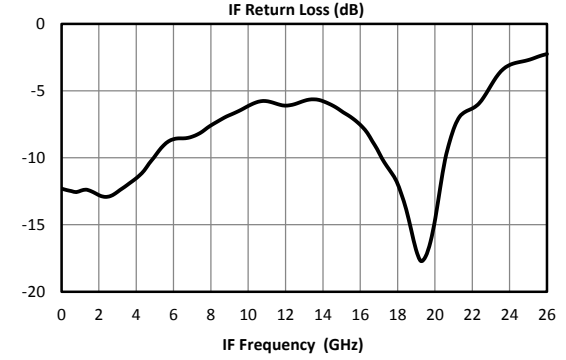
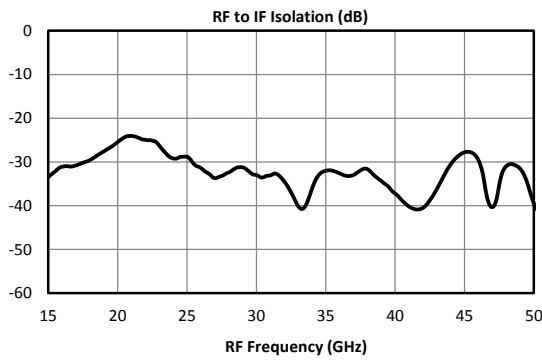
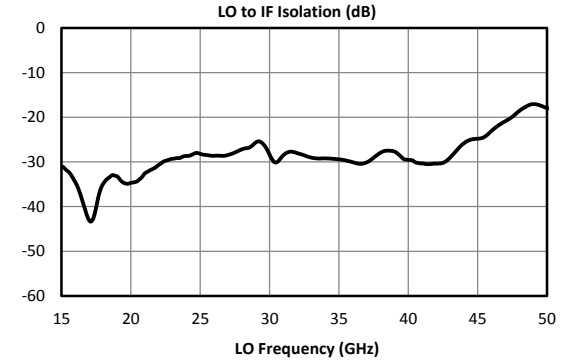
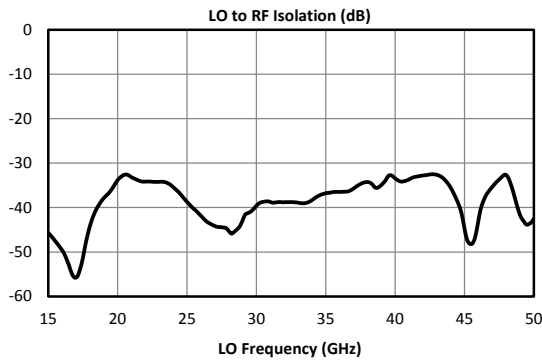
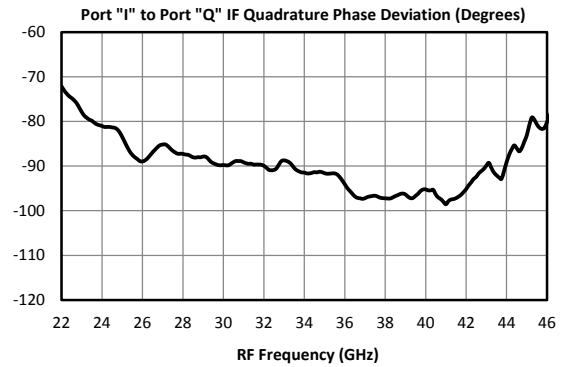
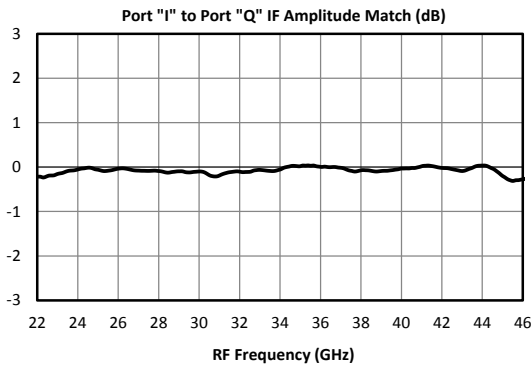

MICROLITHIC® DOUBLE-BALANCED I/Q MIXER

MLIQ-1845

Page 5

LO/Rf 18 to 45 GHz
IF DC to 20 GHz

Typical Performance (cont.)

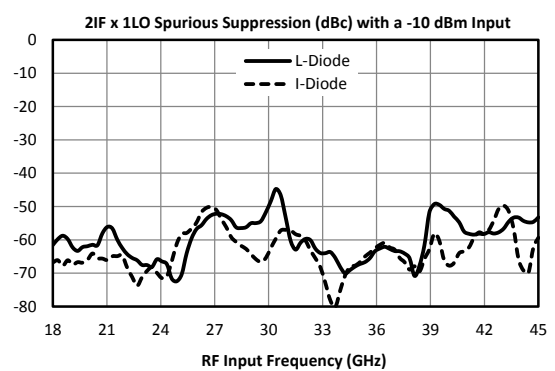
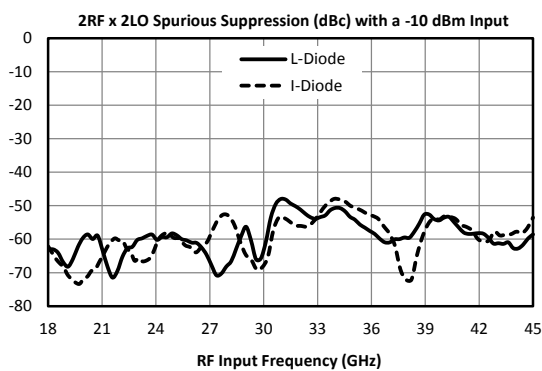
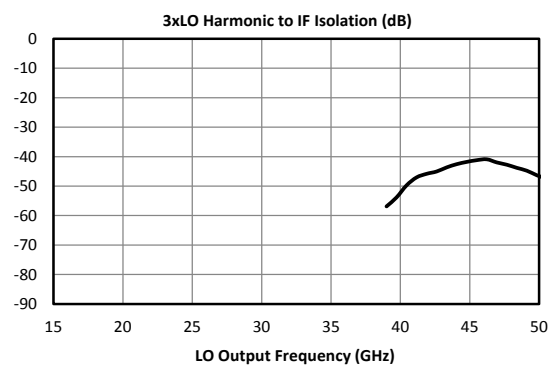
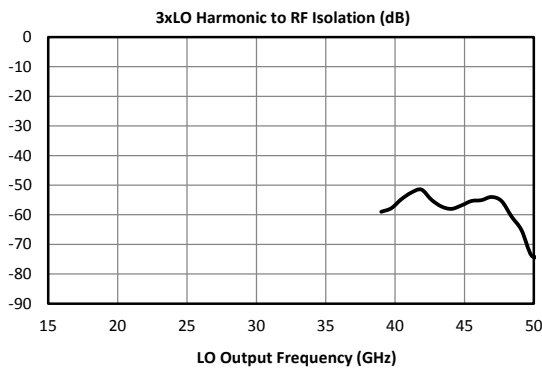
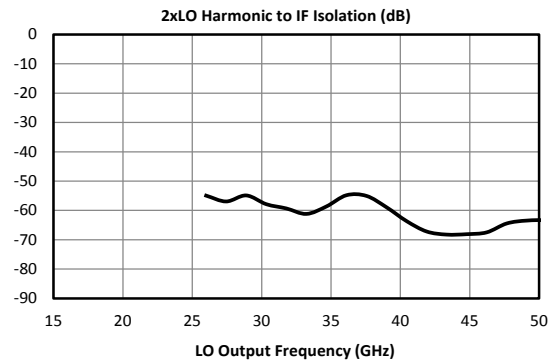
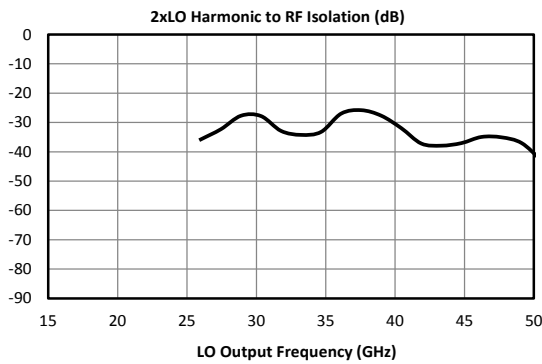
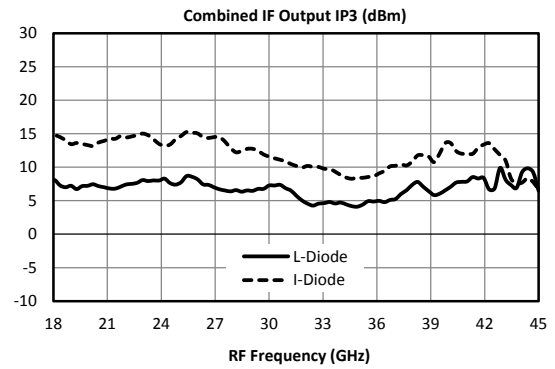
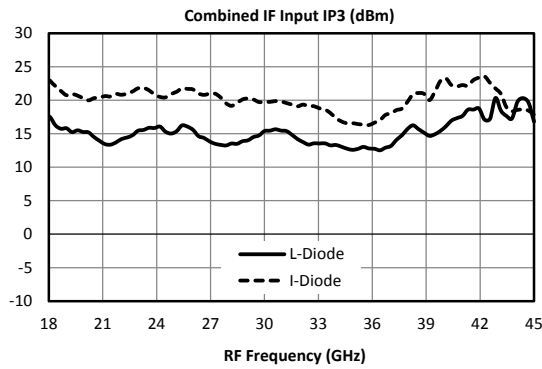

MICROLITHIC® DOUBLE-BALANCED I/Q MIXER

MLIQ-1845

Page 6

LO/RF 18 to 45 GHz
IF DC to 20 GHz

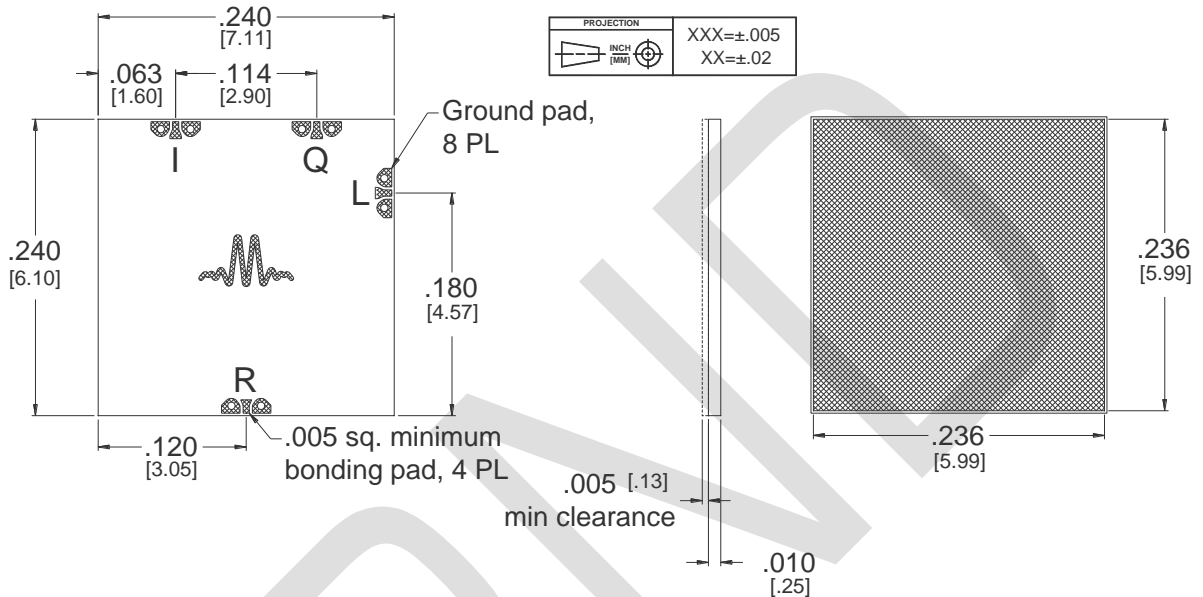

Figure 2a. Outline Drawing – CH-2

*CH Substrate material is .010 thick Ceramic.

I/O traces and ground plane finish is 2.5 microns Au over .05 microns WTi.

Wire Bonding - Ball or wedge bond with 0.025 mm (1 mil) diameter pure gold wire. Thermosonic wirebonding with a nominal stage temperature of 150 °C and a ball bonding force of 40 to 50 grams or wedge bonding force of 18 to 22 grams is recommended. Use the minimum level of ultrasonic energy to achieve reliable wirebonds. Wirebonds should be started on the chip and terminated on the package or substrate. All bonds should be as short as possible <0.31 mm (12 mils).

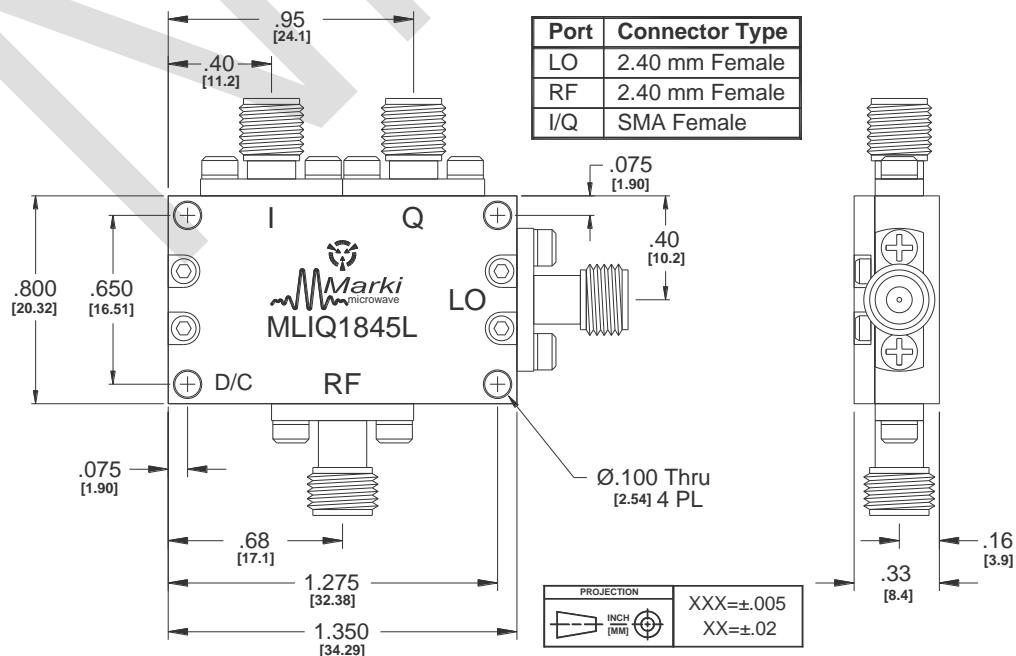

Figure 2b. Outline Drawing - Connectorized



MICROLITHIC® DOUBLE-BALANCED I/Q MIXER

MLIQ-1845

Page 7

LO/RF 18 to 45 GHz
IF DC to 20 GHz

Downconversion Spurious Suppression

Spurious data is taken by selecting RF and LO frequencies ($\pm mLO \pm nRF$) within the RF/LO bands, to create a spurious output within the IF band. The mixer is swept across the full spurious band and the mean is calculated. The numbers shown in the table below are for a -10 dBm RF input. Spurious suppression is scaled for different RF power levels by $(n-1)$, where “n” is the RF spur order. For example, the $2RF \times 2LO$ spur is 59 dBc for a -10 dBm input, so a -20 dBm RF input creates a spur that is $(2-1) \times (-10 \text{ dB})$ dB lower, or 69 dBc.

Typical Downconversion Spurious Suppression (dBc): L-diode (I-Diode) ⁵

-10 dBm RF Input	0xLO	1xLO	2xLO	3xLO	4xLO	5xLO
1xRF	21 (21)	Reference	29 (25)	11 (16)	N/A	N/A
2xRF	55 (69)	59 (59)	59 (60)	60 (68)	62 (68)	57 (65)
3xRF	86 (87)	58 (66)	75 (77)	62 (68)	77 (88)	66 (82)
4xRF	N/A	112 (113)	98 (99)	102 (107)	100 (102)	103 (118)
5xRF	N/A	N/A	110 (123)	105 (117)	116 (123)	105 (120)

Upconversion Spurious Suppression

Spurious data is taken by mixing an input within the IF band, with LO frequencies ($\pm mLO \pm nIF$), to create a spurious output within the RF output band. The mixer is swept across the full spurious output band and the mean is calculated. The numbers shown in the table below are for a -10 dBm individual IF input, with the unused port terminated in 50 ohms. Spurious suppression is scaled for different IF input power levels by $(n-1)$, where “n” is the IF spur order. For example, the $2IF \times 1LO$ spur is typically 60 dBc for a -10 dBm input, so a -20 dBm IF input creates a spur that is $(2-1) \times (-10 \text{ dB})$ dB lower, or 70 dBc.

Typical Upconversion Spurious Suppression (dBc): L-diode (I-Diode) ⁵

-10 dBm IF Input	0xLO	1xLO	2xLO	3xLO	4xLO	5xLO
1xIF	16 (12)	Reference	22 (15)	9 (14)	N/A	N/A
2xIF	56 (57)	60 (64)	59 (64)	60 (57)	58 (58)	N/A
3xIF	77 (87)	63 (75)	71 (85)	63 (71)	71 (74)	58 (66)
4xIF	103 (113)	98 (108)	106 (115)	105 (109)	98 (110)	97 (106)
5xIF	118 (126)	108 (120)	119 (127)	116 (123)	111 (124)	98 (116)



MICROLITHIC® DOUBLE-BALANCED I/Q MIXER

MLIQ-1845

Page 8

LO/RF 18 to 45 GHz
IF DC to 20 GHz

Port	Description	DC Interface Schematic
LO	The LO port is DC open to ground and AC matched to 50 Ohms from 18 to 45 GHz. Blocking capacitor is optional.	
RF	The RF port is DC short to ground and AC matched to 50 Ohms from 18 to 45 GHz. Blocking capacitor is optional.	
I/Q	The I/Q ports are DC coupled to the diodes. Blocking capacitor is optional.	

Absolute Maximum Ratings	
Parameter	Maximum Rating
RF DC Current	1 Amp
LO DC Current	1 Amp
IF DC Current ¹	50 mA
RF Power Handling (RF+LO)	+29 dBm at +25°C, derated linearly to +24 dBm at +100°C
IF Power Handling (each IF port, with +24 dBm maximum LO)	+25 dBm at +25°C, derated linearly to +20 dBm at +100°C
Operating Temperature	-55°C to +100°C
Storage Temperature	-65°C to +125°C

¹Application of DC current has been known to damage mixer diodes. Any application of DC current could cause field damage and void the warranty.

DATA SHEET NOTES:

- Mixer Conversion Loss, Rejection, Sideband Suppression, and IP3 plot IF frequency is 60 MHz.
- Mixer Noise Figure typically measures within 0.5 dB of conversion loss for IF frequencies greater than 5 MHz.
- Conversion Loss typically degrades less than 0.5 dB for LO drives 2 dB below the lowest and 3 dB above highest nominal LO drive levels.
- Conversion Loss typically degrades less than 0.5 dB at +100°C and improves less than 0.5 dB at -55°C.
- Unless otherwise specified L diode data taken with +15 dBm LO drive and I diode data taken with +21 dBm LO drive.
- Specifications are subject to change without notice. Contact Marki Microwave for the most recent specifications and data sheets.
- Catalog mixer circuits are continually improved. Configuration control requires custom mixer model numbers and specifications.

Marki Microwave reserves the right to make changes to the product(s) or information contained herein without notice. Marki Microwave makes no warranty, representation, or guarantee regarding the suitability of its products for any particular purpose, nor does Marki Microwave assume any liability whatsoever arising out of the use or application of any product.

© Marki Microwave, Inc.

