



MICROLITHIC™ DOUBLE-BALANCED I/Q MIXER

MLIQ-0218SM

The MLIQ-0218SM is a miniaturized, multi-octave surface-mount 2-18 GHz IQ mixer. It features matched double balanced mixers connected with an integrated LO hybrid and RF power divider. It can be used for either upconversion or downconversion. Applications include communications or radar systems with advanced digital modulation formats and phase modulated signals, test and measurement, or electronic warfare. Image reject or single sideband modulation with excellent suppression is possible with use of an external IF quadrature (90°) hybrid.



Features

- Surface-Mount Package
- CAD Optimized for Superior Isolation and Spurious Response
- Broadband Performance
- Excellent Unit-to-Unit Repeatability
- Fully nonlinear software models available with Marki PDK for Microwave Office
- RoHS Compliant

Mixer Line	Suitable Alternative for Models
I/Q	IQ-0307, IQ-0318, IQ-4509, IQ-0618, IQ-0714, IQ-0917

Electrical Specifications - Specifications guaranteed from -55 to +100°C, measured in a 50Ω system.

Parameter	LO (GHz)	RF (GHz)	IF (GHz)	Min	Typ	Max	Diode Option ¹ LO drive level (dBm)	
Conversion Loss (dB) (Combined IF with Test Hybrid)	2-18		DC-2		8.5	11.5		
			2-3.5		10.5	13.5		
Image Rejection (dB) (Combined IF with Test Hybrid)						See Plots		
I/Q Amplitude Balance (dB)						0.23		
I/Q Quadrature Phase Balance (Degrees)						5		
Isolation (dB) LO-RF LO-IF RF-IF							See Plots	
Input 1 dB Compression (dBm) (Combined IF with Test Hybrid)							+8 +13	L (+11 to +18) I (+18 to +24)
Input Two-Tone Intercept (dBm) (Combined IF with Test Hybrid)							+18 +23	L (+11 to +18) I (+18 to +24)

¹Contact factory for other diode options.

Part Number Options

Please specify diode level and package style by adding to model number.				
Package Style ²		Examples		
		MLIQ-0218LSM-2		
Surface Mount ¹ (RoHS)	SM-2	<u>MLIQ-0218</u> (Model)	<u>L</u> (Diode Option)	<u>SM-2</u> (Package)

¹For port locations and I/O designations, refer to the drawing on page 6 of this document.

²See [MLIQ-0218](#) Data Sheet for connectorized MLIQ-0218SM.

MICROLITHIC™ DOUBLE-BALANCED I/Q MIXER

Page 2

MLIQ-0218SM

LO/RF 2 to 18 GHz
IF DC to 3.5 GHz

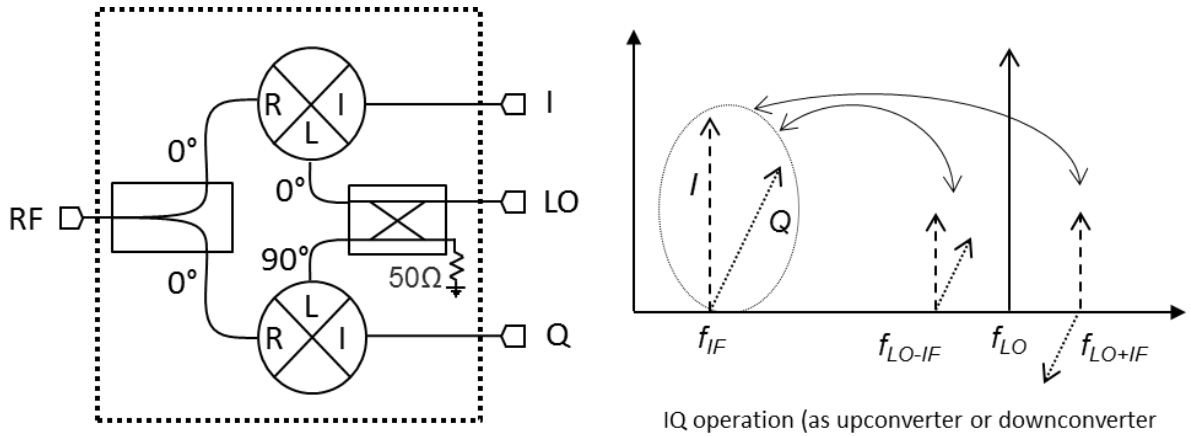

Figure 1a. I/Q Mixer Schematic

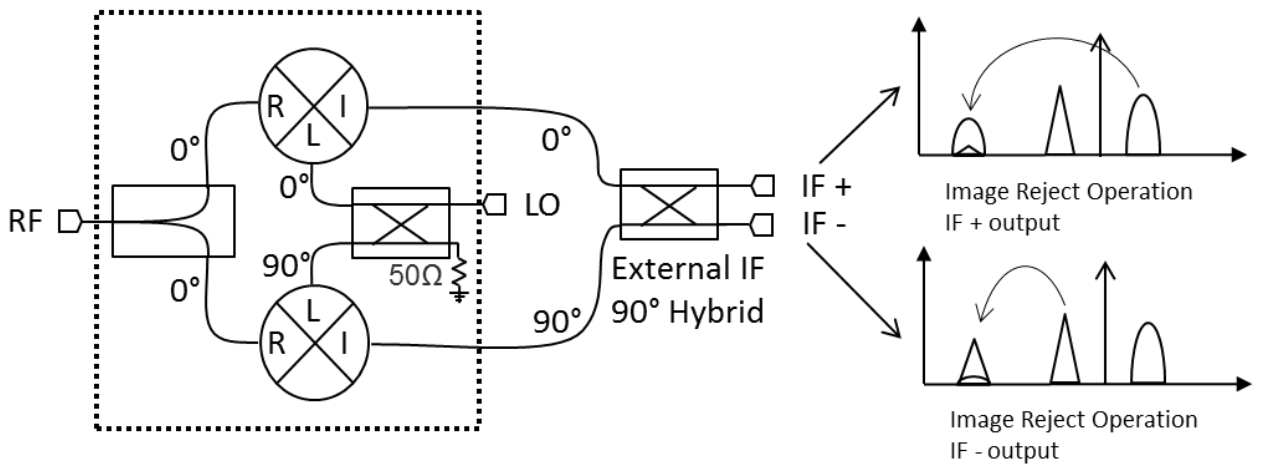

Figure 1b. Image Reject Mixer Schematic

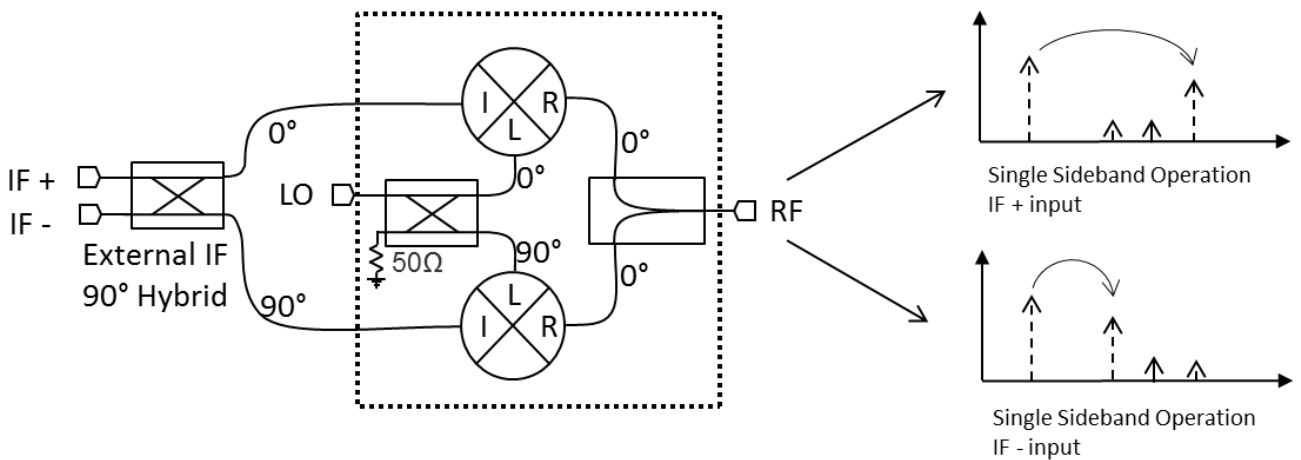

Figure 1c. Single Sideband Mixer Schematic

MICROLITHIC™ DOUBLE-BALANCED I/Q MIXER

MLIQ-0218SM

Page 3

LO/RF 2 to 18 GHz
IF DC to 3.5 GHz

Typical Performance

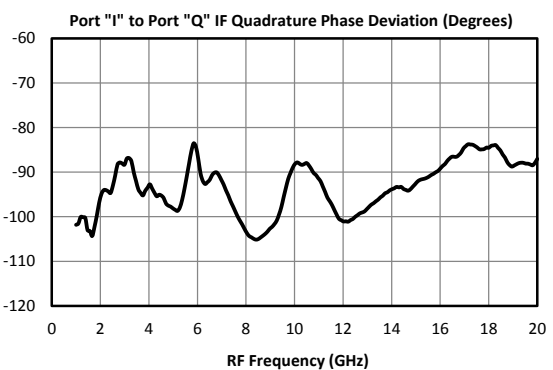
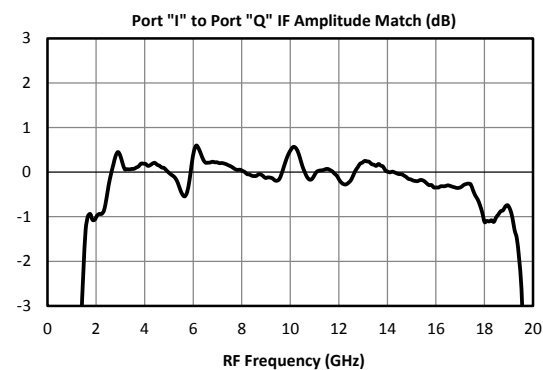
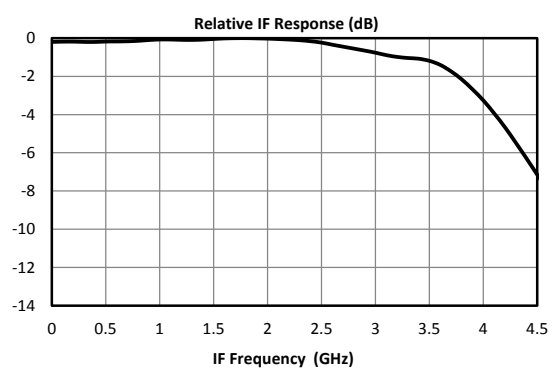
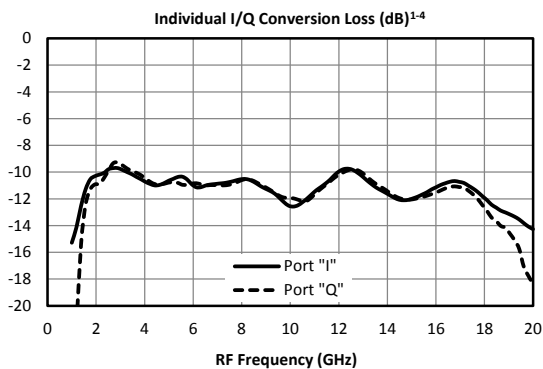
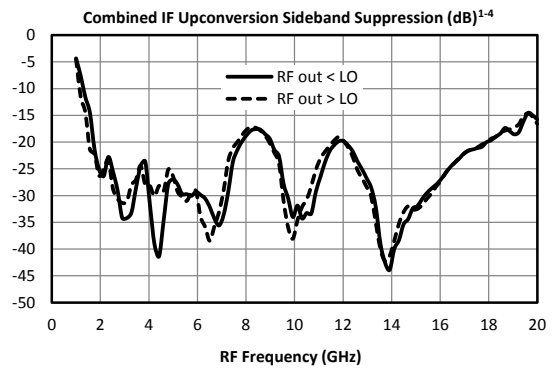
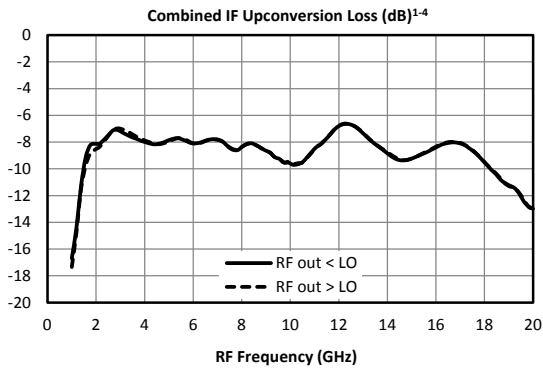
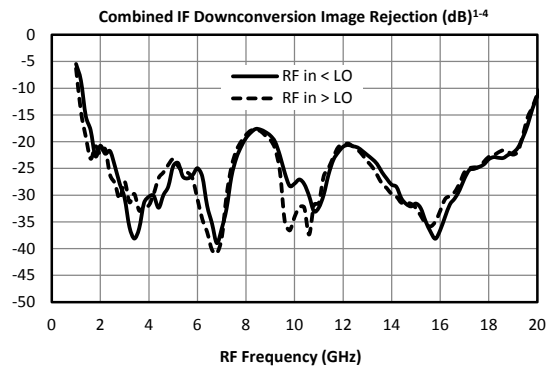
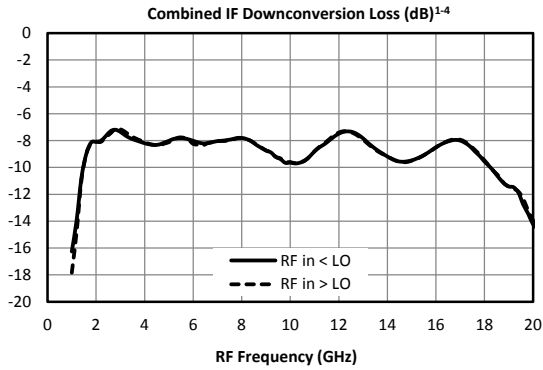

MICROLITHIC™ DOUBLE-BALANCED I/Q MIXER

MLIQ-0218SM

Page 4

LO/RF 2 to 18 GHz
IF DC to 3.5 GHz

Typical Performance (cont.)

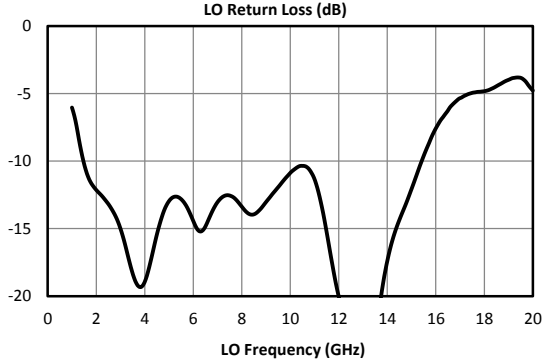
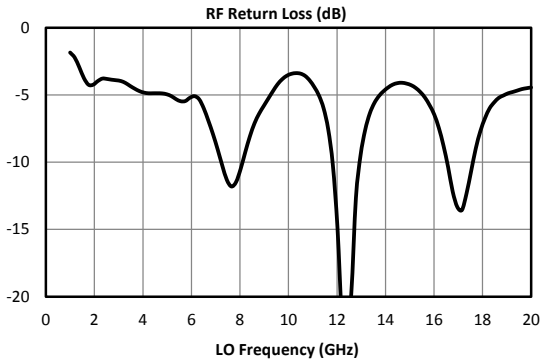
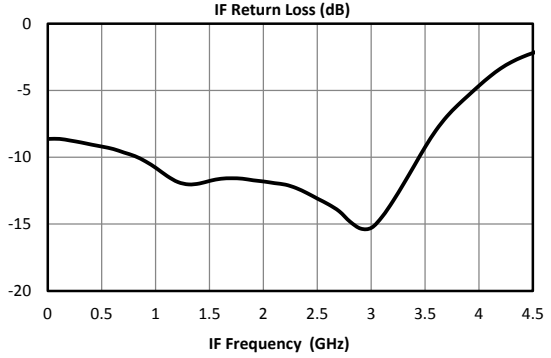
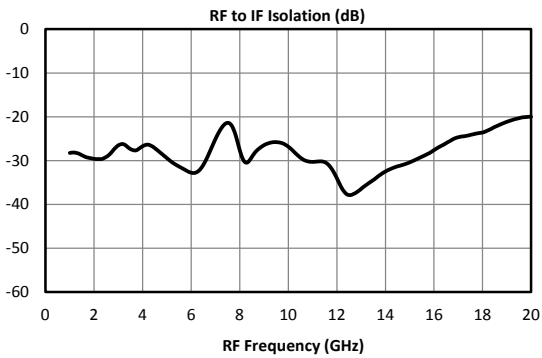
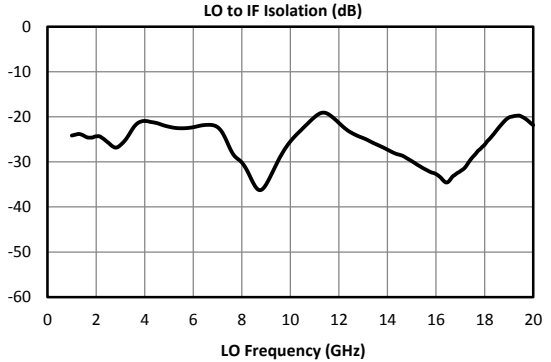
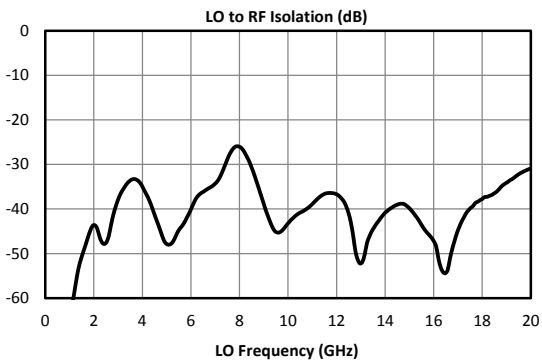
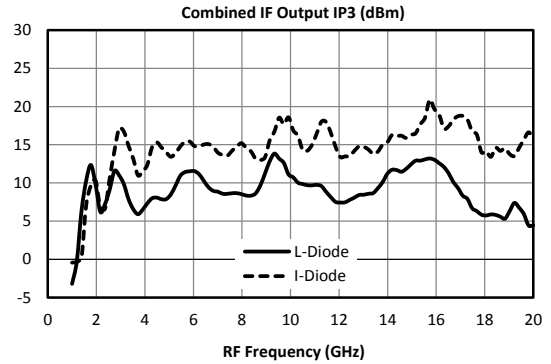
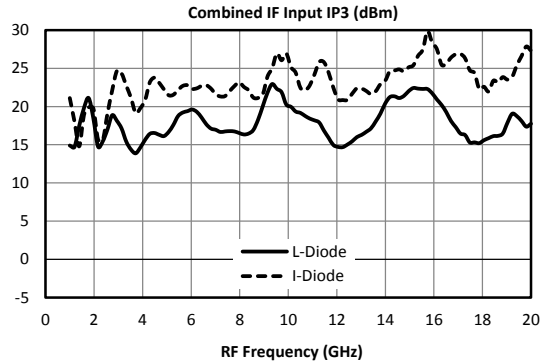

MICROLITHIC™ DOUBLE-BALANCED I/Q MIXER

Page 5

MLIQ-0218SM

LO/RF 2 to 18 GHz
IF DC to 3.5 GHz

Typical Performance

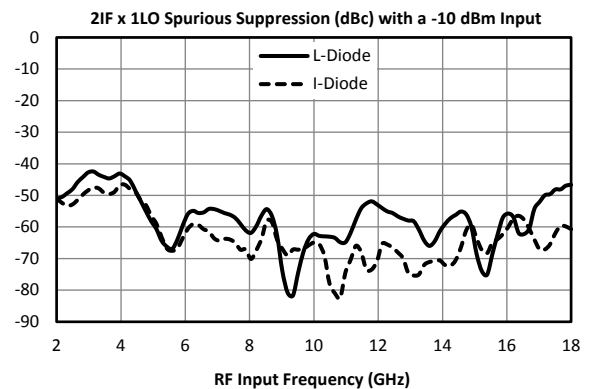
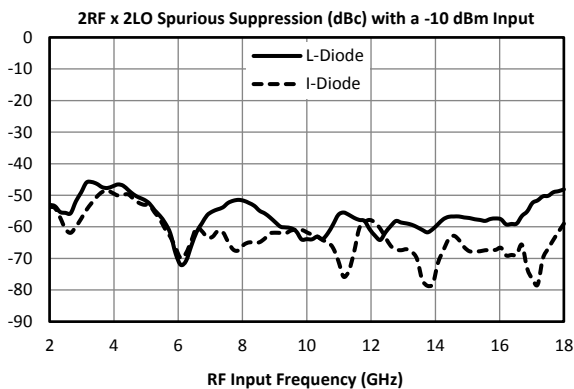
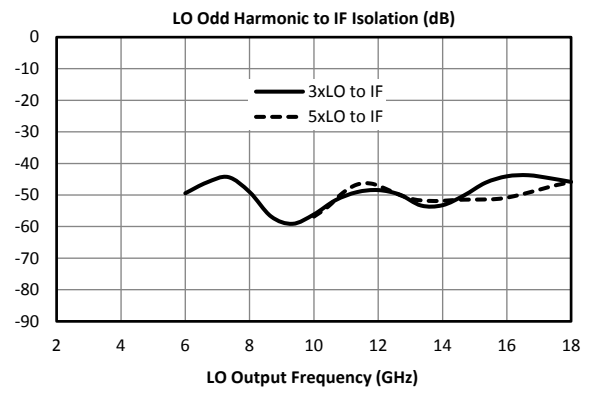
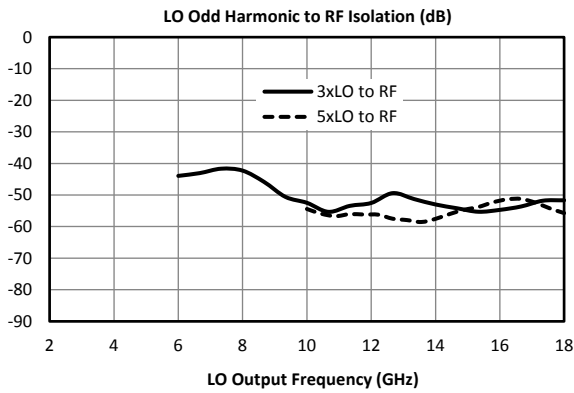
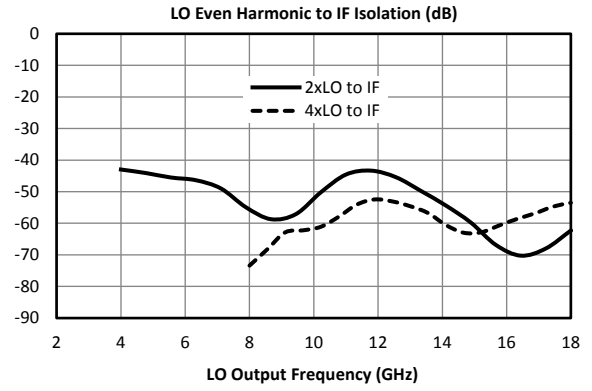
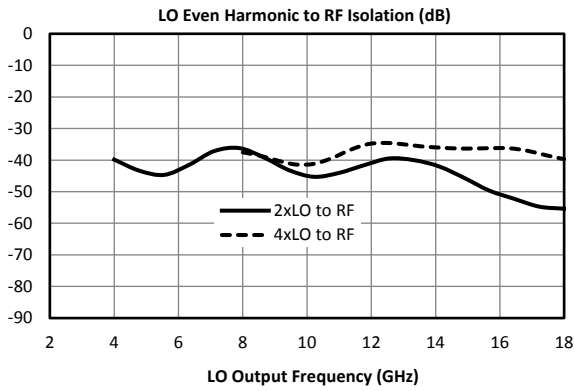

MICROLITHIC™ DOUBLE-BALANCED I/Q MIXER

Page 6

MLIQ-0218SM

LO/RF 2 to 18 GHz
IF DC to 3.5 GHz

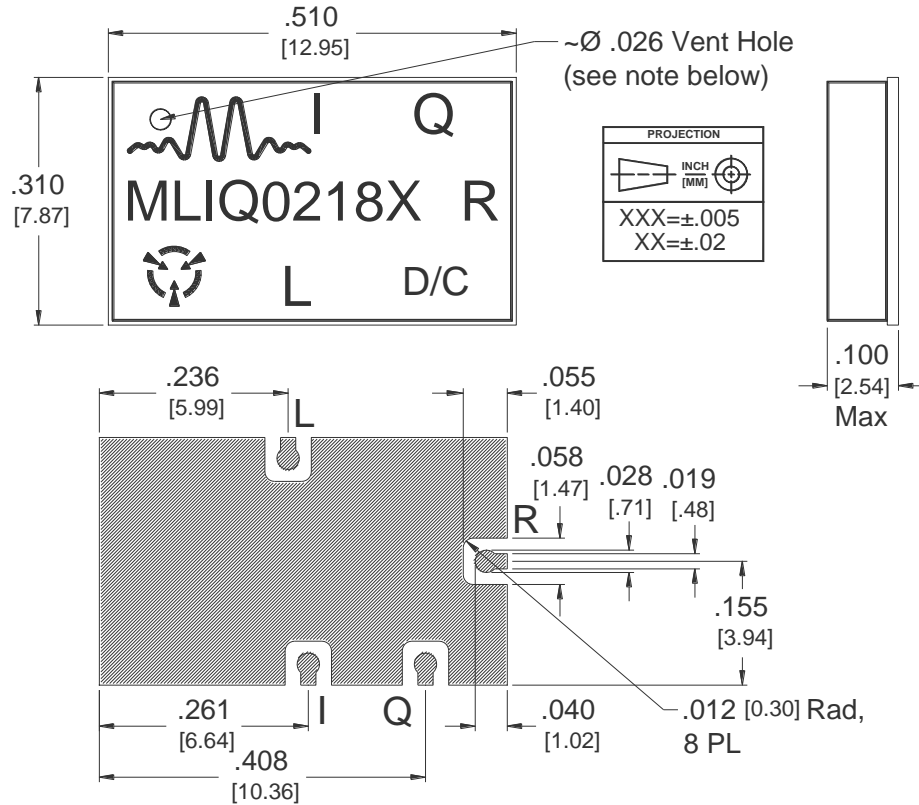

SM Substrate material is .008 thick Rogers 4003.
I/O Connections & Ground Plane Finish is Gold Flash, 5 to 10 μ-inches, over Solderable Electroless Nickel, 100-200 μ-inches, over Cu.
MLIQ-0218XSM-2 lid is vented. Baking in a vacuum oven at 120° to 140 C° for one hour after any aqueous wash is recommended.

Figure 2a. Outline Drawing – SM-2

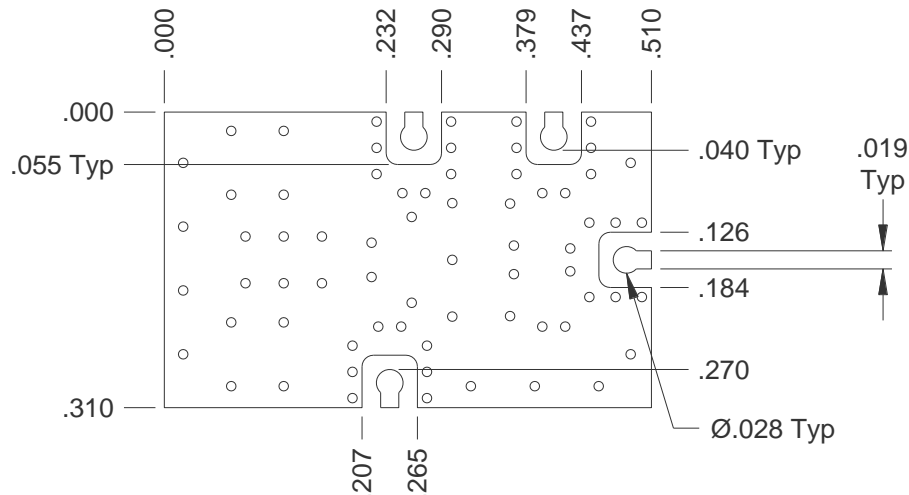

Figure 2b. SM-2 Landing Pattern

[Click here for a DXF of the above layout.](#)

[Click here for leaded solder reflow.](#) [Click here for lead-free solder reflow.](#)



MICROLITHIC™ DOUBLE-BALANCED I/Q MIXER

MLIQ-0218SM

Page 7

**LO/RF 2 to 18 GHz
IF DC to 3.5 GHz**

Downconversion Spurious Suppression

Spurious data is taken by selecting RF and LO frequencies ($\pm mLO \pm nRF$) within the RF/LO bands, to create a spurious output within the IF band. The mixer is swept across the full spurious band and the mean is calculated. The numbers shown in the table below are for a -10 dBm RF input. Spurious suppression is scaled for different RF power levels by (n-1), where “n” is the RF spur order. For example, the 2RFx2LO spur for an L-Diode is typically 57 dBc with a -10 dBm input, so a -20 dBm RF input creates a spur that is (2-1) x (-10 dB) dB lower, or 67 dBc.

Typical Downconversion Spurious Suppression (dBc): L-diode (I-Diode) ⁵

-10 dBm RF Input	0xLO	1xLO	2xLO	3xLO	4xLO	5xLO
1xRF	18 (19)	Reference	20 (20)	9 (9)	31 (32)	18 (18)
2xRF	67 (70)	51 (57)	57 (63)	51 (56)	55 (56)	48 (51)
3xRF	82 (91)	60 (74)	75 (85)	66 (76)	72 (82)	66 (74)
4xRF	113 (120)	97 (108)	98 (114)	100 (111)	101 (110)	97 (107)
5xRF	120 (132)	105 (124)	113 (128)	111 (128)	117 (128)	115 (127)

Upconversion Spurious Suppression

Spurious data is taken by mixing an input within the IF band, with LO frequencies ($\pm mLO \pm nIF$), to create a spurious output within the RF output band. The mixer is swept across the full spurious output band and the mean is calculated. The numbers shown in the table below are for a -10 dBm individual IF input, with the unused port terminated in 50 ohms. Spurious suppression is scaled for different IF input power levels by (n-1), where “n” is the IF spur order. For example, the 2IFx1LO spur for an L-Diode is typically 57 dBc with a -10 dBm input, so a -20 dBm IF input creates a spur that is (2-1) x (-10 dB) dB lower, or 67 dBc.

Typical Upconversion Spurious Suppression (dBc): L-diode (I-Diode) ⁵

-10 dBm IF Input	0xLO	1xLO	2xLO	3xLO	4xLO	5xLO
1xIF	17 (17)	Reference	25 (25)	10 (10)	29 (29)	17 (17)
2xIF	58 (63)	57 (60)	47 (50)	54 (59)	38 (45)	48 (60)
3xIF	76 (90)	61 (73)	64 (73)	54 (63)	62 (72)	50 (56)
4xIF	106 (112)	97 (106)	86 (93)	88 (98)	75 (84)	84 (92)
5xIF	115 (128)	100 (118)	106 (115)	94 (103)	102 (112)	90 (96)



MICROLITHIC™ DOUBLE-BALANCED I/Q MIXER

Page 8

MLIQ-0218SM

**LO/RF 2 to 18 GHz
IF DC to 3.5 GHz**

Port	Description	DC Interface Schematic
LO	The LO port is DC short to ground and AC matched to 50 Ohms from 2 to 18 GHz. Blocking capacitor is optional.	
RF	The RF port is DC short to ground and AC matched to 50 Ohms from 2 to 18 GHz. Blocking capacitor is optional.	
I/Q	The I/Q ports are DC coupled to the diodes. Blocking capacitor is optional.	

Absolute Maximum Ratings	
Parameter	Maximum Rating
RF DC Current	1 Amp
LO DC Current	1 Amp
IF DC Current ¹	50 mA
RF Power Handling (RF+LO)	+29 dBm at +25°C, derated linearly to +24 dBm at +100°C
IF Power Handling (each IF port, with +24 dBm maximum LO)	+25 dBm at +25°C, derated linearly to +20 dBm at +100°C
Operating Temperature	-55°C to +100°C
Storage Temperature	-65°C to +125°C

¹Application of DC current has been known to damage mixer diodes. Any application of DC current >50 mA could cause field damage and void the warranty.

DATA SHEET NOTES:

- Mixer Conversion Loss, Rejection, Sideband Suppression, and IP3 plot IF frequency is 60 MHz.
- Mixer Noise Figure typically measures within 0.5 dB of conversion loss for IF frequencies greater than 5 MHz.
- Conversion Loss typically degrades less than 0.5 dB for LO drives 2 dB below the lowest and 3 dB above highest nominal LO drive levels.
- Conversion Loss typically degrades less than 0.5 dB at +100°C and improves less than 0.5 dB at -55°C.
- Unless otherwise specified L diode data taken with +15 dBm LO drive and I diode data taken with +21 dBm LO drive.
- Specifications are subject to change without notice. Contact Marki Microwave for the most recent specifications and data sheets.
- Catalog mixer circuits are continually improved. Configuration control requires custom mixer model numbers and specifications.

Marki Microwave reserves the right to make changes to the product(s) or information contained herein without notice. Marki Microwave makes no warranty, representation, or guarantee regarding the suitability of its products for any particular purpose, nor does Marki Microwave assume any liability whatsoever arising out of the use or application of any product.

© Marki Microwave, Inc.



215 Vineyard Court, Morgan Hill, CA 95037 | Ph: 408.778.4200 | Fax 408.778.4300 | info@markimicrowave.com
www.markimicrowave.com