



## MICROLITHIC™ DOUBLE-BALANCED I/Q MIXER

## MLIQ-0218

The MLIQ-0218 is a miniaturized, multi-octave 2-18 GHz IQ mixer. It features matched double balanced mixers connected with an integrated LO hybrid and RF power divider. It can be used for either up or downconversion. Applications include communications or radar systems with advanced digital modulation formats and phase modulated signals, test and measurement, or electronic warfare. Image reject or single sideband modulation with excellent suppression is possible with use of an external IF quadrature (90°) hybrid.



### Features

- Compact Chip Style Package (0.370" x 0.160"x0.010")
- CAD Optimized for Superior Isolation and Spurious Response
- Broadband Performance
- Excellent Unit-to-Unit Repeatability
- Fully nonlinear software models available with Marki PDK for Microwave Office
- RoHS Compliant

Mixer Line	Suitable Alternative for Models
I/Q	IQ-0307, IQ-0318, IQ-4509, IQ-0618, IQ-0714, IQ-0917

**Electrical Specifications** - Specifications guaranteed from -55 to +100°C, measured in a 50Ω system.

Parameter	LO (GHz)	RF (GHz)	IF (GHz)	Min	Typ	Max	Diode Option <sup>1</sup> LO drive level (dBm)	
Conversion Loss (dB) (Combined IF with Test Hybrid)	2-18		DC-2		8.5	11.5		
			2-3.5		10.5	13.5		
Image Rejection (dB) (Combined IF with Test Hybrid)						See Plots		
I/Q Amplitude Balance (dB)						0.21		
I/Q Quadrature Phase Balance (Degrees)						5		
Isolation (dB) LO-RF LO-IF RF-IF							See Plots	
Input 1 dB Compression (dBm) (Combined IF with Test Hybrid)							+8 +13	L (+11 to +18) I (+18 to +24)
Input Two-Tone Intercept (dBm) (Combined IF with Test Hybrid)							+17 +23	L (+11 to +18) I (+18 to +24)

<sup>1</sup>Contact factory for other diode options.

### Part Number Options

Please specify diode level and package style by adding to model number.			
Package Styles		Examples	
Connectorized <sup>2,3</sup>	(no suffix)	MLIQ-0218LCH-2, MLIQ-0218L	
Chip <sup>1,3</sup> (RoHS)	CH-2	<u>MLIQ-0218</u> (Model)	<u>L</u> (Diode Option) <u>CH-2</u> (Package)

<sup>1</sup> Chip package connects to external circuit through wire bondable gold pads. See page 6 for plating details.

<sup>2</sup> Connectorized package consists of chip package wire bonded to a substrate, equivalent to an evaluation board.

<sup>3</sup> Note: For port locations and I/O designations, refer to the drawing on page 6 of this document.

# MICROLITHIC™ DOUBLE-BALANCED I/Q MIXER

# MLIQ-0218

Page 2

LO/RF 2 to 18 GHz  
IF DC to 3.5 GHz

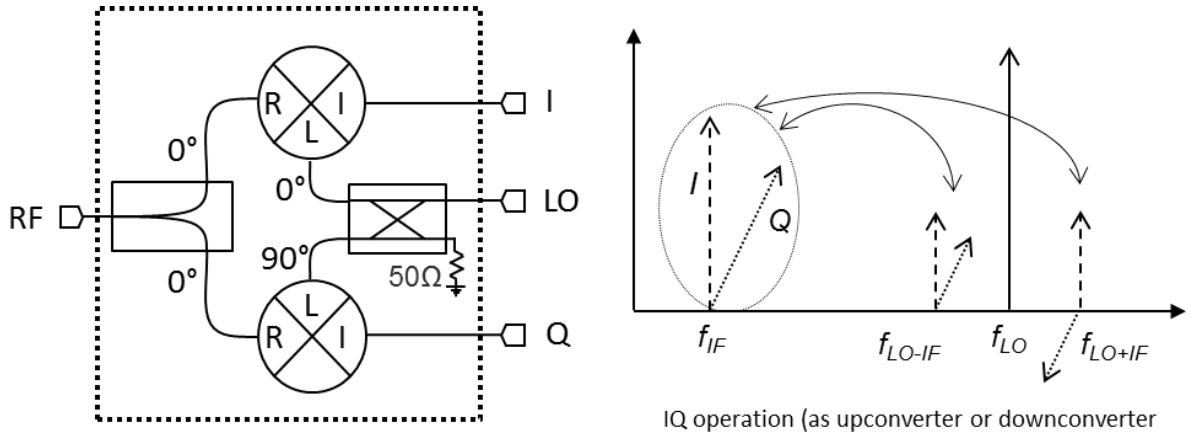

Figure 1a. I/Q Mixer Schematic

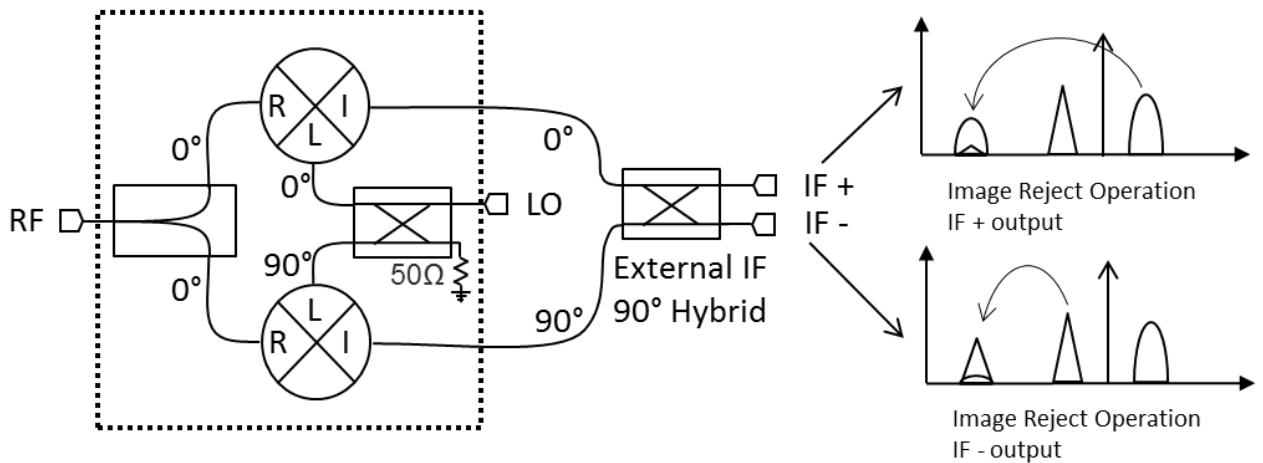

Figure 1b. Image Reject Mixer Schematic

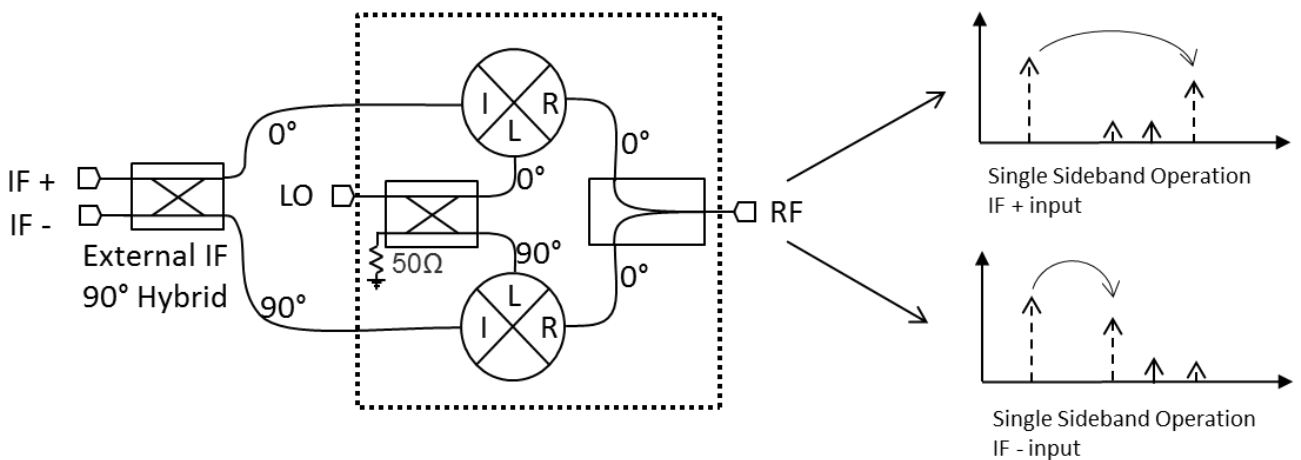

Figure 1c. Single Sideband Mixer Schematic

# MICROLITHIC™ DOUBLE-BALANCED I/Q MIXER

# MLIQ-0218

Page 3

LO/RF 2 to 18 GHz  
IF DC to 3.5 GHz

### Typical Performance

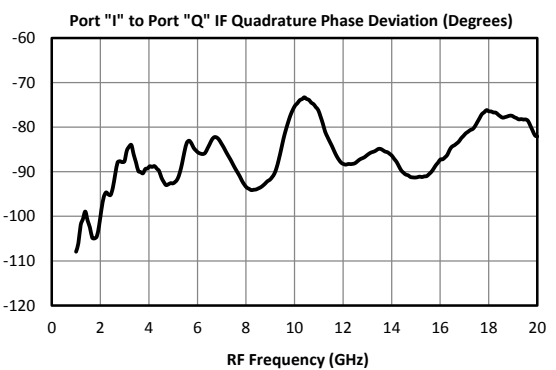
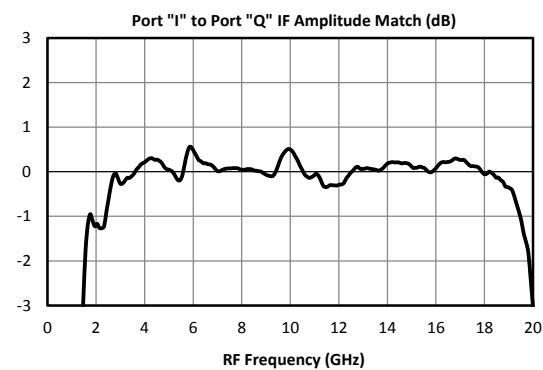
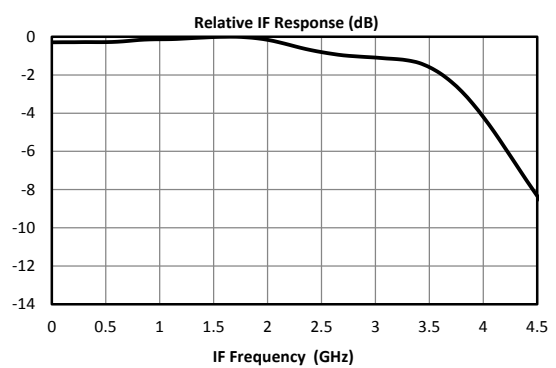
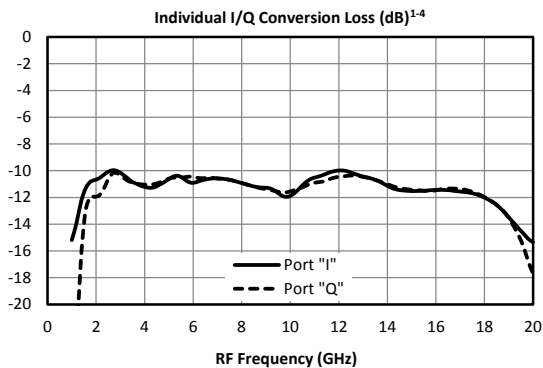
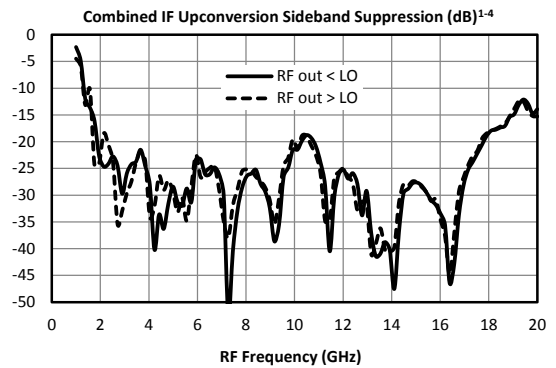
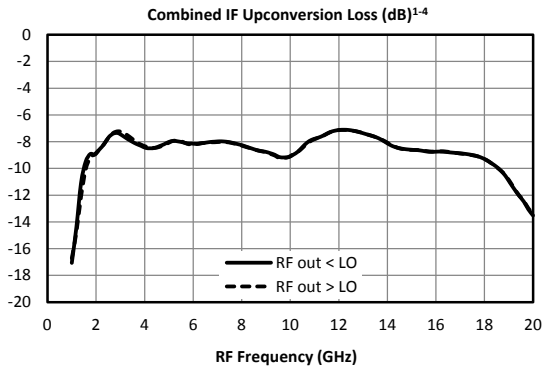
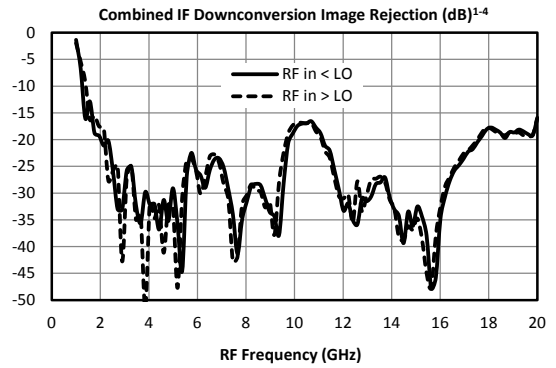
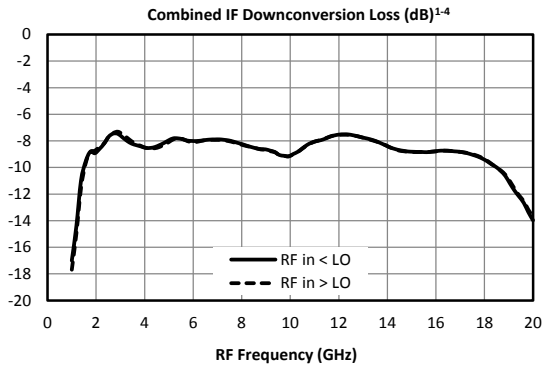

**MICROLITHIC™ DOUBLE-BALANCED I/Q MIXER**

**MLIQ-0218**

Page 4

LO/RF 2 to 18 GHz  
IF DC to 3.5 GHz

Typical Performance (cont.)

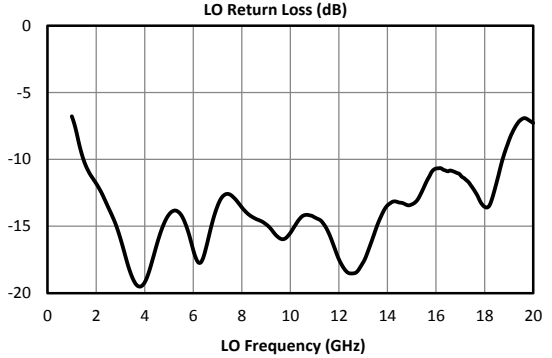
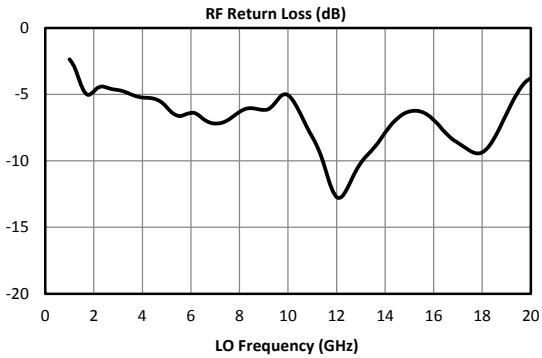
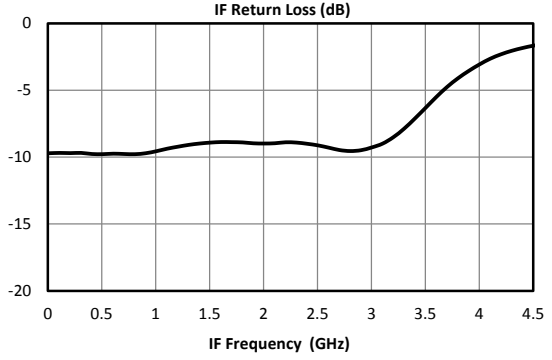
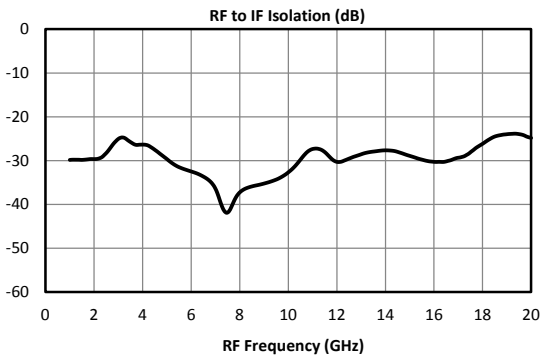
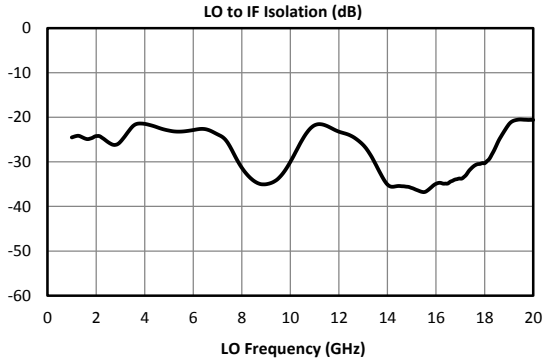
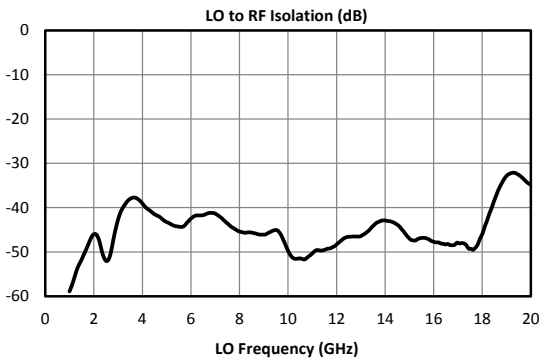
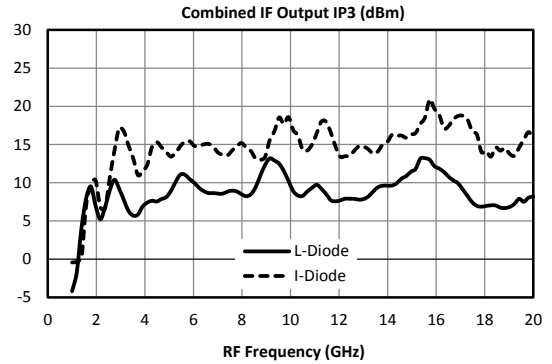
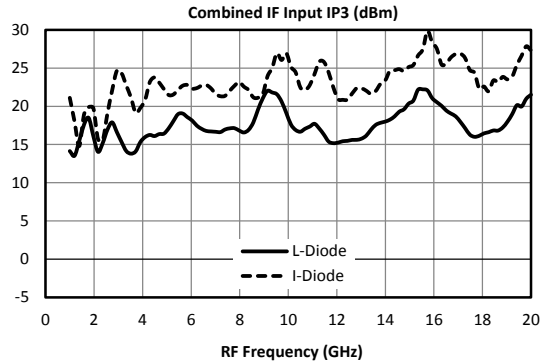

# MICROLITHIC™ DOUBLE-BALANCED I/Q MIXER

# MLIQ-0218

Page 5

LO/Rf 2 to 18 GHz  
IF DC to 3.5 GHz

## Typical Performance

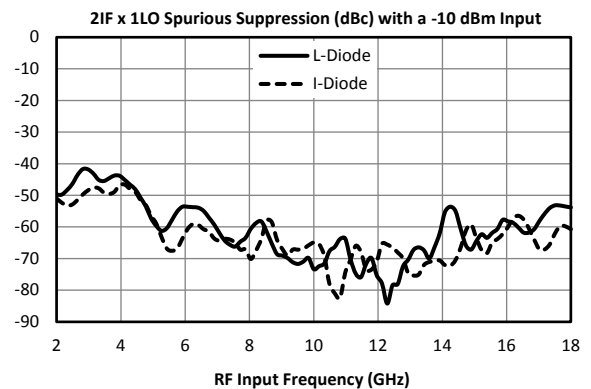
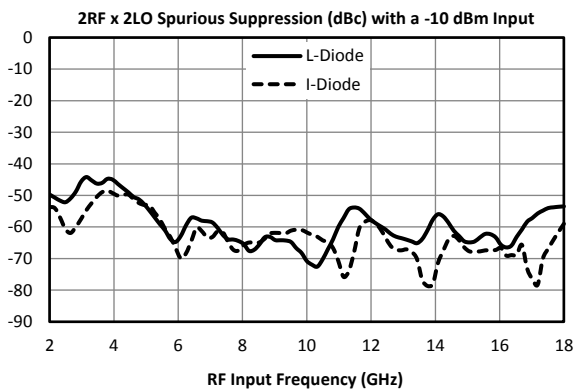
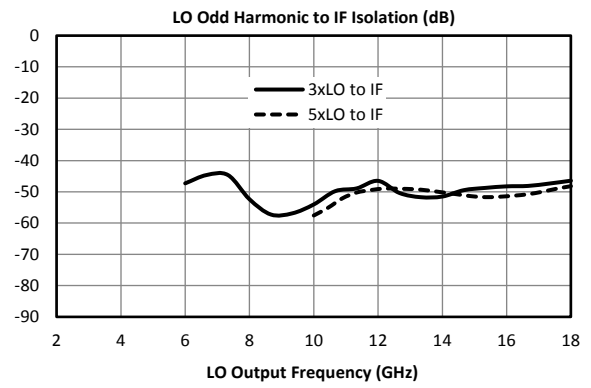
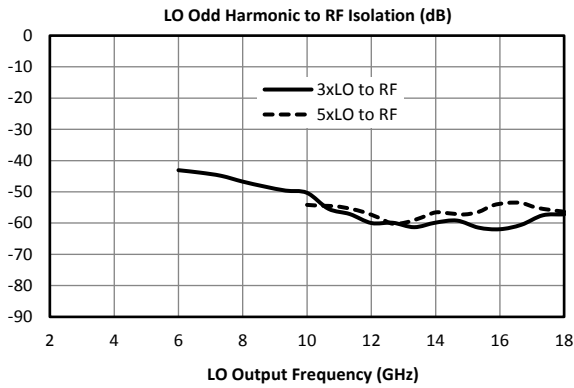
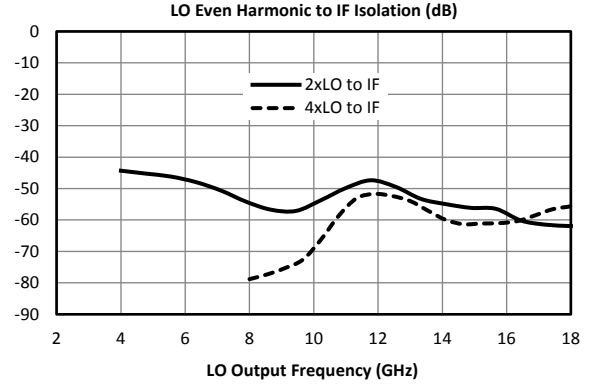
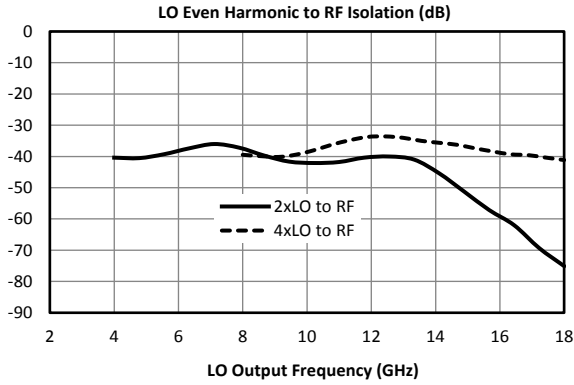

# MICROLITHIC™ DOUBLE-BALANCED I/Q MIXER

# MLIQ-0218

Page 6

LO/RF 2 to 18 GHz  
IF DC to 3.5 GHz

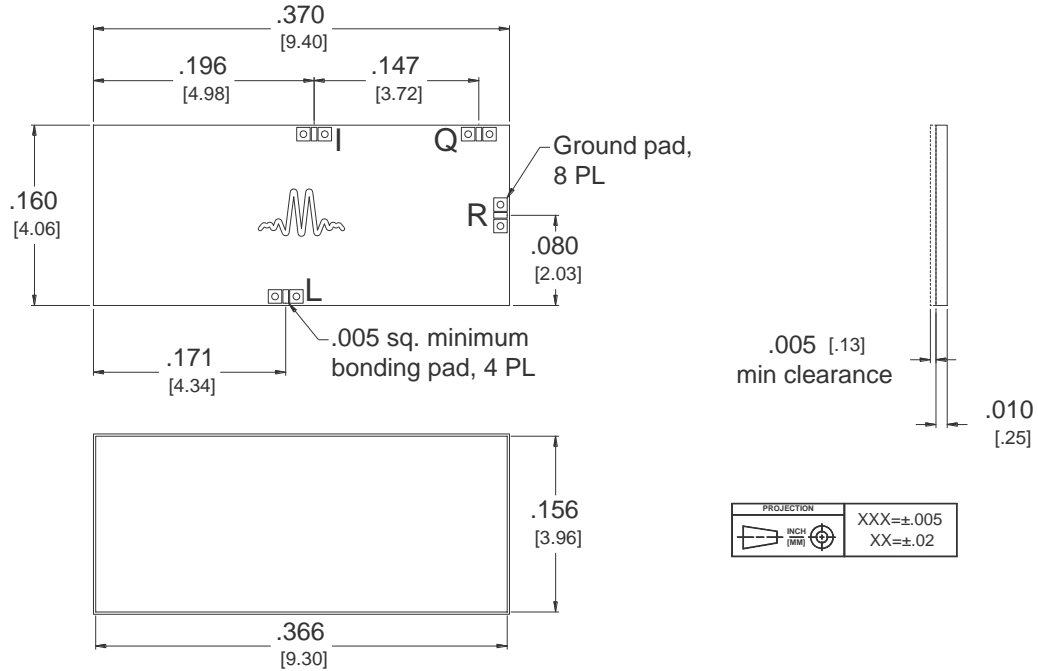
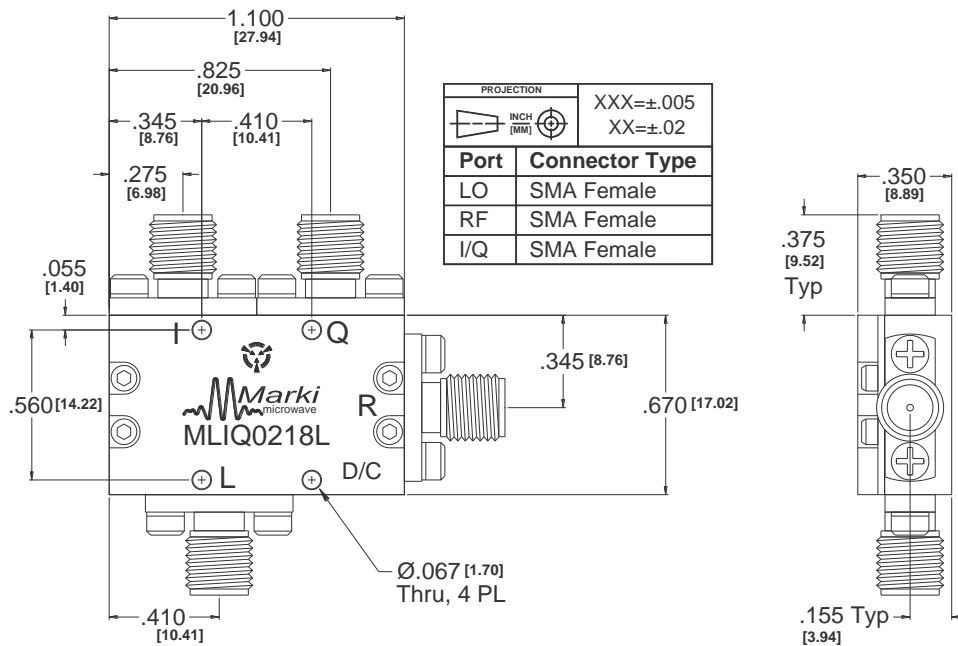

**Figure 2a. Outline Drawing – CH-2**

\*CH Substrate material is .010 thick Ceramic.

I/O traces and ground plane finish is 2.5 microns Au over .05 microns WTi.

Wire Bonding - Ball or wedge bond with 0.025 mm (1 mil) diameter pure gold wire. Thermosonic wirebonding with a nominal stage temperature of 150 °C and a ball bonding force of 40 to 50 grams or wedge bonding force of 18 to 22 grams is recommended. Use the minimum level of ultrasonic energy to achieve reliable wirebonds. Wirebonds should be started on the chip and terminated on the package or substrate. All bonds should be as short as possible <0.31 mm (12 mils).



**Figure 2b. Outline Drawing - Packaged**



**MICROLITHIC™ DOUBLE-BALANCED I/Q MIXER**

**MLIQ-0218**

Page 7

**LO/RF 2 to 18 GHz  
IF DC to 3.5 GHz**

**Downconversion Spurious Suppression**

Spurious data is taken by selecting RF and LO frequencies ( $\pm mLO \pm nRF$ ) within the RF/LO bands, to create a spurious output within the IF band. The mixer is swept across the full spurious band and the mean is calculated. The numbers shown in the table below are for a -10 dBm RF input. Spurious suppression is scaled for different RF power levels by (n-1), where “n” is the RF spur order. For example, the 2RFx2LO spur for an L-Diode is typically 60 dBc with a -10 dBm input, so a -20 dBm RF input creates a spur that is (2-1) x (-10 dB) dB lower, or 70 dBc.

**Typical Downconversion Spurious Suppression (dBc): L-diode (I-Diode) <sup>5</sup>**

<b>-10 dBm RF Input</b>	0xLO	1xLO	2xLO	3xLO	4xLO	5xLO
1xRF	18 (19)	Reference	19 (19)	9 (9)	30 (32)	18 (17)
2xRF	69 (70)	52 (57)	60 (63)	52 (56)	56 (56)	48 (51)
3xRF	81 (91)	60 (74)	74 (85)	66 (76)	71 (82)	68 (74)
4xRF	112 (120)	100 (108)	100 (114)	100 (111)	101 (110)	98 (107)
5xRF	127 (132)	106 (124)	111 (128)	113 (128)	117 (128)	115 (127)

**Upconversion Spurious Suppression**

Spurious data is taken by mixing an input within the IF band, with LO frequencies ( $\pm mLO \pm nIF$ ), to create a spurious output within the RF output band. The mixer is swept across the full spurious output band and the mean is calculated. The numbers shown in the table below are for a -10 dBm individual IF input, with the unused port terminated in 50 ohms. Spurious suppression is scaled for different IF input power levels by (n-1), where “n” is the IF spur order. For example, the 2IFx1LO spur for an L-Diode is typically 61 dBc with a -10 dBm input, so a -20 dBm IF input creates a spur that is (2-1) x (-10 dB) dB lower, or 71 dBc.

**Typical Upconversion Spurious Suppression (dBc): L-diode (I-Diode) <sup>5</sup>**

<b>-10 dBm IF Input</b>	0xLO	1xLO	2xLO	3xLO	4xLO	5xLO
1xIF	16 (16)	Reference	23 (23)	9 (9)	28 (29)	18 (17)
2xIF	60 (63)	61 (63)	48 (50)	53 (59)	40 (45)	48 (60)
3xIF	72 (90)	62 (73)	63 (73)	54 (63)	63 (72)	50 (56)
4xIF	110 (112)	100 (106)	88 (93)	88 (98)	77 (84)	84 (92)
5xIF	119 (128)	102 (118)	106 (115)	94 (103)	102 (112)	90 (96)



**MICROLITHIC™ DOUBLE-BALANCED I/Q MIXER**

**MLIQ-0218**

Page 8

LO/RF 2 to 18 GHz  
IF DC to 3.5 GHz

Port	Description	DC Interface Schematic
LO	The LO port is DC short to ground and AC matched to 50 Ohms from 2 to 18 GHz. Blocking capacitor is optional.	
RF	The RF port is DC short to ground and AC matched to 50 Ohms from 2 to 18 GHz. Blocking capacitor is optional.	
I/Q	The I/Q ports are DC coupled to the diodes. Blocking capacitor is optional.	

Absolute Maximum Ratings	
Parameter	Maximum Rating
RF DC Current	1 Amp
LO DC Current	1 Amp
IF DC Current <sup>1</sup>	50 mA
RF Power Handling (RF+LO)	+29 dBm at +25°C, derated linearly to +24 dBm at +100°C
IF Power Handling (each IF port, with +24 dBm maximum LO)	+25 dBm at +25°C, derated linearly to +20 dBm at +100°C
Operating Temperature	-55°C to +100°C
Storage Temperature	-65°C to +125°C

<sup>1</sup>Application of DC current has been known to damage mixer diodes. Any application of DC current could cause field damage and void the warranty.

DATA SHEET NOTES:

- Mixer Conversion Loss, Rejection, Sideband Suppression, and IP3 plot IF frequency is 60 MHz.
- Mixer Noise Figure typically measures within 0.5 dB of conversion loss for IF frequencies greater than 5 MHz.
- Conversion Loss typically degrades less than 0.5 dB for LO drives 2 dB below the lowest and 3 dB above highest nominal LO drive levels.
- Conversion Loss typically degrades less than 0.5 dB at +100°C and improves less than 0.5 dB at -55°C.
- Unless otherwise specified L diode data taken with +15 dBm LO drive and I diode data taken with +21 dBm LO drive.
- Specifications are subject to change without notice. Contact Marki Microwave for the most recent specifications and data sheets.
- Catalog mixer circuits are continually improved. Configuration control requires custom mixer model numbers and specifications.

*Marki Microwave reserves the right to make changes to the product(s) or information contained herein without notice. Marki Microwave makes no warranty, representation, or guarantee regarding the suitability of its products for any particular purpose, nor does Marki Microwave assume any liability whatsoever arising out of the use or application of any product.*

© Marki Microwave, Inc.



215 Vineyard Court, Morgan Hill, CA 95037 | Ph: 408.778.4200 | Fax 408.778.4300 | [info@markimicrowave.com](mailto:info@markimicrowave.com)  
[www.markimicrowave.com](http://www.markimicrowave.com)