

Passive MMIC 21-27GHz Bandpass Filter

MFB-2400

1 Device Overview

1.1 General Description

The MFB-2400 is a passive MMIC bandpass filter. It is a low loss integrated filter that passes most K- band frequencies (21-27GHz). Passive GaAs MMIC technology allows production of smaller filter constructions that replace larger form factor circuit board constructions. Tight fabrication tolerances allow for less unit to unit variation than traditional filter technologies. The MFB-2400 is available as a wire bondable chip. Low unit to unit variation allow for accurate simulations using the provided S2P file taken from measured production units.

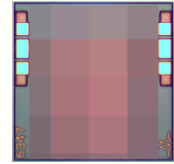

Bare Die

1.2 Features

- Designed for K-band and SATCOM Applications
- Typical Insertion Loss 1.5dB at Center Frequency
- Excellent Return Loss
- High Stop Band Suppression
- Wide Stop Band
- S2P data: [MFB-2400.zip](#)

1.3 Functional Block Diagram



1.4 Part Ordering Options¹

Part Number	Description	Package	Green Status	Product Lifecycle	Export Classification
MFB-2400CH	Wire bondable die	CH	RoHS	Active	EAR99

¹ Refer to our [website](#) for a list of definitions for terminology presented in this table.

Table of Contents

1	Device Overview	1	3.3	Electrical Specifications.....	4
1.1	General Description	1	3.4	Typical Performance Plots.....	5
1.2	Features.....	1	3.4.1	Insertion Loss.....	5
1.3	Functional Block Diagram.....	1	3.4.2	Return Loss & Group Delay.....	5
1.4	Part Ordering Options	1	4	Die Mounting Recommendations	6
2	Port Configurations and Functions	3	4.1	Mounting and Bonding Recommendations	6
2.1	Port Diagram	3	4.2	Bonding Diagram	6
2.2	Port Functions	3	4.3	Handling Precautions.....	7
3	Specifications	4	5	Mechanical Data.....	7
3.1	Absolute Maximum Ratings	4	5.1	CH Package Outline Drawing.....	7
3.2	Package Information.....	4			

Revision History

Revision Code	Revision Date	Comment
-	January 2018	Datasheet Initial Release

2 Port Configurations and Functions

2.1 Port Diagram

A top-down view of the MFB-2400CH package outline drawing is shown below. The MMIC bandpass filters are symmetrical allowing Port 1 or Port 2 to be used as the input.

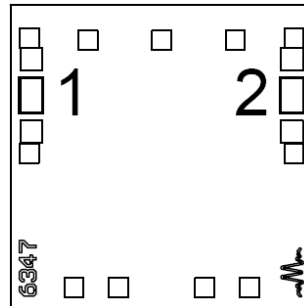

2.2 Port Functions

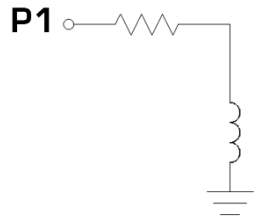
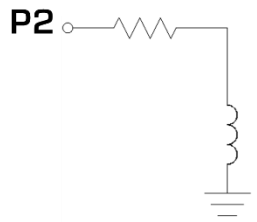
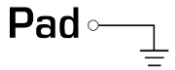
Port	Function	Description	Equivalent Circuit
Port 1	Input/Output	Port 1 is DC connected to ground through a resistor. DC block is required if voltage present.	
Port 2	Input/Output	Port 2 is DC connected to ground through a resistor. DC block is required if voltage present.	
Pad	Ground	CH package ground path is provided through the substrate and ground bond pads.	

3 Specifications

3.1 Absolute Maximum Ratings

The Absolute Maximum Ratings indicate limits beyond which damage may occur to the device. If these limits are exceeded, the device may be inoperable or have a reduced lifetime.

Parameter	Maximum Rating	Units
Port 1 DC Current	40	mA
Port 2 DC Current	40	mA
Power Handling, at any Port	+30	dBm
Operating Temperature	-55 to +100	°C
Storage Temperature	-65 to +125	°C

3.2 Package Information

Parameter	Details	Rating
ESD	Human Body Model (HBM), per MIL-STD-750, Method 1020	TBD

3.3 Electrical Specifications²

The electrical specifications apply at $T_A=+25^\circ\text{C}$ in a 50Ω system.

Min and Max limits are guaranteed at $T_A=+25^\circ\text{C}$. All bare die are 100% DC tested and visually inspected.

Parameter	Frequency (GHz)	Min	Typ.	Max
Center Frequency, f_c (GHz)			24	
Passband (GHz)			21-27	
Insertion Loss @ f_c (dB)			1.5	3
Passband Return Loss (dB)	21-27		15	
Stopband Suppression (dB)	3.4 11.7, 30.0	40 25	50 30	
Impedance (Ω)			50	

² Equalizer is symmetrical. Reverse measurement is equivalent to forward measurement.

3.4 Typical Performance Plots

3.4.1 Insertion Loss

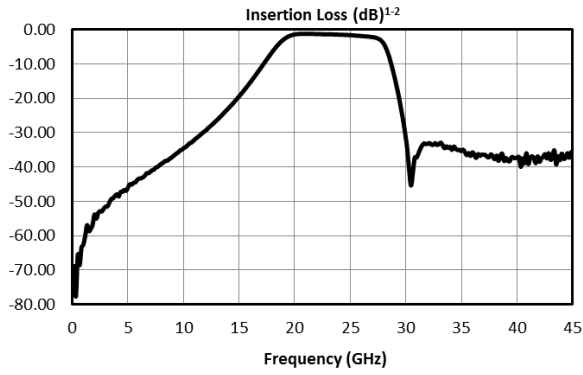

3.4.2 Return Loss & Group Delay³

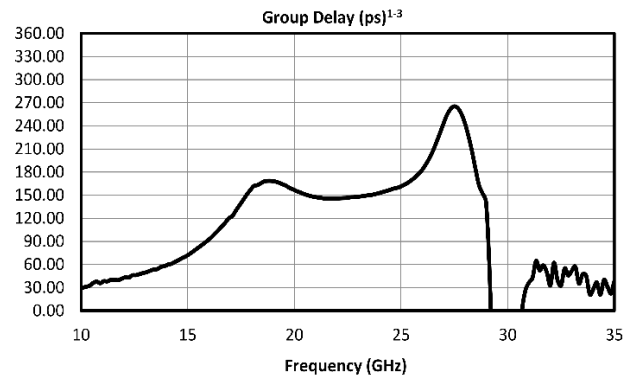
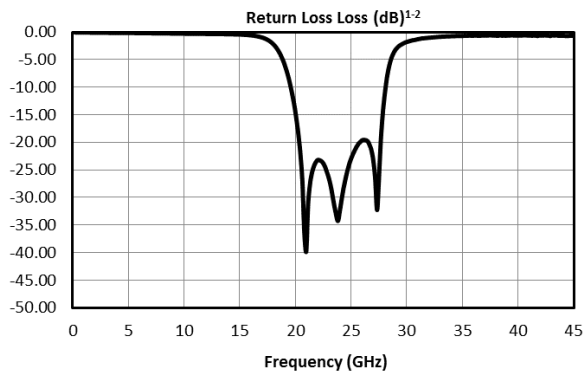

¹ Filter is symmetrical. Reverse measurement is equivalent to forward measurement.

² All measured data is taken and simulations assume 50 Ω probes on chip.

³ Group delay calculated using wrapped phase response.

4 Die Mounting Recommendations

4.1 Mounting and Bonding Recommendations

Marki MMICs should be attached directly to a ground plane with conductive epoxy. The ground plane electrical impedance should be as low as practically possible. This will prevent resonances and permit the best possible electrical performance. Datasheet performance is only guaranteed in an environment with a low electrical impedance ground.

Mounting - To epoxy the chip, apply a minimum amount of conductive epoxy to the mounting surface so that a thin epoxy fillet is observed around the perimeter of the chip. Cure epoxy according to manufacturer instructions.

Wire Bonding - Ball or wedge bond with 0.025 mm (1 mil) diameter pure gold wire. Thermosonic wirebonding with a nominal stage temperature of 150 °C and a ball bonding force of 40 to 50 grams or wedge bonding force of 18 to 22 grams is recommended. Use the minimum level of ultrasonic energy to achieve reliable wirebonds. Wirebonds should be started on the chip and terminated on the package or substrate. All bonds should be as short as possible <0.31 mm (12 mils).

Circuit Considerations – 50 Ω transmission lines should be used for all high frequency connections in and out of the chip. Wirebonds should be kept as short as possible, with multiple wirebonds recommended for higher frequency connections to reduce parasitic inductance. In circumstances where the chip more than .001" thinner than the substrate, a heat spreading spacer tab is optional to further reduce bondwire length and parasitic inductance.

4.2 Bonding Diagram

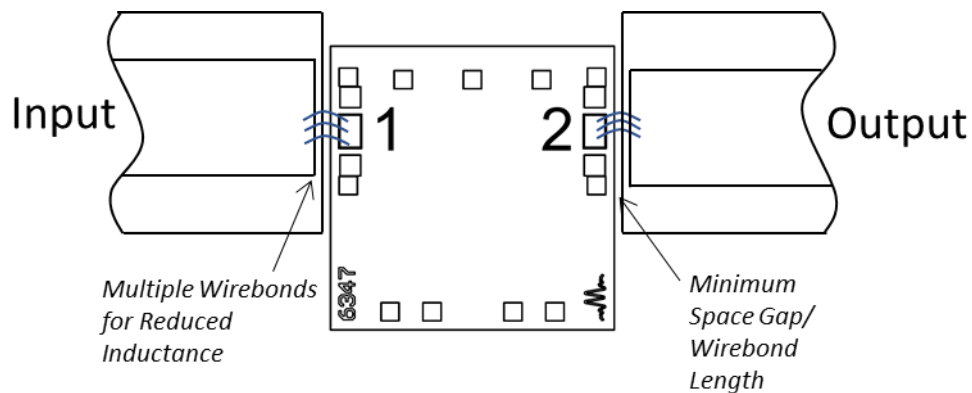

4.3 Handling Precautions

General Handling

Chips should be handled with care using tweezers or a vacuum collet. Users should take precautions to protect chips from direct human contact that can deposit contaminants, like perspiration and skin oils on any of the chip's surfaces.

Static Sensitivity

GaAs MMIC devices are sensitive to ESD and should be handled, assembled, tested, and transported only in static protected environments.

Cleaning and Storage: Do not attempt to clean the chip with a liquid cleaning system or expose the bare chips to liquid. Once the ESD sensitive bags the chips are stored in are opened, chips should be stored in a dry nitrogen atmosphere.

5 Mechanical Data

5.1 CH Package Outline Drawing

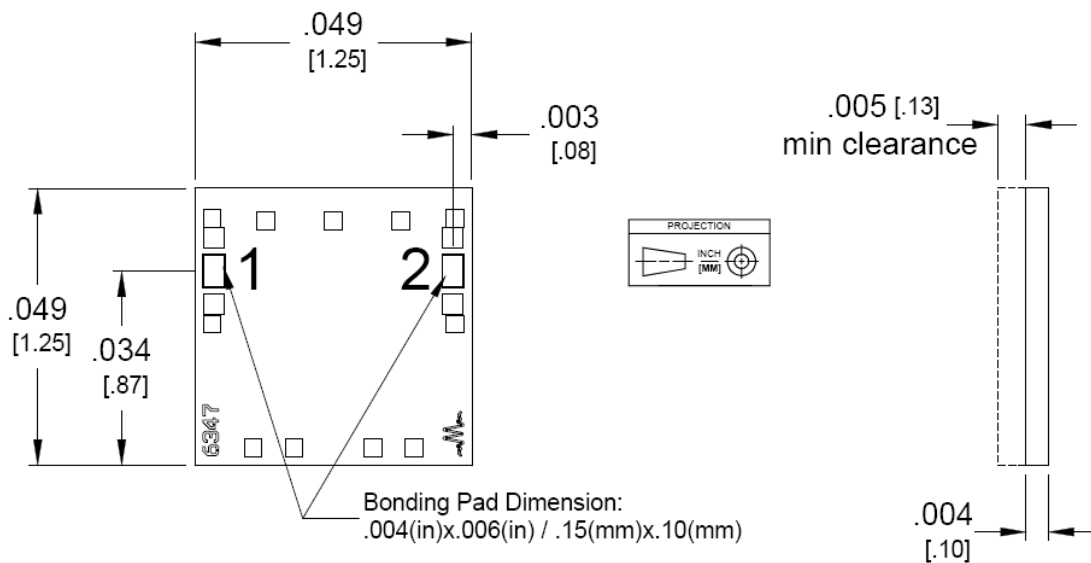

1. CH Substrate material is 0.004 in thick GaAs.
2. I/O trace finish is 5 microns Au. Ground plane finish is 4 microns Au.

Marki Microwave reserves the right to make changes to the product(s) or information contained herein without notice.

Marki Microwave makes no warranty, representation, or guarantee regarding the suitability of its products for any particular purpose, nor does Marki Microwave assume any liability whatsoever arising out of the use or application of any product.