

1 Device Overview

1.1 General Description

The MEQX-7ASM family of passive MMIC equalizer QFN are an ideal solution for compensating for low pass filtering effects in RF/microwave and high speed digital systems. They provide positive slope from DC to 7GHz with DC attenuation options between 3 and 12dB. The unique design offers superior return loss to competitors. GaAs MMIC technology provides consistent unit-to-unit performance in a small, low cost form factor.

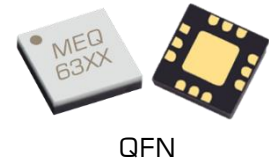

1.2 Features

- DC attenuation options from 3 to 12dB
- Typical Insertion Loss 1.1dB at 7GHz
- VSWR < 1.5:1 Over Entire Band
- S2P data: [MEQX-7ASM.zip](#)

1.3 Applications

- RF Transceivers
- High-Speed Data
- Telecom
- Cable Loss Compensation
- Amplifier Compensation

1.4 Functional Block Diagram



1.5 Part Ordering Options¹

Part Number	Loss at DC (dB)	Description	Package	Green Status	Product Lifecycle	Export Classification
MEQ3-7ASM	3	3x3 mm QFN	SM	RoHS	Active	EAR99
MEQ6-7ASM	6					
MEQ10-7ASM	10					
MEQ12-7ASM	12.5					
EVAL-MEQ3-7A	3	Connectorized Eval Board	Module			
EVAL-MEQ6-7A	6					
EVAL-MEQ10-7A	10					
EVAL-MEQ12-7A	12.5					

¹ Refer to our [website](#) for a list of definitions for terminology presented in this table.

Table of Contents

1	Device Overview	1	3.1	Absolute Maximum Ratings.....	4
1.1	General Description	1	3.2	Package Information.....	4
1.2	Features	1	3.3	Electrical Specifications	4
1.3	Applications	1	3.4	Typical Performance Plots	5
1.4	Functional Block Diagram	1	3.4.1	Insertion Loss	5
1.5	Part Ordering Options.....	1	3.4.2	Return Loss & Group Delay ..	6
2	Port Configurations and Functions	3	4	Mechanical Data.....	7
2.1	Port Diagram.....	3	4.1	SM Package Outline Drawing	7
2.2	Port Functions	3	4.2	SM Package Footprint	7
3	Specifications	4	4.3	Eval Package Outline Drawing	8

Revision History

Revision Code	Revision Date	Comment
-	May 2018	Datasheet Initial Release
A	August 2018	Added §4.3, EVAL Outline
B	November 2018	Updated §4.3, EVAL Outline
C	March 2019	Updated ESD Rating
D	May 2019	Added Package Dimension Tolerance Spec
E	August 2019	Added §4.2, SM Footprint

2 Port Configurations and Functions

2.1 Port Diagram

A top-down view of the MEQX-7A CH package outline drawing is shown below. The MEQ equalizers are symmetrical allowing Port 1 or Port 2 to be used as the input.

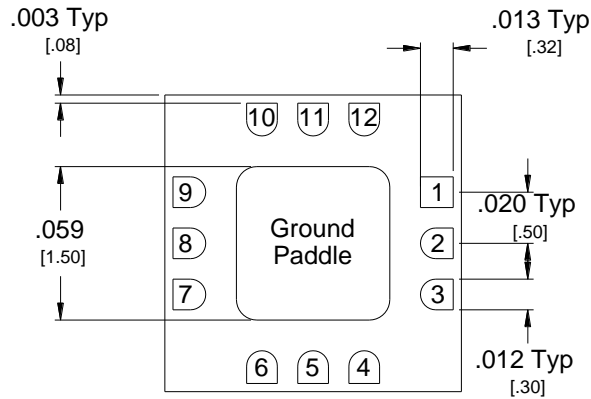

2.2 Port Functions

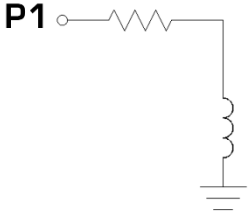
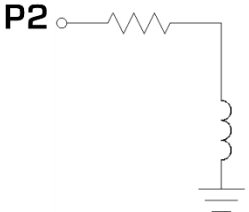
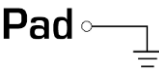
Port	Function	Description	Equivalent Circuit
Pin 1	Input/Output	Port 1 is DC connected to ground through a resistor. DC block is required if voltage present.	
Pin 9	Input/Output	Port 2 is DC connected to ground through a resistor. DC block is required if voltage present.	
GND	Ground	SM package ground path is provided through the ground paddle.	

3 Specifications

3.1 Absolute Maximum Ratings

The Absolute Maximum Ratings indicate limits beyond which damage may occur to the device. If these limits are exceeded, the device may be inoperable or have a reduced lifetime.

Parameter	Maximum Rating	Units
Port 1 DC Current	40	mA
Port 2 DC Current	40	mA
Power Handling, at any Port	+30	dBm
Operating Temperature	-55 to +100	°C
Storage Temperature	-65 to +125	°C

3.2 Package Information

Parameter	Details	Rating
ESD	Human Body Model (HBM), per MIL-STD-750, Method 1020	1A

3.3 Electrical Specifications²

The electrical specifications apply at $T_A=+25^{\circ}\text{C}$ in a 50Ω system. Typical data shown is for the equalizer in a CH package with a sine wave input applied to port 1.

Min and Max limits are guaranteed at $T_A=+25^{\circ}\text{C}$. All bare die are 100% DC tested and visually inspected.

Part Number	Typical Insertion Loss		Typical Return Loss	Units
	DC	7 GHz	DC-7 GHz	
MEQ3-7ASM	3	1.1	29	dB
MEQ6-7ASM	6	1.1	29	dB
MEQ10-7ASM	10	1.1	27	dB
MEQ12-7ASM	12.5	1.3	27	dB

² Equalizer is symmetrical. Reverse measurement is equivalent to forward measurement. All measurements taken in eval board without de-embedding.

3.4 Typical Performance Plots

3.4.1 Insertion Loss

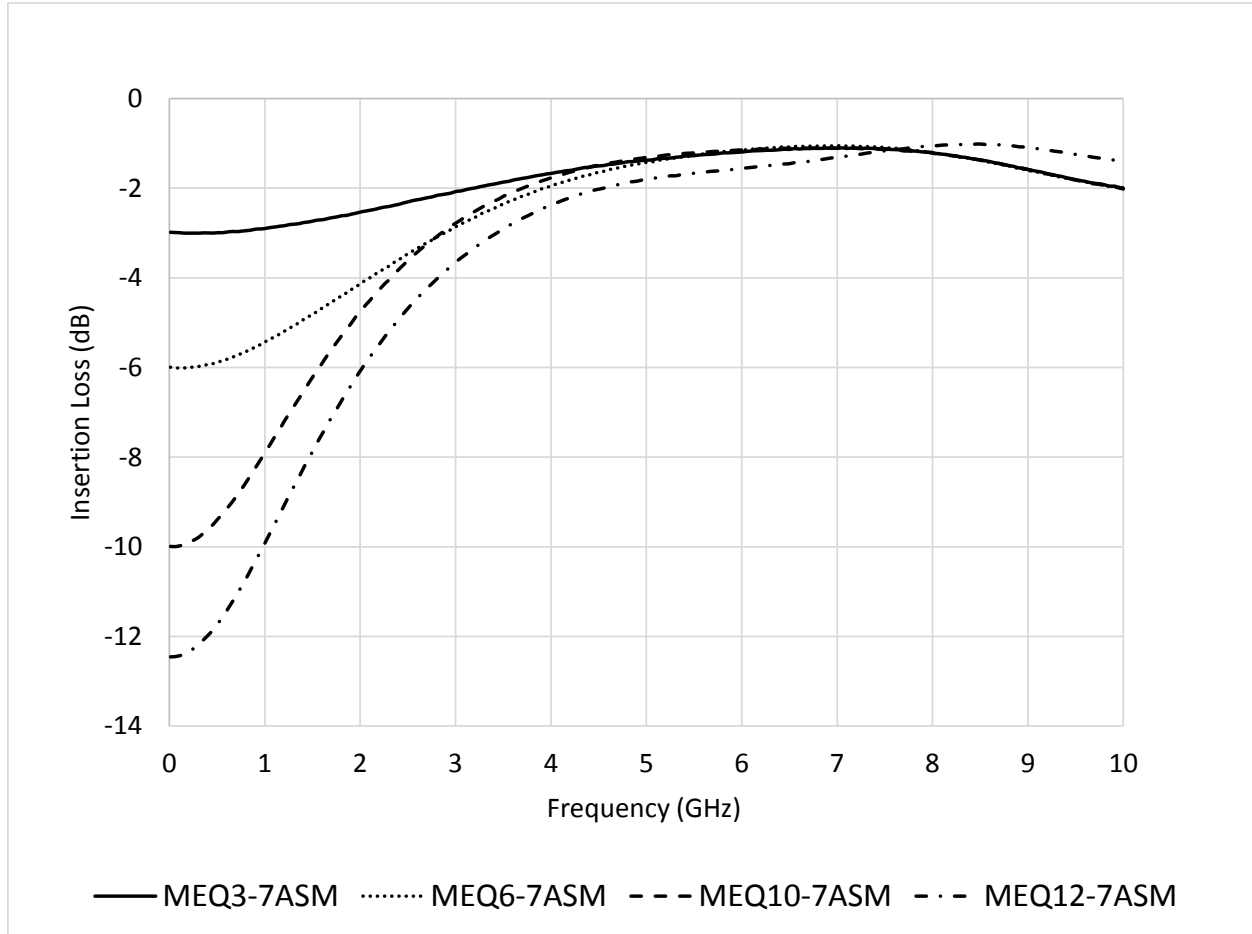

3.4.2 Return Loss & Group Delay³

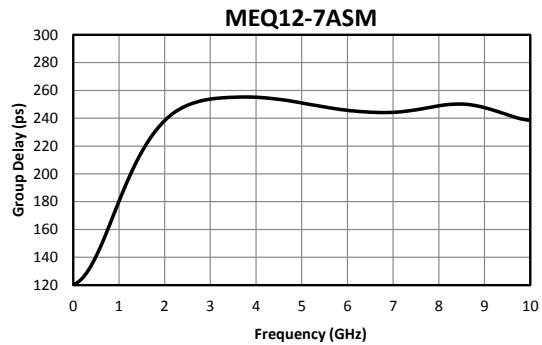
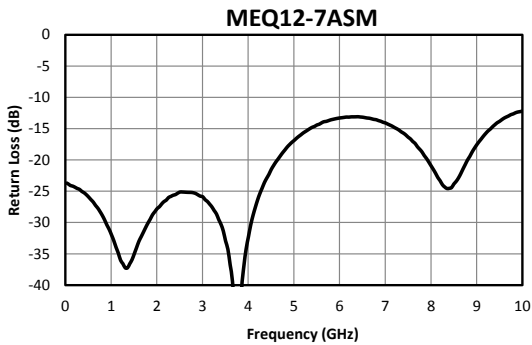
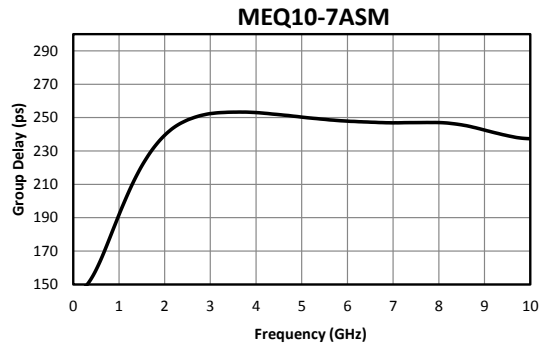
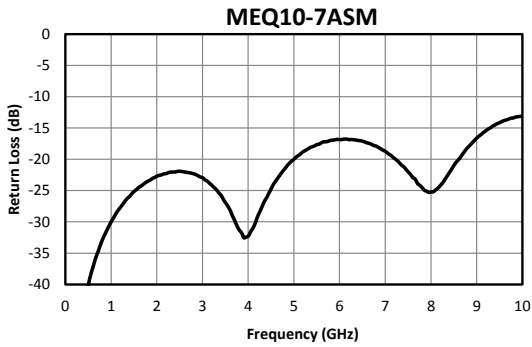
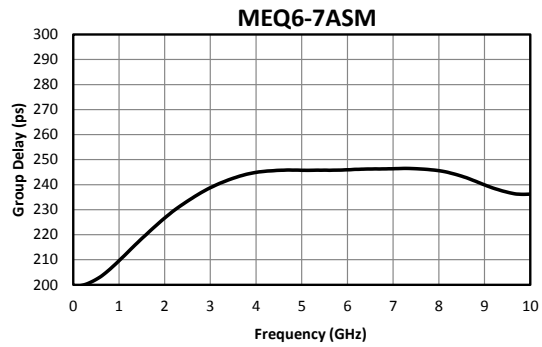
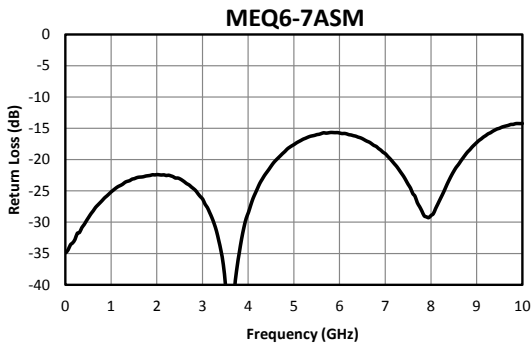
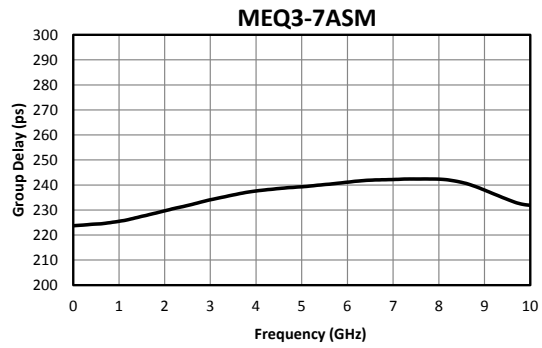
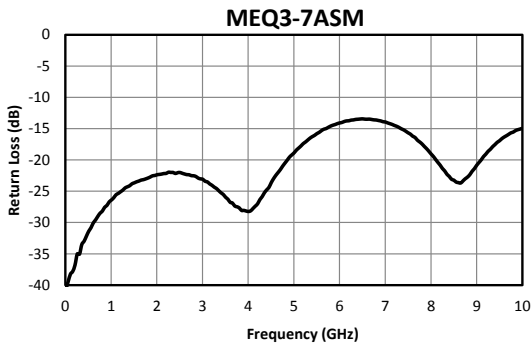

³ Group delay measured in eval board without de-embedding.

4 Mechanical Data

4.1 SM Package Outline Drawing

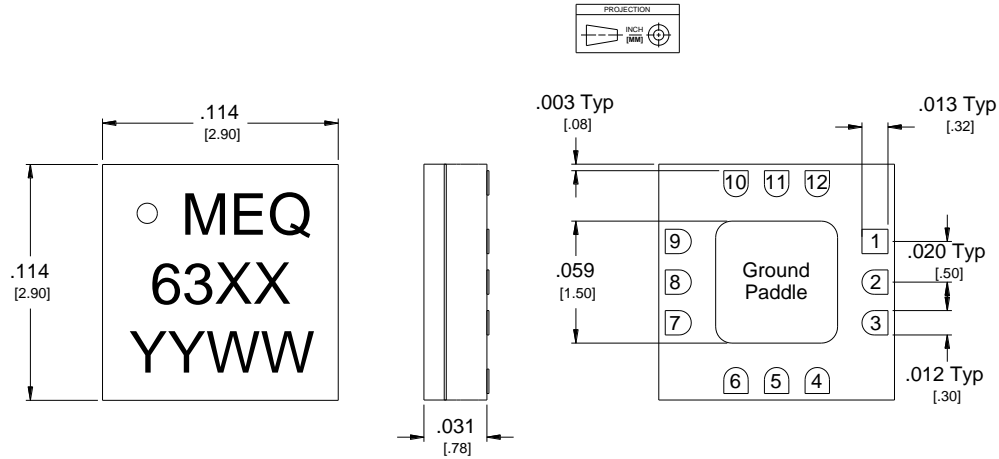

Unless otherwise specified, dimensions are in inches. Tolerances are:

.XX ±.02
.XXX ±.005

- Substrate material is ceramic.
- I/O Leads and Ground Paddle plating is (from base to finish):
Ni: 8.89um MAX 1.27um MIN
Pd: 0.17um MAX 0.07um MIN
Au 0.254um MAX 0.03um MIN
- All unconnected pads should be connected to PCB RF ground.

Part Number	Circuit Number
MEQ3-7ASM	6333
MEQ6-7ASM	6334
MEQ10-7ASM	6335
MEQ12-7ASM	6344

4.2 SM Package Footprint

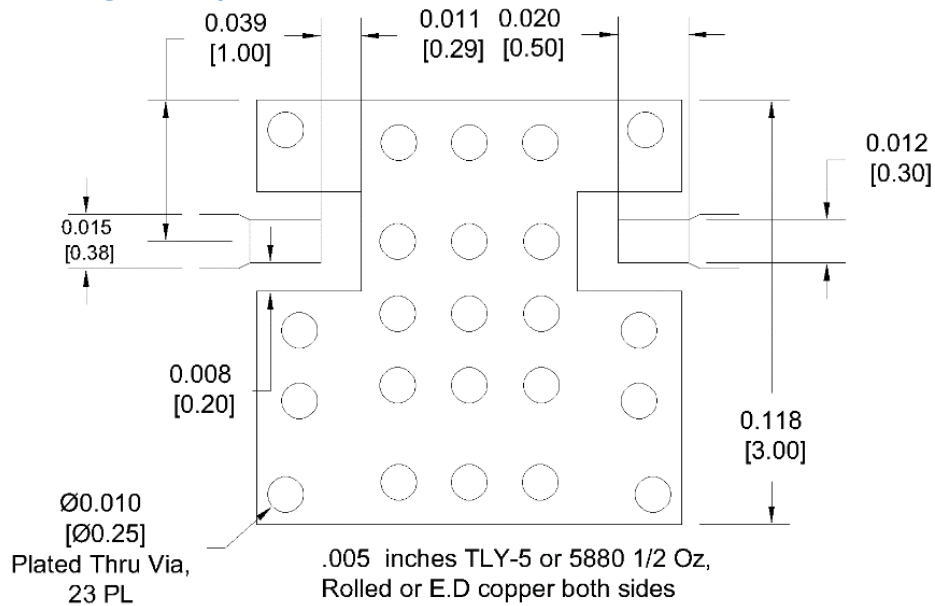

SM-Package Surface-Mount Landing Pattern

[Click here for a DXF of the above layout.](#)

[Click here for leaded solder reflow.](#) [Click here for lead-free solder reflow](#)

4.3 Eval Package Outline Drawing

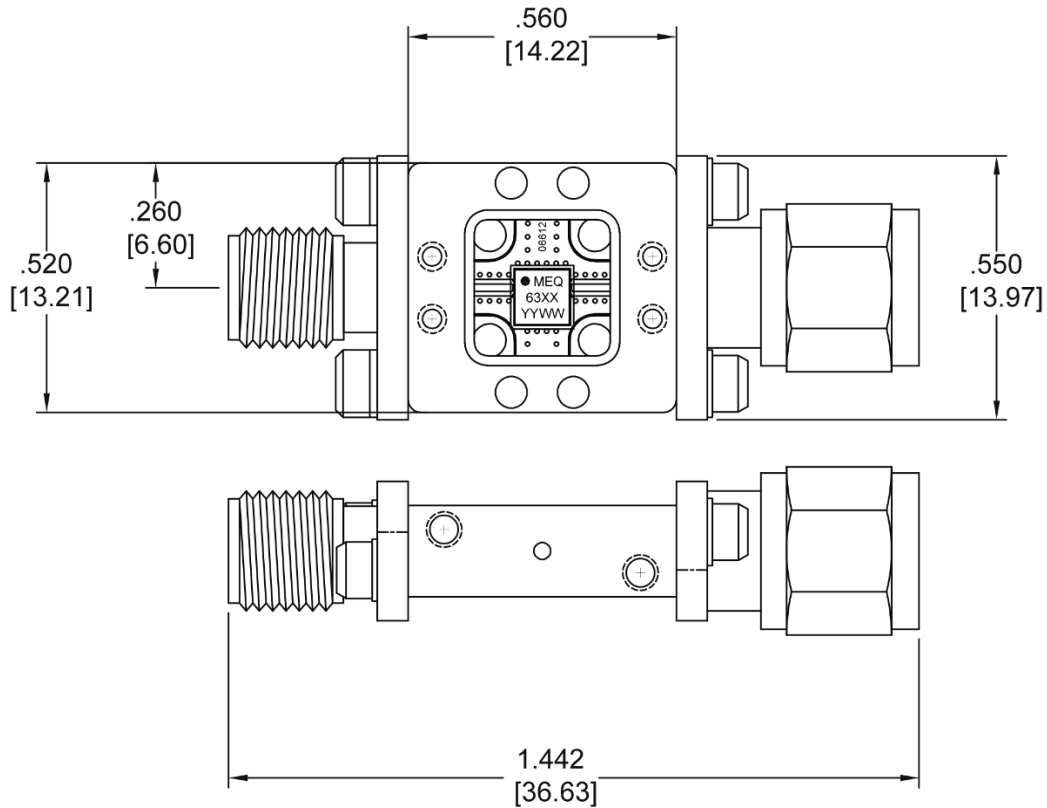

XX	Part Number
33	Eval-MEQ3-7A
34	Eval-MEQ6-7A
35	Eval-MEQ10-7A
44	Eval-MEQ12-7A

Port	Connector Type
I	SMA Female
O	SMA Male
Note: Eval-Package Connectors are not removeable.	

Unless otherwise specified, dimensions are in inches. Tolerances are:

.XX ±.02
.XXX ±.005

Marki Microwave reserves the right to make changes to the product(s) or information contained herein without notice.
Marki Microwave makes no warranty, representation, or guarantee regarding the suitability of its products for any particular purpose, nor does Marki Microwave assume any liability whatsoever arising out of the use or application of any product.