

## 1 Device Overview

### 1.1 General Description

The MEQX-7ASM family of passive MMIC equalizer QFN are an ideal solution for compensating for low pass filtering effects in RF/microwave and high speed digital systems. They provide positive slope from DC to 7GHz with DC attenuation options between 3 and 12dB. The unique design offers superior return loss to competitors. GaAs MMIC technology provides consistent unit-to-unit performance in a small, low cost form factor.

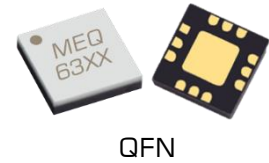

### 1.2 Features

- DC attenuation options from 3 to 12dB
- Typical Insertion Loss 1.1dB at 7GHz
- VSWR < 1.5:1 Over Entire Band
- S2P data: [MEQX-7ASM.zip](#)

### 1.3 Applications

- RF Transceivers
- High-Speed Data
- Telecom
- Cable Loss Compensation
- Amplifier Compensation

### 1.4 Functional Block Diagram



### 1.5 Part Ordering Options<sup>1</sup>

Part Number	Loss at DC (dB)	Description	Package	Green Status	Product Lifecycle	Export Classification
MEQ3-7ASM	3	3x3 mm QFN	SM	RoHS	Active	EAR99
MEQ6-7ASM	6					
MEQ10-7ASM	10					
MEQ12-7ASM	12.5					
EVAL-MEQ3-7A	3	Connectorized Eval Board	Module			
EVAL-MEQ6-7A	6					
EVAL-MEQ10-7A	10					
EVAL-MEQ12-7A	12.5					

<sup>1</sup> Refer to our [website](#) for a list of definitions for terminology presented in this table.

## Table of Contents

1	Device Overview .....	1	3.1	Absolute Maximum Ratings.....	4
1.1	General Description .....	1	3.2	Package Information.....	4
1.2	Features .....	1	3.3	Electrical Specifications .....	4
1.3	Applications .....	1	3.4	Typical Performance Plots .....	5
1.4	Functional Block Diagram .....	1	3.4.1	Insertion Loss .....	5
1.5	Part Ordering Options.....	1	3.4.2	Return Loss & Group Delay ..	6
2	Port Configurations and Functions .....	3	4	Mechanical Data.....	7
2.1	Port Diagram.....	3	4.1	SM Package Outline Drawing.....	7
2.2	Port Functions .....	3	4.2	Eval Package Outline Drawing .....	8
3	Specifications .....	4			

## Revision History

Revision Code	Revision Date	Comment
-	May 2018	Datasheet Initial Release
A	August 2018	Added Section 4.2
B	November 2018	Updated Section 4.2
C	March 2019	Updated ESD Rating

## 2 Port Configurations and Functions

### 2.1 Port Diagram

A top-down view of the MEQX-7A CH package outline drawing is shown below. The MEQ equalizers are symmetrical allowing Port 1 or Port 2 to be used as the input.

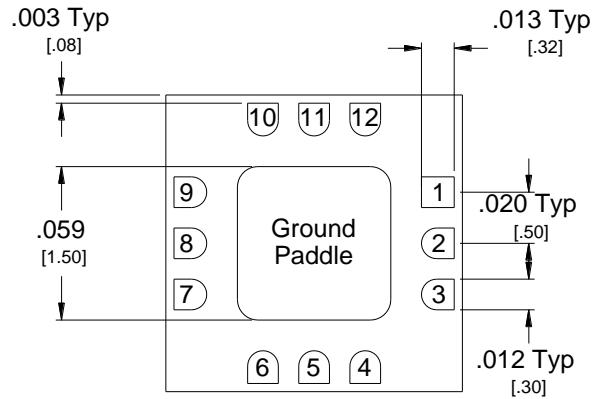

### 2.2 Port Functions

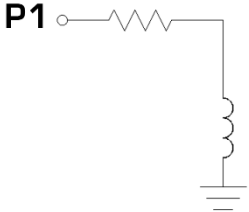
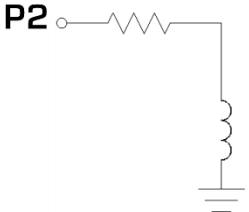
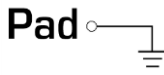
Port	Function	Description	Equivalent Circuit
Pin 1	Input/Output	Port 1 is DC connected to ground through a resistor. DC block is required if voltage present.	
Pin 9	Input/Output	Port 2 is DC connected to ground through a resistor. DC block is required if voltage present.	
GND	Ground	SM package ground path is provided through the ground paddle.	

### 3 Specifications

#### 3.1 Absolute Maximum Ratings

The Absolute Maximum Ratings indicate limits beyond which damage may occur to the device. If these limits are exceeded, the device may be inoperable or have a reduced lifetime.

Parameter	Maximum Rating	Units
Port 1 DC Current	40	mA
Port 2 DC Current	40	mA
Power Handling, at any Port	+30	dBm
Operating Temperature	-55 to +100	°C
Storage Temperature	-65 to +125	°C

#### 3.2 Package Information

Parameter	Details	Rating
ESD	Human Body Model (HBM), per MIL-STD-750, Method 1020	1A

#### 3.3 Electrical Specifications<sup>2</sup>

The electrical specifications apply at  $T_A=+25^{\circ}\text{C}$  in a  $50\Omega$  system. Typical data shown is for the equalizer in a CH package with a sine wave input applied to port 1.

Min and Max limits are guaranteed at  $T_A=+25^{\circ}\text{C}$ . All bare die are 100% DC tested and visually inspected.

Part Number	Typical Insertion Loss		Typical Return Loss	Units
	DC	7 GHz	DC-7 GHz	
MEQ3-7ASM	3	1.1	29	dB
MEQ6-7ASM	6	1.1	29	dB
MEQ10-7ASM	10	1.1	27	dB
MEQ12-7ASM	12.5	1.3	27	dB

<sup>2</sup> Equalizer is symmetrical. Reverse measurement is equivalent to forward measurement. All measurements taken in eval board without de-embedding.

### 3.4 Typical Performance Plots

#### 3.4.1 Insertion Loss

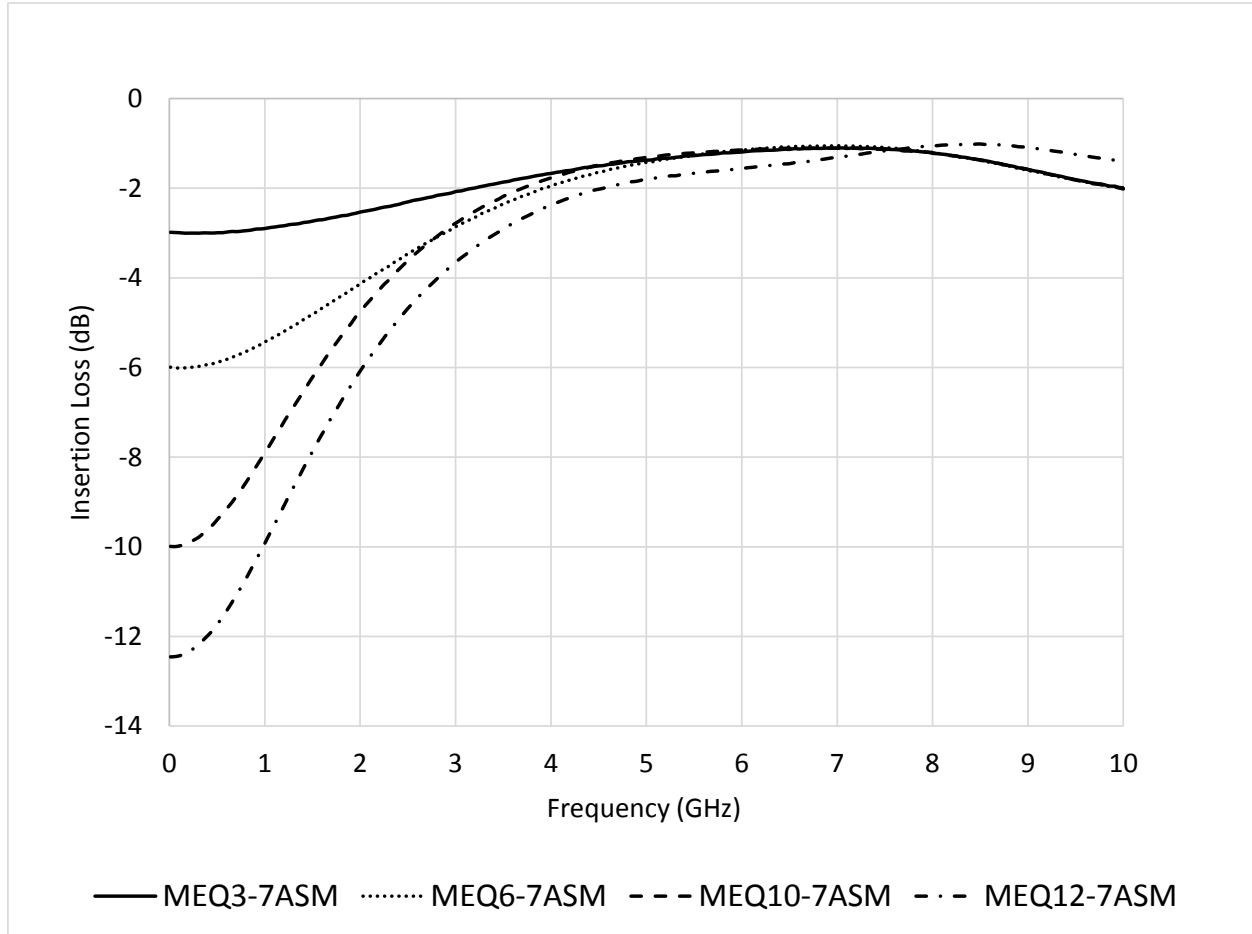

### 3.4.2 Return Loss & Group Delay<sup>3</sup>

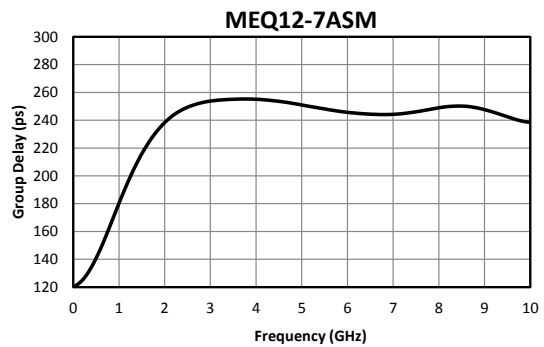
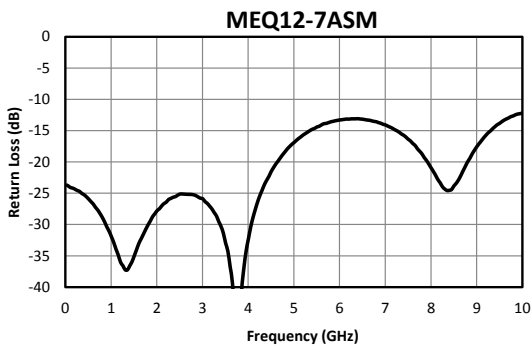
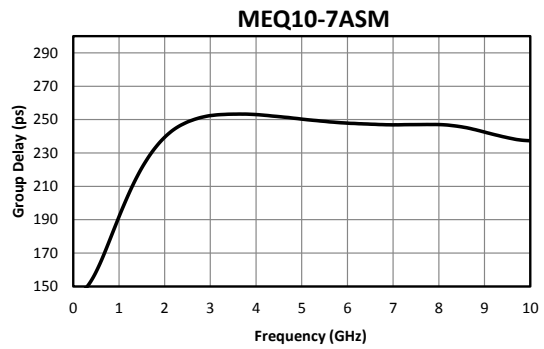
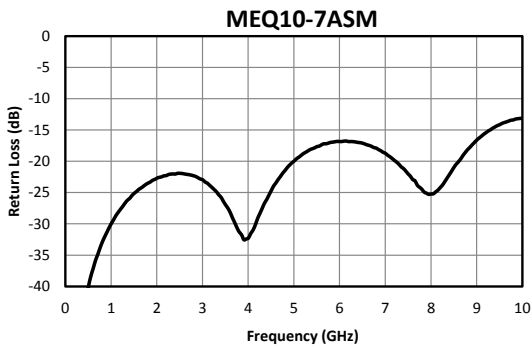
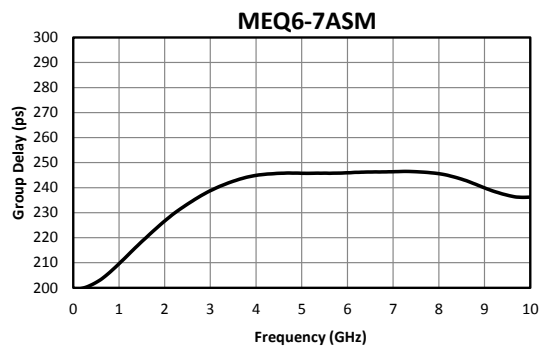
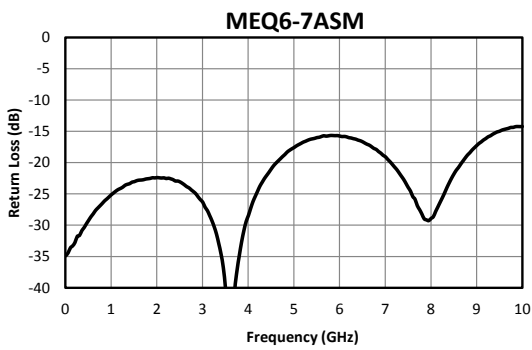
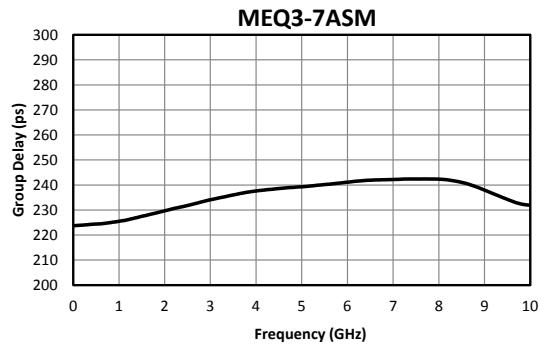
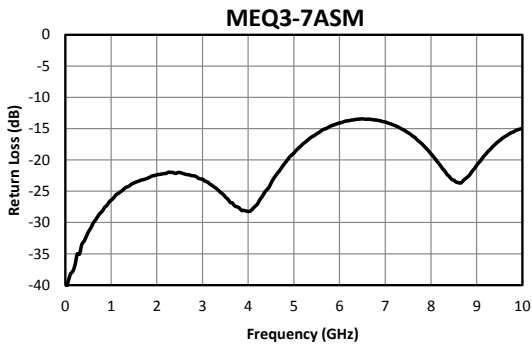

<sup>3</sup> Group delay measured in eval board without de-embedding.

## 4 Mechanical Data

### 4.1 SM Package Outline Drawing

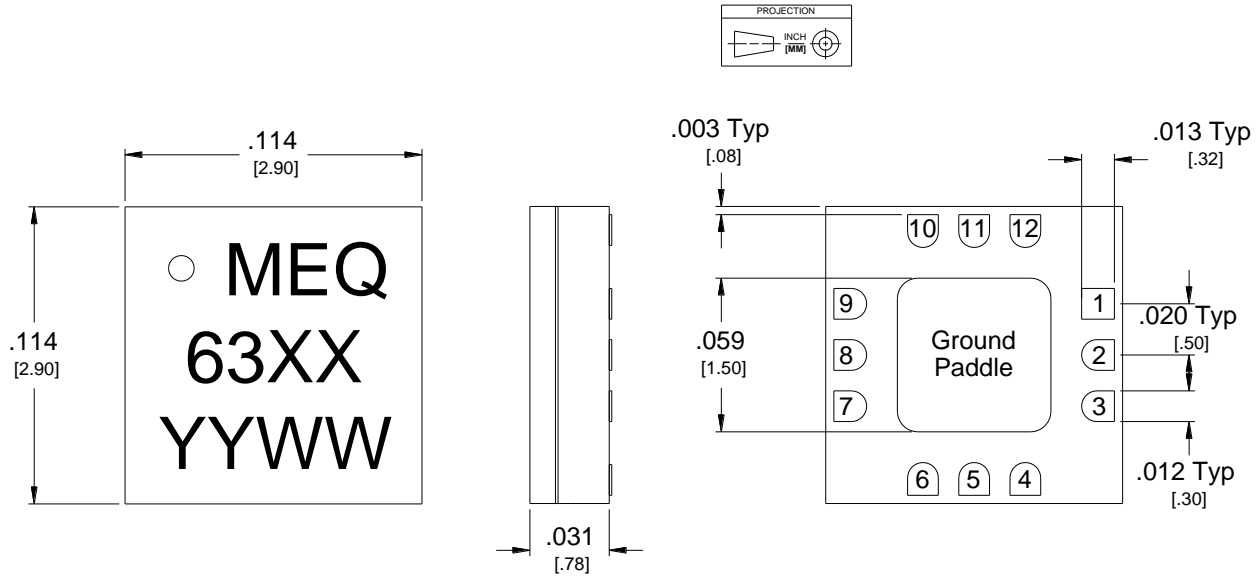

- Substrate material is ceramic.
- I/O Leads and Ground Paddle plating is (from base to finish):
  - Ni: 8.89um MAX 1.27um MIN
  - Pd: 0.17um MAX 0.07um MIN
  - Au 0.254um MAX 0.03um MIN
- All unconnected pads should be connected to PCB RF ground.

Part Number	Circuit Number
MEQ3-7ASM	6333
MEQ6-7ASM	6334
MEQ10-7ASM	6335
MEQ12-7ASM	6344

## 4.2 Eval Package Outline Drawing

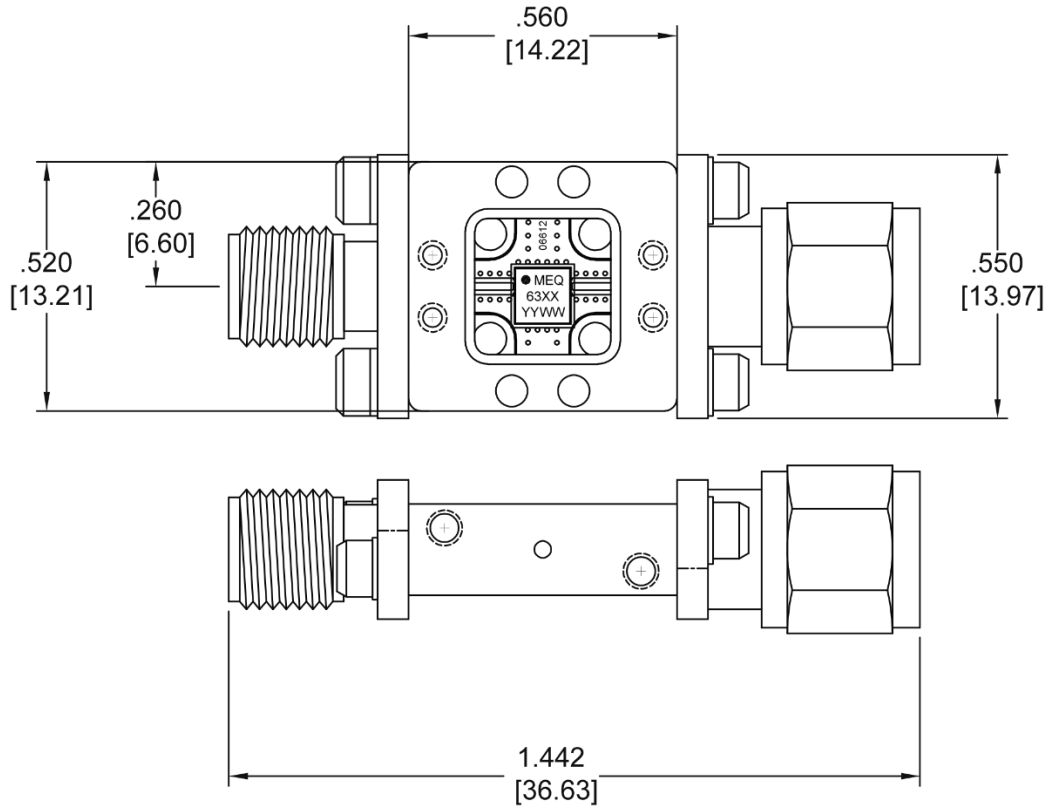

XX	Part Number
33	Eval-MEQ3-7A
34	Eval-MEQ6-7A
35	Eval-MEQ10-7A
44	Eval-MEQ12-7A

Port	Connector Type
I	SMA Female
O	SMA Male

Note: Eval-Package Connectors are not removeable.