

## Passive MMIC 1-4GHz Surface Mount Balun

**MBAL-0104SM**

Page 1

The MBAL-0104SM is a GaAs passive MMIC balun in a 4mm QFN surface mount package. It features excellent amplitude and phase balance across its 1 to 4 GHz frequency range that offers a 1:2 impedance ratio. The 4mm QFN package is a lead free, RoHS compliant package compatible with standard leaded and lead-free solder reflows. SMA connectorized evaluation packages are available. The MBAL-0104SM is an excellent choice for balanced amplifiers, clock distribution, and higher order Nyquist sampling in analog to digital converters.

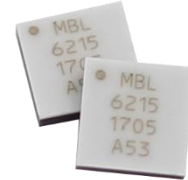

### Features

- 1 GHz to 4 GHz 1:2 Balun (Balanced to Unbalanced Transformer)
- Transforms 50  $\Omega$  Input to 100  $\Omega$  Differential (50 Ohm Single) Output
- Tuned for Optimal Phase/Amplitude Balance
- Applications: Analog to Digital Converters, Balanced Receivers, Baseband Digital Modulation, Signal Integrity
- RoHS Compliant
- [MBAL-0104SM.S2P](#)

**Electrical Specifications** - Specifications guaranteed for +25°C, measured in a 50 $\Omega$  system.

Parameter	Frequency Range	Min	Typ	Max	
Nominal Insertion Loss (dB)	1 GHz to 4 GHz		3		
Nominal Phase Shift (Degrees)			180		
Amplitude Balance (dB)			$\pm 0$	$\pm 0.5$	
Phase Balance (Degrees)			$\pm 2$	$\pm 5$	
Common Mode Rejection (dB)			25	33	
Excess Insertion Loss (dB) <sup>1-2</sup>				2.5	5
Isolation (dB)				8	
Output VSWR				3.6	
Common Port VSWR				1.25	

<sup>1</sup>Excess Insertion Loss = (Common Port to Output Port Insertion Loss) – 3dB.

<sup>2</sup>Includes fixture losses.

### Part Number Options

Model Number	Description
MBAL-0104SM <sup>1</sup>	1 GHz to 4 GHz MMIC Balun, Surface Mount
EVAL-MBAL-0104	Connectorized Evaluation Module

<sup>1</sup>Note: For port locations and I/O designations, refer to the drawings on page 2 of this document.

# Passive MMIC 1-4GHz Surface Mount Balun

# MBAL-0104SM

Page 2

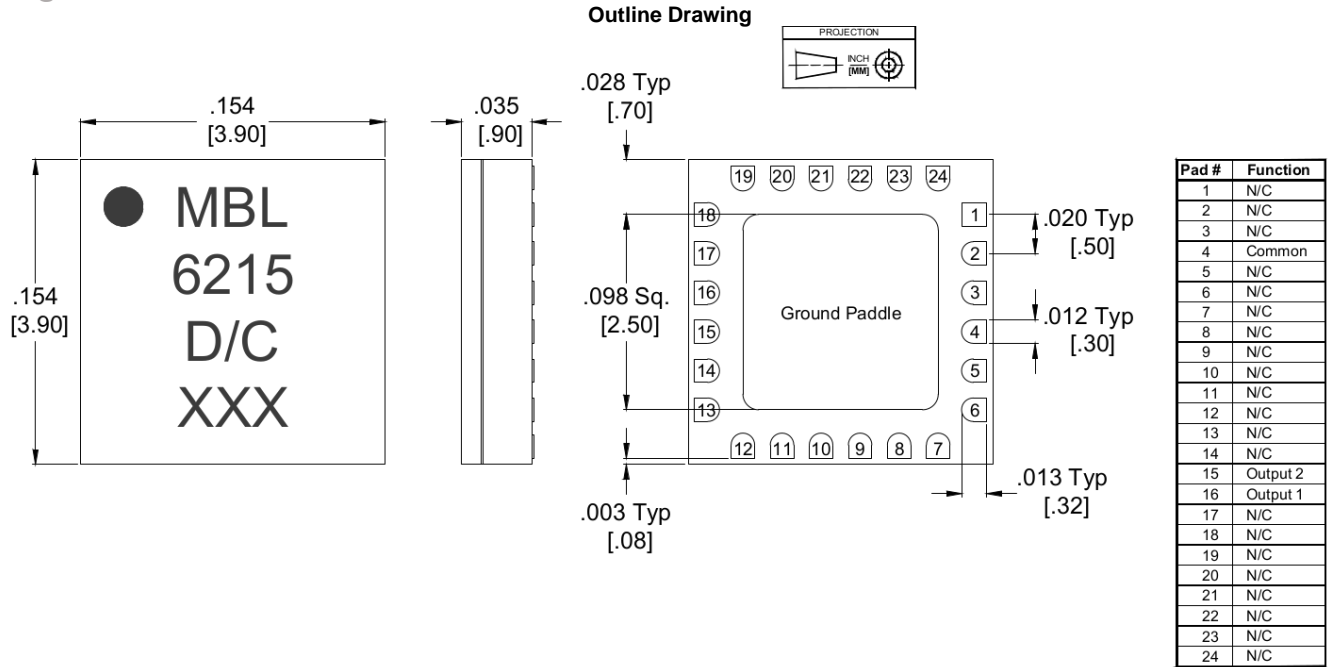

1. Substrate material is Ceramic.
2. I/O Leads and Ground Paddle are 1.4±0.6 microns (55±24 micro-inches) Au over 1.3 microns (51 micro-inches) Ni.
3. All unconnected pads should be connected to PCB RF ground.

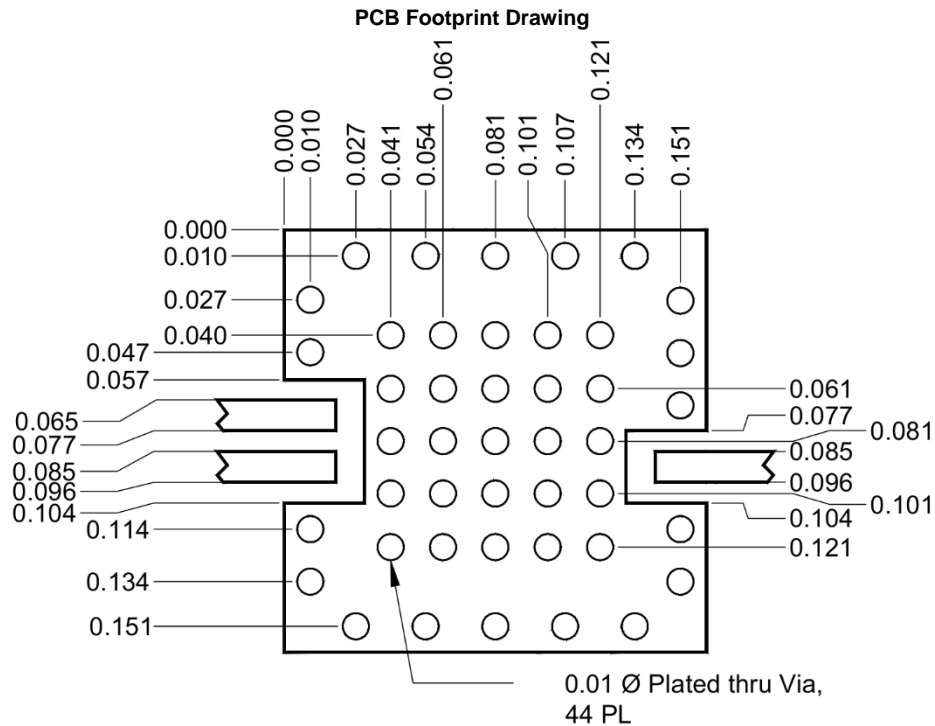

QFN-Package Surface-Mount Landing Pattern

[Click here for a DXF of the above layout.](#)

[Click here for leaded solder reflow.](#) [Click here for lead-free solder reflow.](#)

# Passive MMIC 1-4GHz Surface Mount Balun

# MBAL-0104SM

Page 3

## Typical Performance

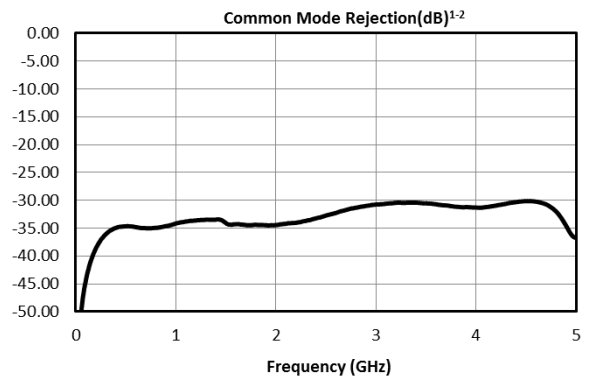
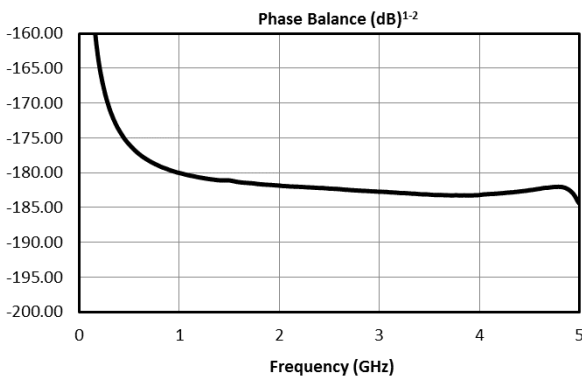
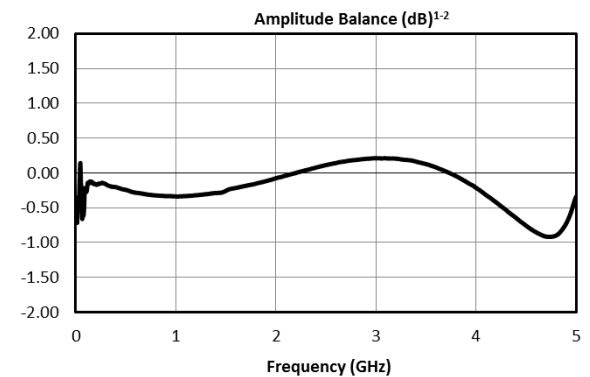
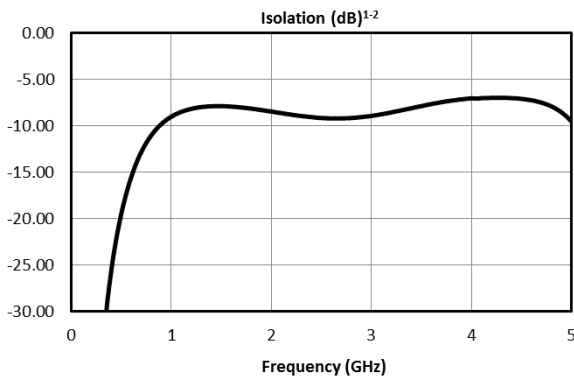
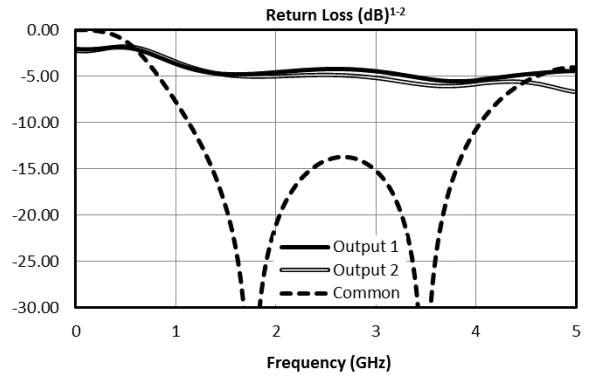
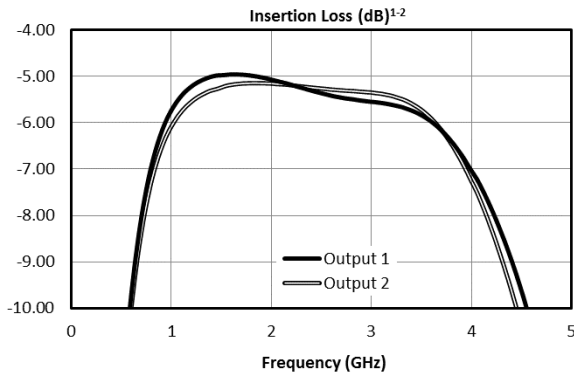

# Passive MMIC 1-4GHz Surface Mount Balun

# MBAL-0104SM

Page 4

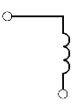
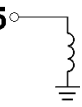
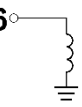
Pin Number	Function	Description	DC Interface Schematic
1-3, 5-14, 17-24	Non-connect (NC)	These pins are not connected internally. Datasheet performance is tested with NC pins grounded.	
4	Common	Pin 4 is DC open and AC matched to 50 Ω from 1 to 4 GHz. Blocking capacitor is optional.	
15	Out 2	Pin 15 is DC short. Blocking capacitor is optional.	
16	Out 1	Pin 16 is DC short. Blocking capacitor is optional.	
Paddle	Ground (GND)	Ground pad should be connected to RF/DC ground with low electrical and thermal resistance.	

Absolute Maximum Ratings	
Parameter	Maximum Rating
Output Port 1 DC Current	N/A
Output Port 2 DC Current	N/A
Common Port DC Current	N/A
RF Power Handling	+30 dBm
Operating Temperature	-65°C to +125°C
Storage Temperature	-65°C to +125°C

**DATA SHEET NOTES:**

- Balun measured as a splitter. Combiner measurement is equivalent to splitter measurement.
- Specifications are subject to change without notice. Contact Marki Microwave for the most recent specifications and data sheets.
- Catalog circuits are continually improved. Configuration control requires custom model numbers and specifications

**Note:** Exposure to maximum rating conditions for extended periods may reduce device reliability. There is no damage to device with only one parameter set at the limit and all other parameters set at or below their nominal value. Exceeding any of the limits listed here may result in permanent damage to the device.

*Marki Microwave reserves the right to make changes to the product(s) or information contained herein without notice. Marki Microwave makes no warranty, representation, or guarantee regarding the suitability of its products for any particular purpose, nor does Marki Microwave assume any liability whatsoever arising out of the use or application of any product.*

© Marki Microwave, Inc.



[www.markimicrowave.com](http://www.markimicrowave.com)