

Elite 2-40 GHz Directional Coupler

CE13-0240

1 Device Overview

1.1 General Description

The CE13-0240 is a next generation broadband 2GHz to 40GHz, 13dB directional coupler from the Marki Elite Series. Conductive paint is applied to all Elite Series products to reduce EMI/RFI leakage and susceptibility. The CE13-0240 offers the best directivity, return loss, and coupling accuracy available on the market. Available as both a three port directional coupler and a four port bidirectional coupler, the CE13-0240 is an exceptional choice for broadband return loss measurements, power leveling, and signal monitoring applications. Sophisticated neural network design techniques combined with deep circuit knowledge and triplate stripline construction allow the Marki Elite Series of Couplers to provide superior performance to all other directional couplers available.



Module

1.2 Features

- Broadband Performance
- Excellent Coupling Flatness
- High Directivity
- Low VSWR
- Conductive paint minimizes RF leakage
- [CE13-0240.S4P](#), [CE13-0240T.S3P](#)
- [Microwave Power Dividers & Couplers App Note](#)

1.3 Functional Block Diagram

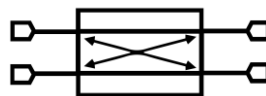

1.4 Part Ordering Options¹

Part Number	Description	Green Status	Product Lifecycle	Export Classification
CE13-0240	Connectorized module; 2.92mm connector ports ²	RoHS	Active	EAR99
CE13-0240T	Connectorized module; 50Ω termination included	RoHS	Active	EAR99

¹ Refer to our [website](#) for a list of definitions for terminology presented in this table.

² Default configurations has 2.92mm female connectors on all ports. Consult factory for other connector options.

Table of Contents

1	Device Overview	1	3.3.2	Terminated Electrical Specifications	5
1.1	General Description	1	3.4	Typical Performance Plots	6
1.2	Features	1	3.4.1	Insertion Loss, Return Loss, Coupled Port Power, and Directivity	6
1.3	Functional Block Diagram	1	3.4.2	Performance Over Temperature.....	7
1.4	Part Ordering Options.....	1	3.4.3	Terminated Return Loss and Directivity	7
2	Port Configurations and Functions	3	4	Mechanical Data.....	8
2.1	Port Diagram.....	3	4.1	Connectorized Module Outline Drawing CE13-0240	8
2.2	Port Functions	3	4.2	Connectorized Module Outline Drawing CE13-0240T	8
3	Specifications	4			
3.1	Absolute Maximum Ratings.....	4			
3.2	Package Information.....	4			
3.3	Electrical Specifications	4			
3.3.1	CE13-0240 Electrical Specifications	4			

Revision History

Revision Code	Revision Date	Comment
-	December 2021	Datasheet Initial Release
A	April 2022	Terminated Option Added, Operating and Storage Temperatures Updated

2 Port Configurations and Functions

2.1 Port Diagram

A side view of the CE13-0240 package outline drawing is shown below. The CE13-0240 has input and output ports given in Port Functions. The CE13-0240 can be used in either the forward or reverse direction corresponding to configuration A and B respectively. For configuration A, input signal into port 1, use port 3 for coupled port, port 2 for isolated port, and port 4 for output port. For configuration B, input signal into port 4, use port 2 for coupled port, port 3 for isolated port, and port 1 for output port.

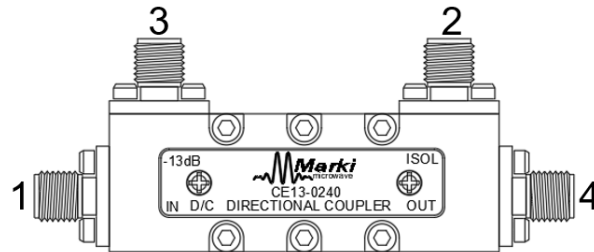

2.2 Port Functions³

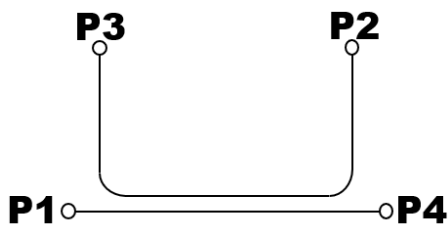
Port	Function	Description	Equivalent Circuit
Port 1	Input (Configuration A) Output (Configuration B)	The input port is DC short to the output port and open to the isolated and coupled ports.	
Port 2	Isolated (Configuration A) Coupled (Configuration B)	The isolated port is DC short to the coupled port and open to the input and output ports.	
Port 3	Coupled (Configuration A) Isolated (Configuration B)	The coupled port is DC short to the isolated port and open to the input and output ports.	
Port 4	Output (Configuration A) Input (Configuration B)	The output port is DC short to the input port and open to the isolated and coupled ports.	

³ Port two is loaded in the CE13-0240T and the device can only be used in configuration A.

3 Specifications

3.1 Absolute Maximum Ratings

The Absolute Maximum Ratings indicate limits beyond which damage may occur to the device. If these limits are exceeded, the device may be inoperable or have a reduced lifetime.

Parameter	Maximum Rating	Units
Power Handling, at any Port	20	W
Operating Temperature	TBD	°C
Storage Temperature	TBD	°C

3.2 Package Information

Parameter	Details	Rating
ESD	Human Body Model (HBM), per MIL-STD-750, Method 1020	N/A

3.3 Electrical Specifications

The electrical specifications apply for configuration A at $T_A=+25^\circ\text{C}$ in a 50Ω system.

3.3.1 CE13-0240 Electrical Specifications

Min and Max limits are guaranteed at $T_A=+25^\circ\text{C}$.

Parameter	Frequency (GHz)	Min	Typ.	Max
Average Coupling Factor (dB)	2-40	12.5	13.0	13.5
Coupling Loss (dB) ⁴	2-40	.20	.22	.25
Direct Line Insertion Loss (dB)	DC-40		.75	1.45
Excess Insertion Loss (dB) ⁵	DC-40		.50	1.20
Amplitude Flatness (dB) ⁶	2-40		$\pm .15$	$\pm .40$
Maximum Coupling Deviation (dB)	2-40		$\pm .50$	± 1.00
Standard Directivity (dB)	2-40	17	28	
IL Corrected Directivity (dB) ⁷	2-40	17	29	
Pass Band Return Loss (dB)	DC-40	20	30	
Pass Band VSWR	DC-40		1.07	1.22
Impedance (Ω)			50	

3.3.2 Terminated Electrical Specifications

Min and Max limits are guaranteed at $T_A=+25^{\circ}\text{C}$.

Parameter	Frequency (GHz)	Min	Typ.	Max
Average Coupling Factor (dB)	2-40	12.5	13.0	13.5
Coupling Loss (dB) ⁴	2-40	.20	.22	.25
Direct Line Insertion Loss (dB)	DC-40		.75	1.45
Excess Insertion Loss (dB) ⁵	DC-40		.50	1.20
Amplitude Flatness (dB) ⁶	2-40		± 0.15	± 0.40
Maximum Coupling Deviation (dB)	2-40		± 0.50	± 1.00
Standard Directivity (dB)	2-40	16	26	
IL Corrected Directivity (dB) ⁷	2-40	17	27	
Pass Band Return Loss (dB)	DC-40	18	28	
Pass Band VSWR	DC-40		1.08	1.29
Impedance (Ω)			50	

⁴ Coupling loss based on average coupling factor – visit our [website](#) to learn more.

⁵ Excess Insertion Loss = (Input Port to Output Port Insertion Loss) – Coupling Loss.

⁶ Amplitude Flatness = Median value of ABS(Measured Coupling Power – Average Coupling Factor).

⁷ IL Corrected Directivity = Directivity + Insertion Loss.

3.4 Typical Performance Plots⁸

3.4.1 Insertion Loss, Return Loss, Coupled Port Power, and Directivity

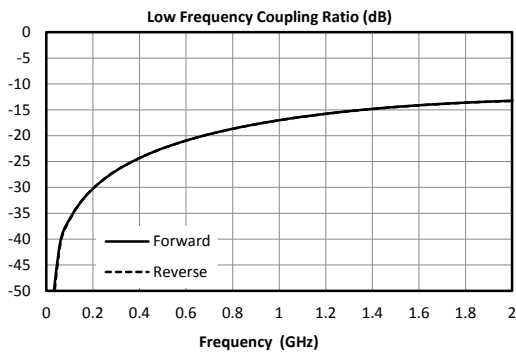
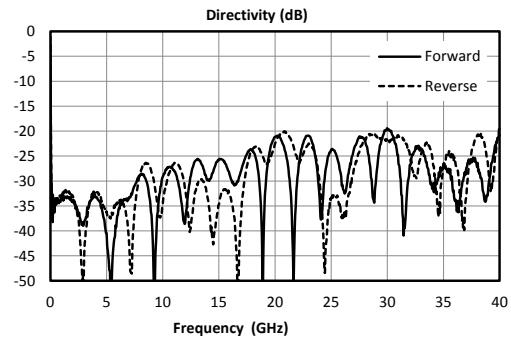
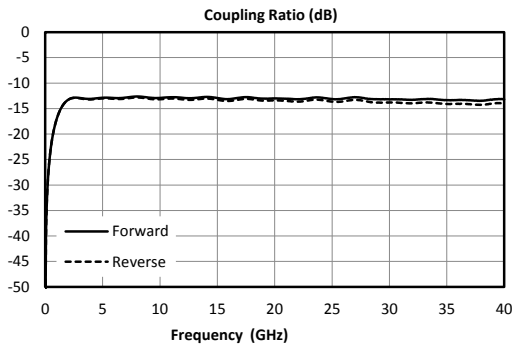
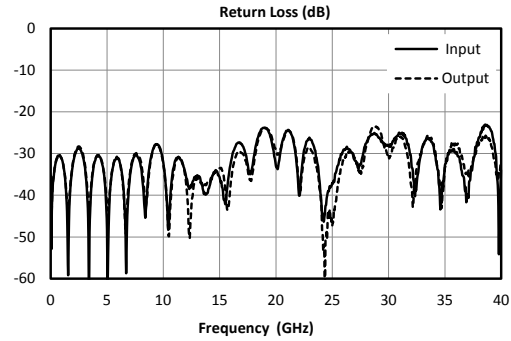
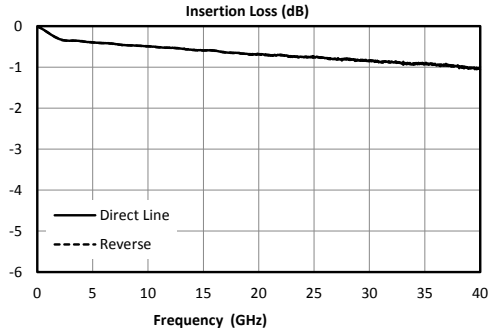

⁸ Typical Performance Plots are shown for CE13-0240 measured in 50Ω environment.

3.4.2 Performance Over Temperature

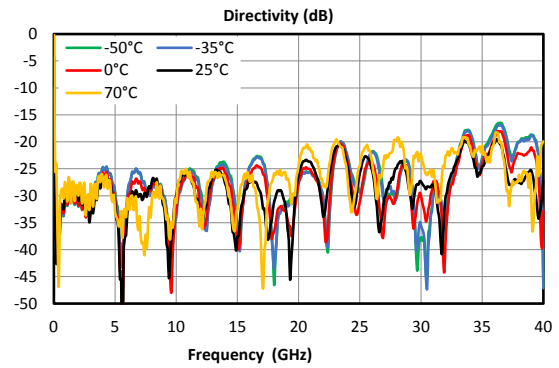
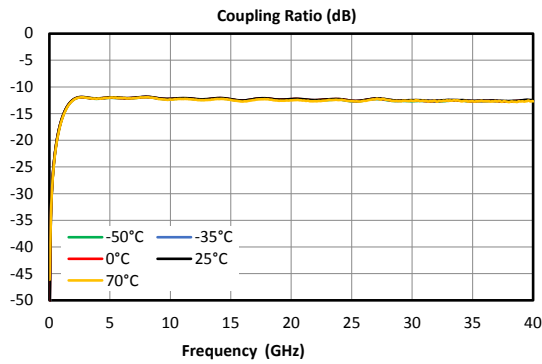
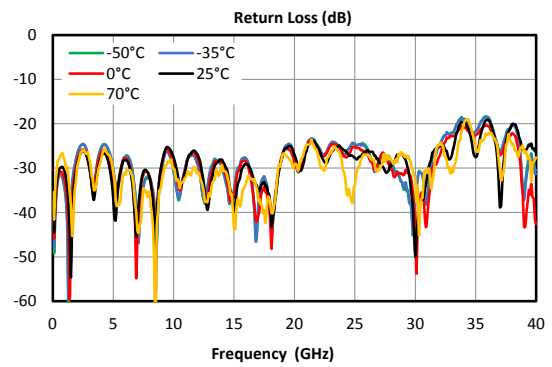
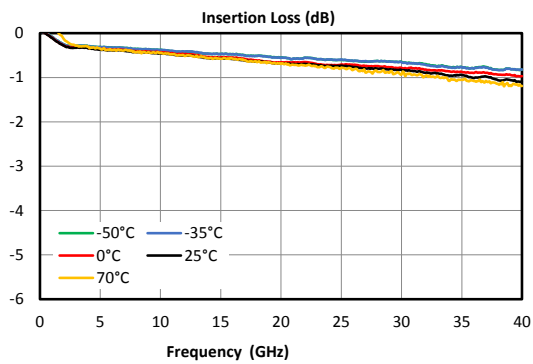

3.4.3 Terminated Return Loss and Directivity

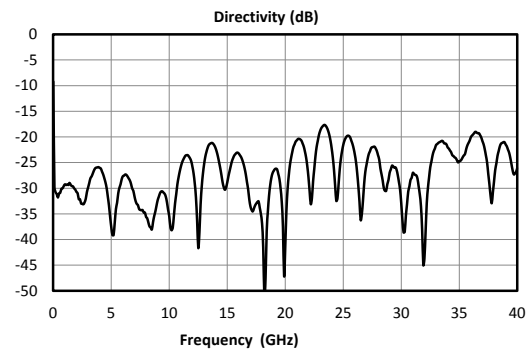
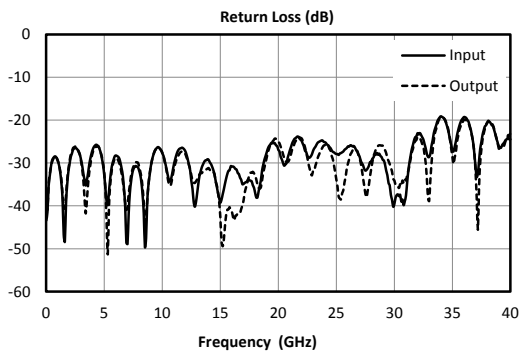

4 Mechanical Data

4.1 Connectorized Module Outline Drawing CE13-0240

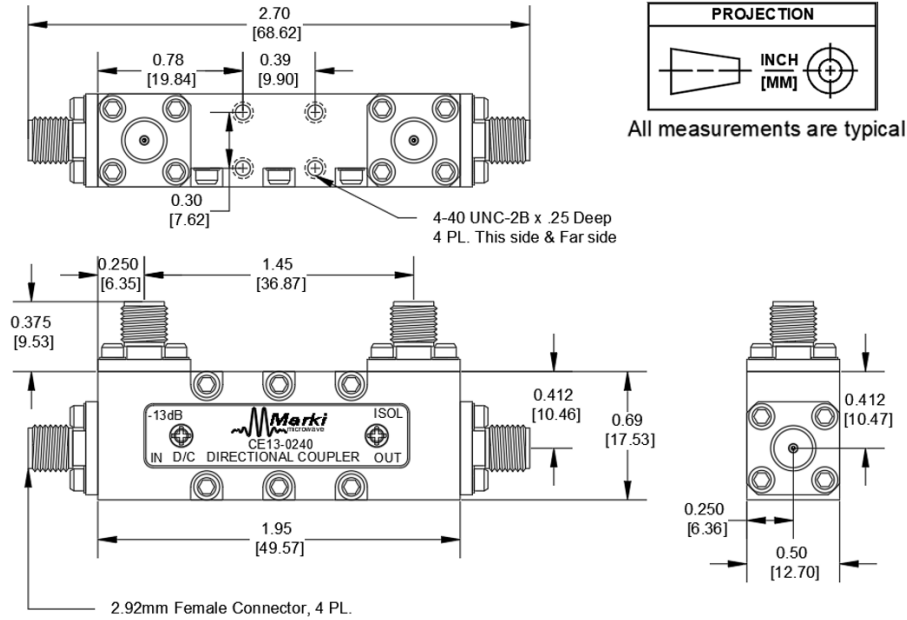

4.2 Connectorized Module Outline Drawing CE13-0240T

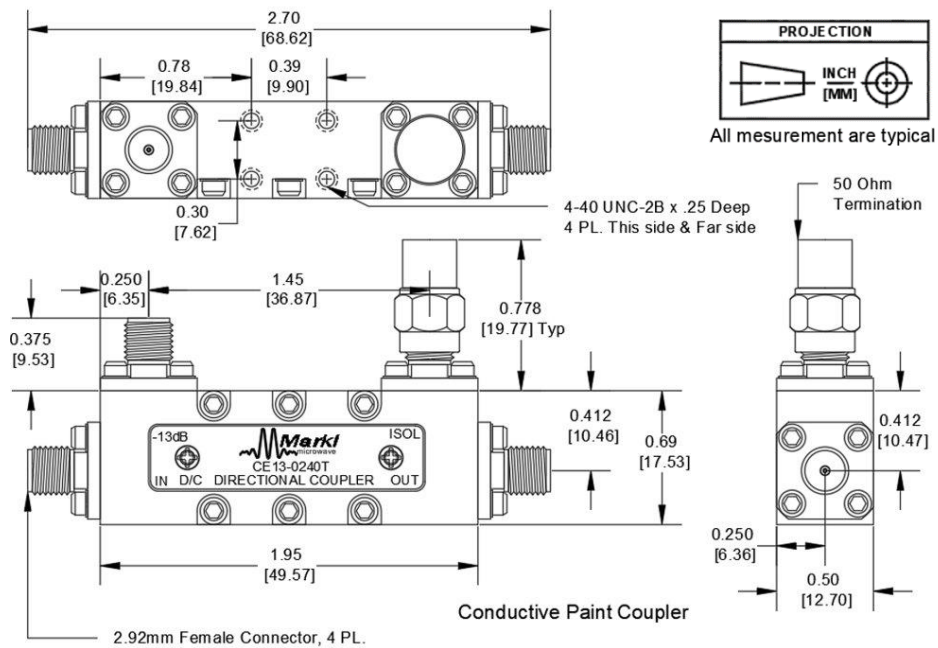

Marki Microwave reserves the right to make changes to the product(s) or information contained herein without notice.

Marki Microwave makes no warranty, representation, or guarantee regarding the suitability of its products for any particular purpose, nor does Marki Microwave assume any liability whatsoever arising out of the use or application of any product.

© Marki Microwave, Inc.

www.markimicrowave.com