

Elite 2-20 GHz Directional Coupler

CE13-0220T

1 Device Overview

1.1 General Description

The CE13-0220T is a next generation broadband 2GHz to 20GHz, 13dB directional coupler from the Marki Elite Series. Conductive paint is applied to all Elite Series products to reduce EMI/RFI leakage and susceptibility. The CE13-0220T offers the best directivity, return loss, and coupling accuracy available on the market. Available as a three port directional coupler with included 50Ω termination on the isolated port, the CE13-0220T is an exceptional choice for broadband return loss measurements, power leveling, and signal monitoring applications. Sophisticated neural network design techniques combined with deep circuit knowledge and triplate stripline construction allow the Marki Elite Series of Couplers to provide superior performance to all other directional couplers available.



Module

1.2 Features

- Broadband Performance
- Excellent Coupling Flatness
- High Directivity
- Low VSWR
- Conductive paint minimizes RF leakage
- [CE13-0220T.S3P](#)
- [Microwave Power Dividers & Couplers App Note](#)

1.3 Functional Block Diagram

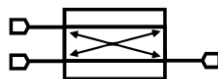

1.4 Part Ordering Options¹

Part Number	Description	Green Status	Product Lifecycle	Export Classification
CE13-0220T	Connectorized module; 50Ω termination included ²	RoHS	Active	EAR99

¹ Refer to our [website](#) for a list of definitions for terminology presented in this table.

² Default configurations has 2.92mm female connectors on all ports. Consult factory for other connector options.

Table of Contents

1	Device Overview	1	3.1	Absolute Maximum Ratings.....	4
1.1	General Description	1	3.2	Package Information.....	4
1.2	Features	1	3.3	Electrical Specifications	4
1.3	Functional Block Diagram	1	3.4	Typical Performance Plots	5
1.4	Part Ordering Options.....	1	3.4.1	Insertion Loss, Return Loss, Coupled Port Power, and Directivity	5
2	Port Configurations and Functions	3	4	Mechanical Data	6
2.1	Port Diagram	3	4.1	Connectorized Module Outline Drawing CE13-0220T	6
2.2	Port Functions	3			
3	Specifications	4			

Revision History

Revision Code	Revision Date	Comment
-	April 2022	Datasheet Initial Release

2 Port Configurations and Functions

2.1 Port Diagram

A side view of the CE13-0220T package outline drawing is shown below. The CE13-0220T has input and output ports given in Port Functions. The CE13-0220T can be used in the forward direction by configuring the coupler with the input signal into port 1, using port 2 for coupled port, and port 3 for output port.

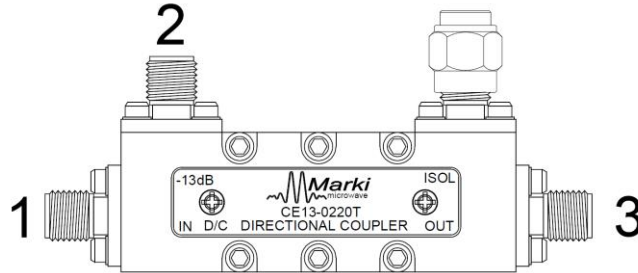

2.2 Port Functions

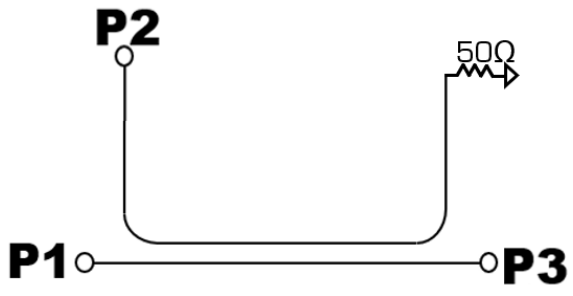
Port	Function	Description	Equivalent Circuit
Port 1	Forward Power Input And Reflected Power Output	The input port is DC short to the output port and open coupled port.	
Port 2	Coupled	The coupled port is DC open to the input and output ports.	
Port 3	Forward Power Output And Reflected Power Input	The output port is DC short to the input port and open coupled port.	

3 Specifications

3.1 Absolute Maximum Ratings

The Absolute Maximum Ratings indicate limits beyond which damage may occur to the device. If these limits are exceeded, the device may be inoperable or have a reduced lifetime.

Parameter	Maximum Rating	Units
Power Handling, at any Port	20	W
Operating Temperature	TBD	°C
Storage Temperature	TBD	°C

3.2 Package Information

Parameter	Details	Rating
ESD	Human Body Model (HBM), per MIL-STD-750, Method 1020	N/A

3.3 Electrical Specifications

The electrical specifications apply for configuration A at $T_A=+25^{\circ}\text{C}$ in a 50Ω system.

Min and Max limits are guaranteed at $T_A=+25^{\circ}\text{C}$.

Parameter	Frequency (GHz)	Min	Typ.	Max
Average Coupling Factor (dB)	2-20	12.5	13	13.5
Coupling Loss (dB) ³	2-20	.2	.22	.25
Direct Line Insertion Loss (dB)	DC-20		.60	1.0
Excess Insertion Loss (dB) ⁴	DC-20		.35	.75
Amplitude Flatness (dB) ⁵	2-20		$\pm .15$	$\pm .40$
Maximum Coupling Deviation (dB)	2-20		$\pm .50$	± 1.00
Standard Directivity (dB)	2-20	19	28	
IL Corrected Directivity (dB) ⁶	2-20	20	30	
Pass Band Return Loss (dB)	DC-20	20	30	
Pass Band VSWR	DC-20		1.07	1.22
Impedance (Ω)			50	

³ Coupling loss based on average coupling factor – visit our [website](#) to learn more.

⁴ Excess Insertion Loss = (Input Port to Output Port Insertion Loss) – Coupling Loss.

⁵ Amplitude Flatness = Median value of ABS(Measured Coupling Power – Average Coupling Factor).

⁶ IL Corrected Directivity = Directivity + Insertion Loss.

3.4 Typical Performance Plots

3.4.1 Insertion Loss, Return Loss, Coupled Port Power, and Directivity

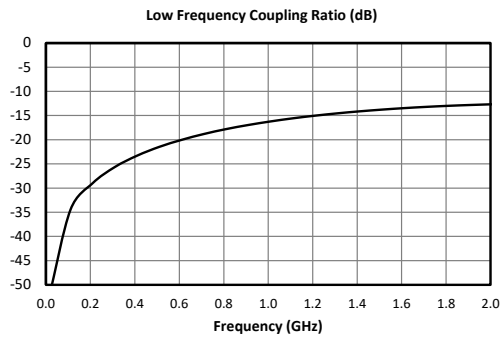
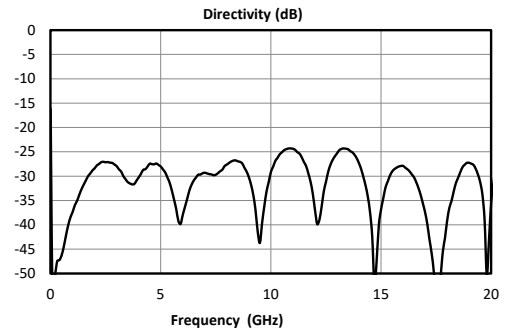
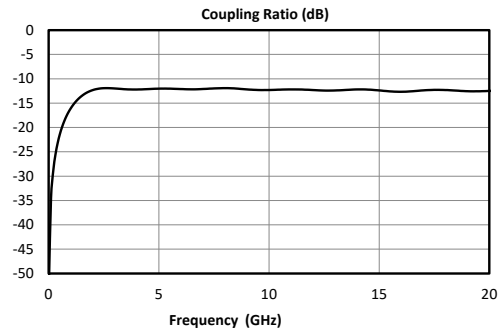
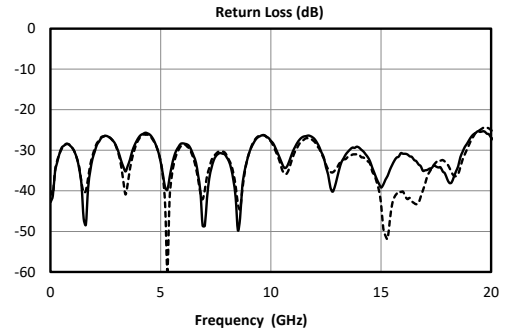
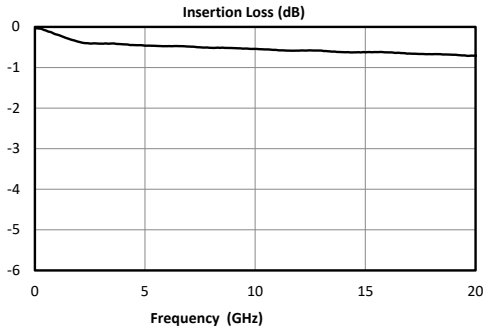

4 Mechanical Data

4.1 Connectorized Module Outline Drawing CE13-0220T

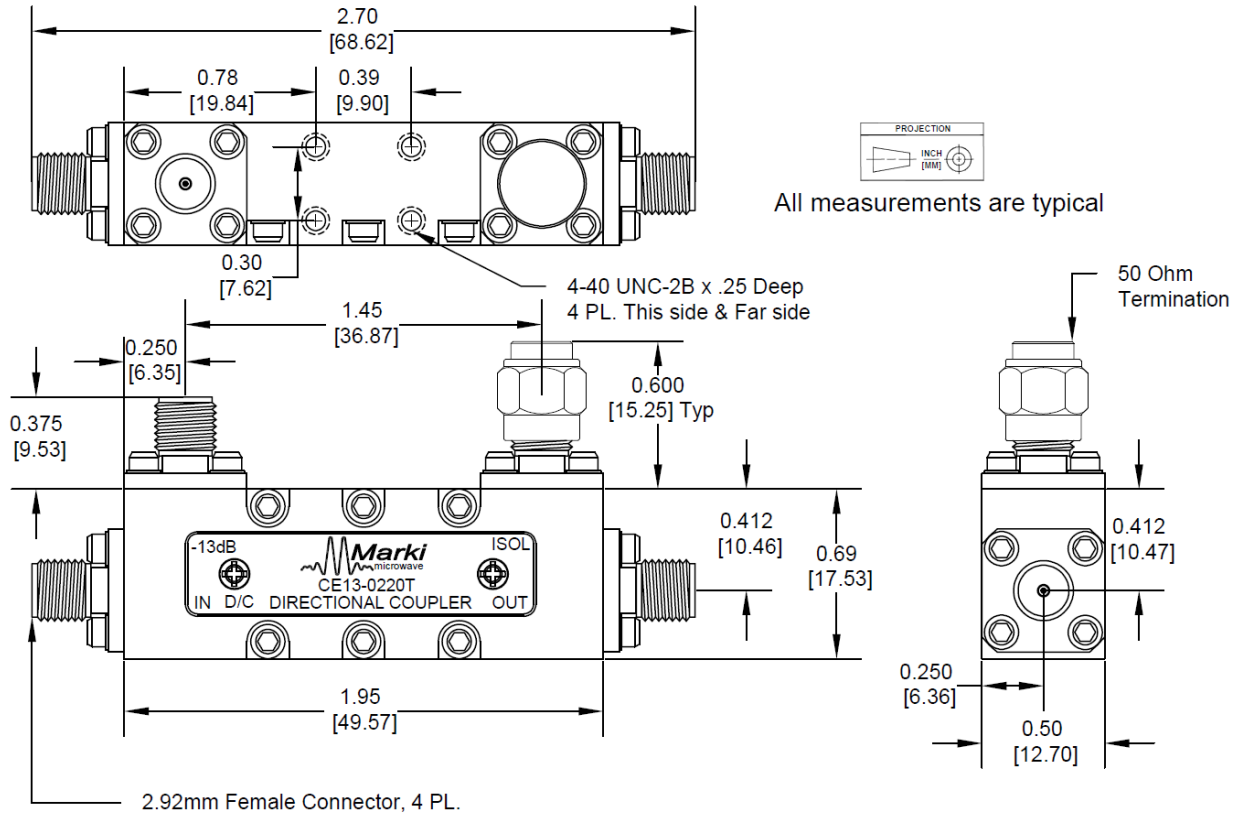

Marki Microwave reserves the right to make changes to the product(s) or information contained herein without notice.

Marki Microwave makes no warranty, representation, or guarantee regarding the suitability of its products for any particular purpose, nor does Marki Microwave assume any liability whatsoever arising out of the use or application of any product.

© Marki Microwave, Inc.

www.markimicrowave.com