

## LEAD-FREE / RoHS-COMPLIANT

### HIGH POWER BIAS TEE

**BTN2-0050**

The BTN2-0050 is constructed using a custom-made, resonance-free conical inductor to achieve extremely broadband performance. By minimizing the overall inductor size and using proprietary packaging techniques, the BTN2-0050 is a superior option in terms of performance, reliability and ease-of-use when compared to cumbersome user-designed bias tees employing off-the-shelf conical inductors. The extremely low cutoff and resonance free operation makes the BTN2-0050 suitable for biasing amplifiers, lasers, and modulators driven with high frequency data patterns.



#### Features

- Broadband: 3 MHz to 50 GHz
- Low Insertion Loss
- High Power
- Non-Resonant
- Compact Size

**Electrical Specifications** - Specifications guaranteed from -55 to +100°C, measured in a 50Ω system.

Parameter	Frequency Range	Min	Typ	Max
Insertion Loss (dB)	10 MHz-50 GHz		1.5	2.5
	3-10 MHz		2	
DC Port Isolation (dB)	3 MHz -1 GHz		50	
	1-50 GHz		30	
Return Loss (dB)	3 MHz-50 GHz		13	
RF Power (W)				5
DC Current (A)				2
DC Voltage (V)				50
DC Resistance (Ω)				0.3
Inductance (uH)				4.7
Capacitance (nF)				100
Weight (g)				10
Risetime /Falltime (ps) <sup>1</sup>				10

<sup>1</sup>Specified as 90%/10%. Calculated from  $\tau_{bl}^2 = (\tau_{out}^2 - \tau_{in}^2)$

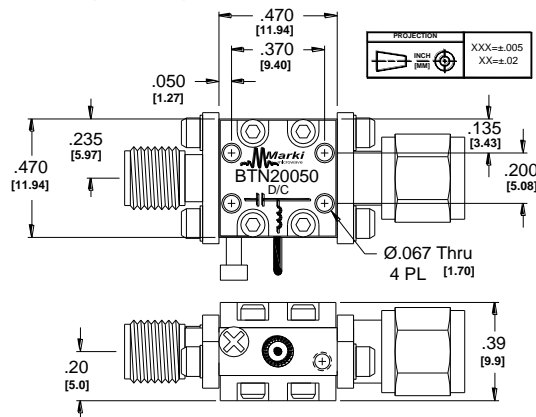

**Schematic**

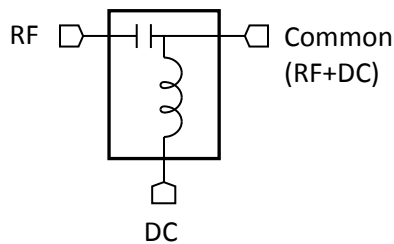

**Application Examples**

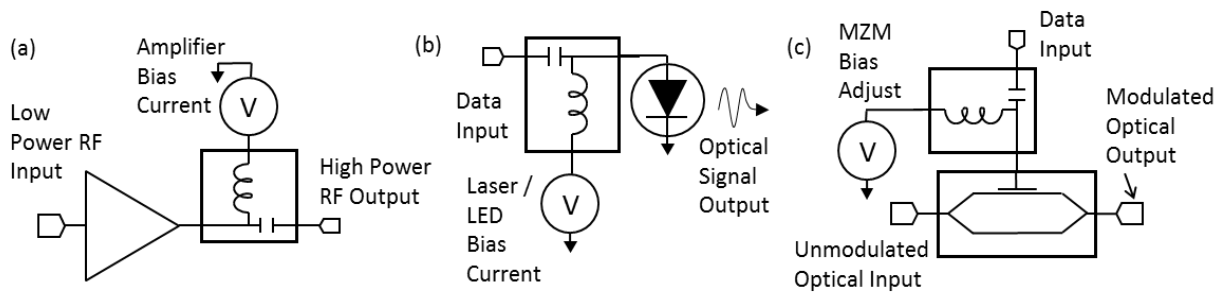

Fig. 1. Example Schematics of a) Broadband Microwave Amplifier Biasing, b) Laser/LED Biasing for Data Communication and c) Mach-Zender Modulator Biasing for Data Communication

**Typical Performance**

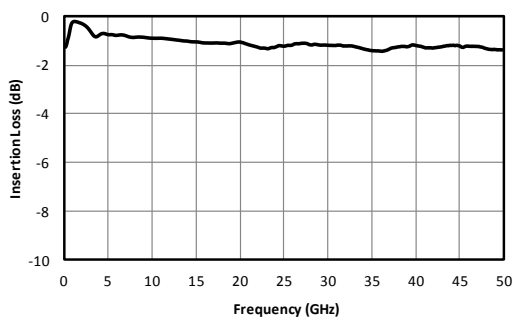

Fig. 2. RF insertion loss.

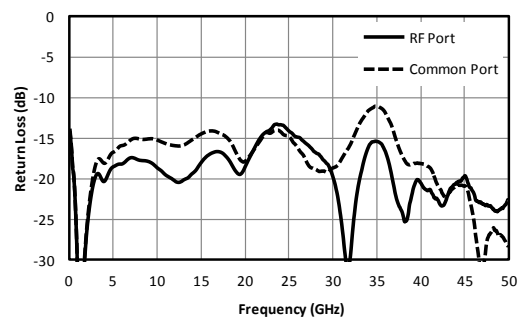

Fig. 3. Return loss.

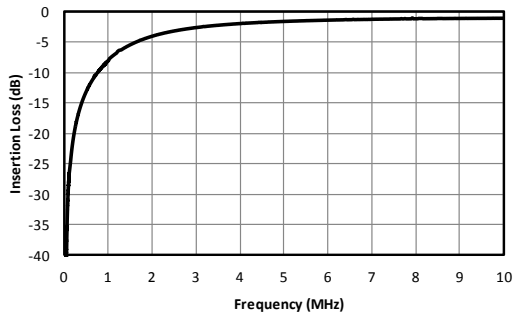

Fig. 4. Low frequency RF response.

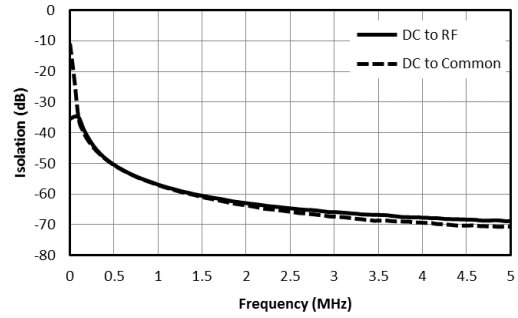

Fig. 5. Low frequency isolation.

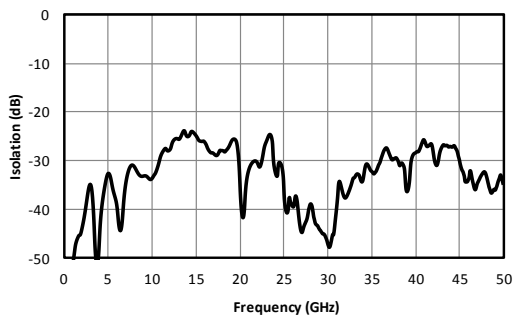

Fig. 6. DC-RF isolation.

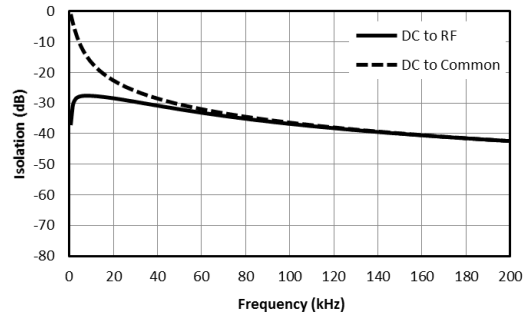

Fig. 7. Near DC isolation

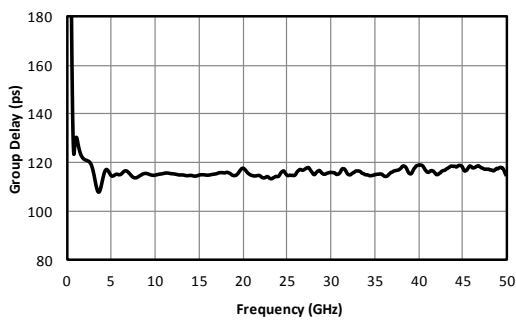

Fig. 8. Group delay.

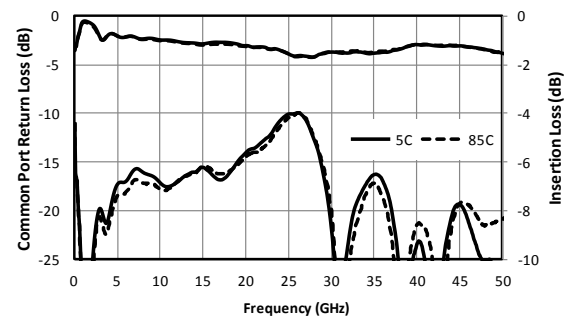

Fig. 9. Performance over temperature

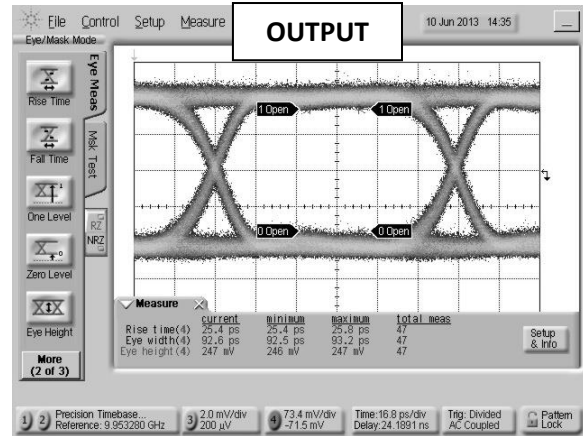
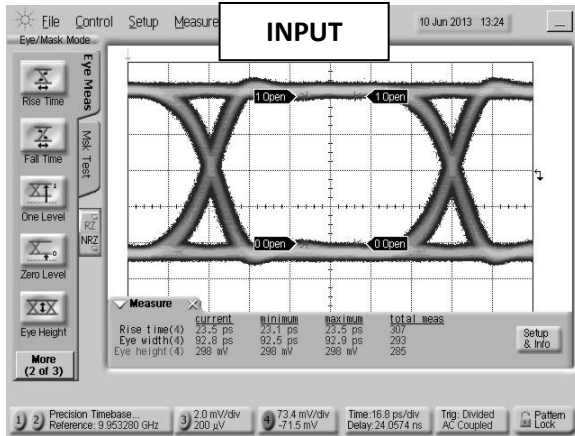

Fig. 7. Oscilloscope measurements of the BTN2-0050 with a 10Gb/s PRBS pattern. Eye diagrams are taken with a 2<sup>31</sup>-1 PRBS input demonstrating minimal eye distortion/closure afforded by the extremely low frequency operation of the bias tee.

Model Number	Description
BTN2-0050	3 MHz to 50 GHz High Power Bias Tee with 2.4 mm connectors <sup>1</sup> , <b>LEAD-FREE/RoHS COMPLIANT</b>

<sup>1</sup>Consult factory for other connector options.

**Revision History**

Revision code	Revision Date	Comment
B	September 2019	RoHS Compliant Assembly

Marki Microwave reserves the right to make changes to the product(s) or information contained herein without notice. Marki Microwave makes no warranty, representation or guarantee regarding the suitability of its products for any particular purpose, nor does Marki Microwave assume any liability whatsoever arising out of the use of or application of any product.