

HIGH POWER BIAS TEE

BTN2-0026

The BTN2-0026 is constructed using a custom-made, resonance-free conical inductor to achieve extremely broadband performance. By minimizing the overall inductor size and using proprietary packaging techniques, the BTN2-0026 is a superior option in terms of performance, reliability and ease-of-use when compared to cumbersome user-designed bias tees employing off-the-shelf conical inductors. The extremely low cutoff and resonance free operation makes the BTN2-0026 suitable for biasing amplifiers, lasers, and modulators driven with high frequency data patterns.



Features

- Broadband: 3 MHz to 26.5 GHz
- Low Insertion Loss
- High Power
- Non-Resonant
- Compact Size

Electrical Specifications - Specifications guaranteed from -55 to +100°C, measured in a 50Ω system.

Parameter	Frequency Range	Min	Typ	Max
Insertion Loss (dB)	10 MHz-26.5 GHz		1	2
	3-10 MHz		2	
DC Port Isolation (dB)	3 MHz -1 GHz		50	
	1-26.5 GHz		30	
Return Loss (dB)	3 MHz-26.5 GHz		14	
RF Power (W)				10
DC Current (A)				2
DC Voltage (V)				50
DC Resistance (Ω)			0.3	
Risetime /Falltime (ps) ¹			10	

¹Specified as 90%/10%. Calculated from $\tau_{bit}^2 = (\tau_{out}^2 - \tau_{in}^2)$

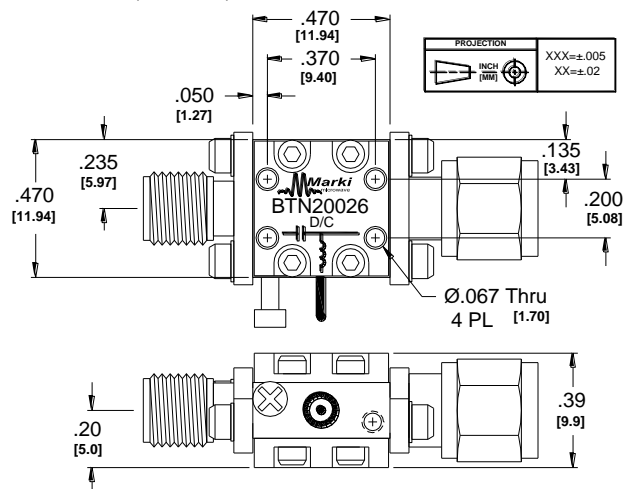

Schematic

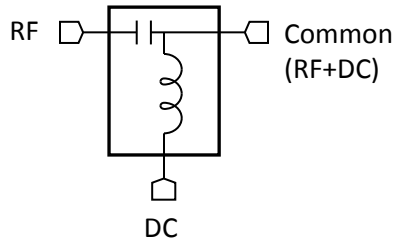

Application Examples

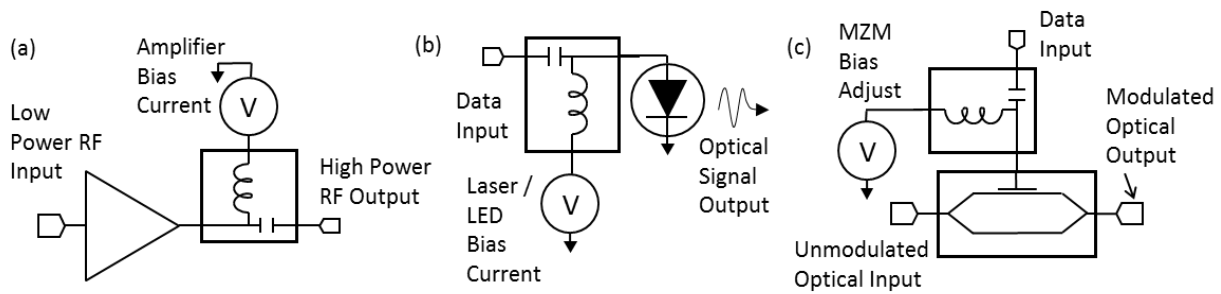

Fig. 1. Example Schematics of a) Broadband Microwave Amplifier Biasing, b) Laser/LED Biasing for Data Communication and c) Mach-Zender Modulator Biasing for Data Communication

Typical Performance

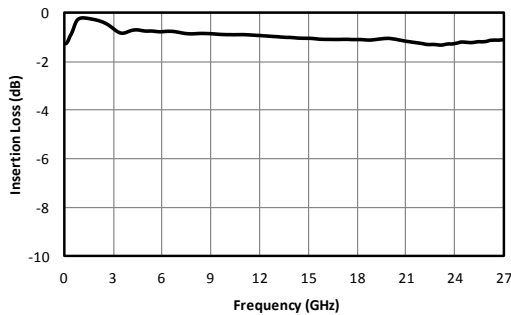

Fig. 2. RF insertion loss.

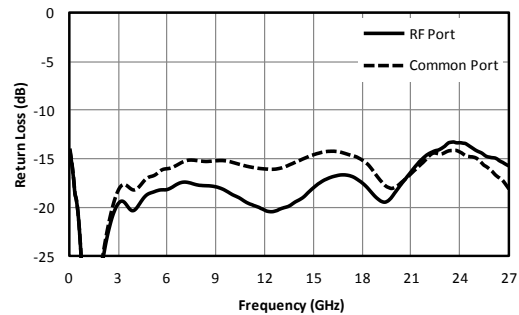

Fig. 3. Return loss.

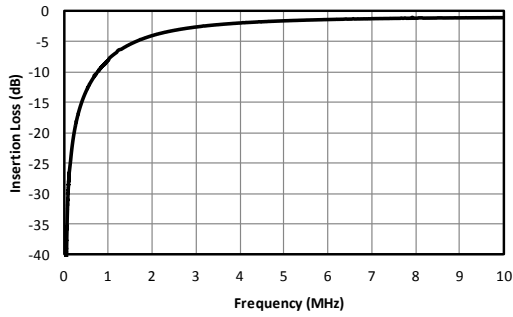

Fig. 4. Low frequency RF response.

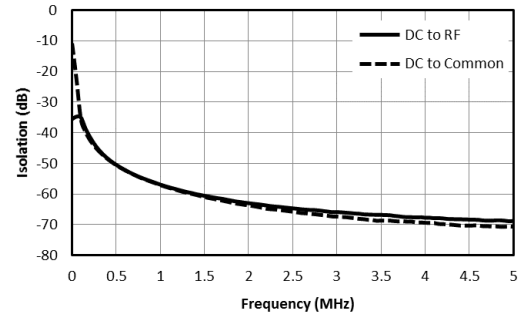

Fig. 5. Low frequency isolation.

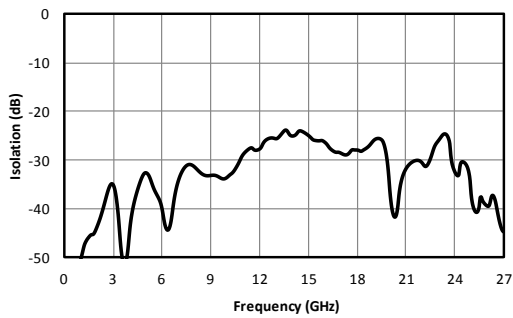

Fig. 6. DC-RF isolation.

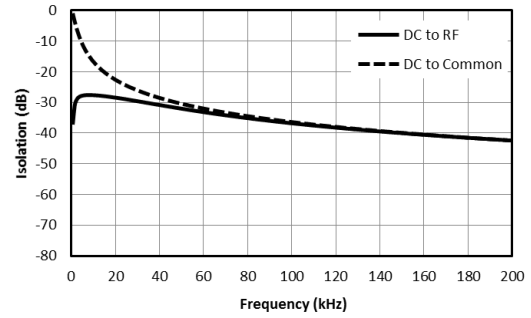

Fig. 7. Near DC isolation

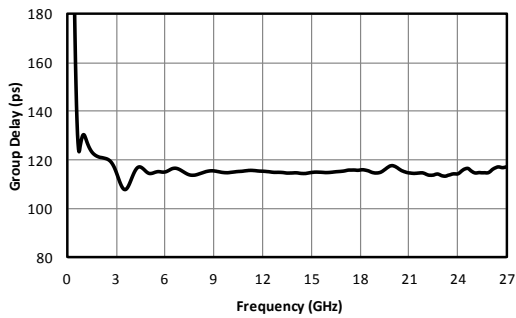

Fig. 8. Group delay.

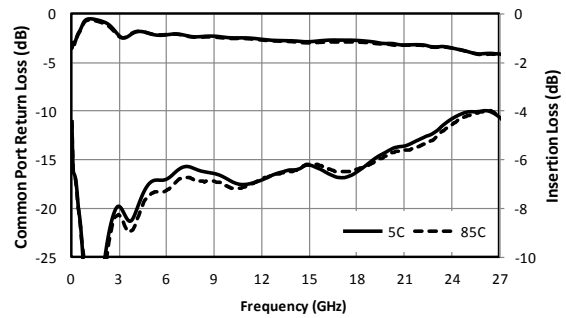

Fig. 9. Performance over temperature

HIGH POWER BIAS TEE

BTN2-0026

Page 4

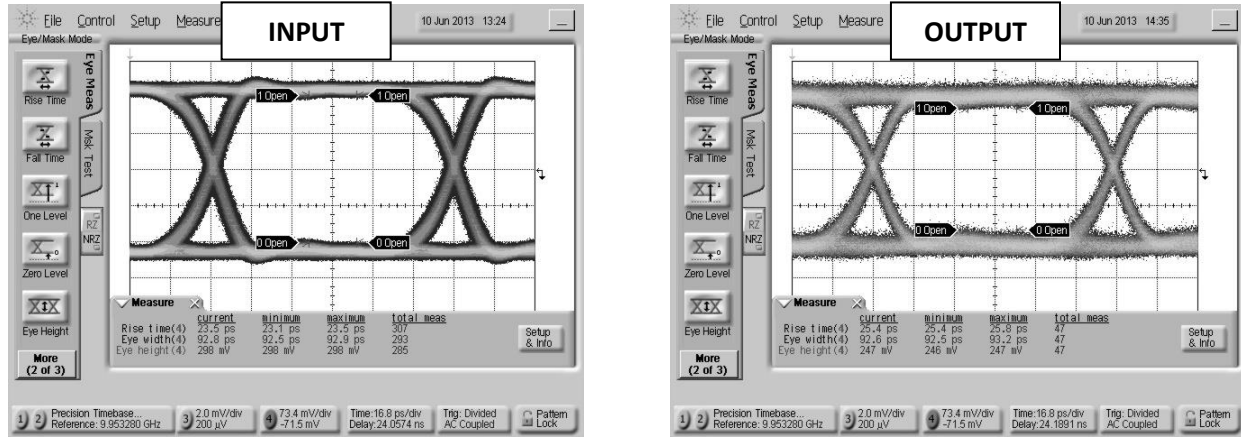

Fig. 7. Oscilloscope measurements of the BTN2-0026 with a 10Gb/s PRBS pattern. Eye diagrams are taken with a 2³¹-1 PRBS input demonstrating minimal eye distortion/closure afforded by the extremely low frequency operation of the bias tee.

Model Number	Description
BTN2-0026	3 MHz to 26.5 GHz High Power Bias Tee with SMA connectors ¹

¹Consult factory for other connector options.

Revision History

Revision code	Revision Date	Comment
-	June 2013	Datasheet initial Release
A	January 2019	Corrected Isolation plots

Marki Microwave reserves the right to make changes to the product(s) or information contained herein without notice. Marki Microwave makes no warranty, representation or guarantee regarding the suitability of its products for any particular purpose, nor does Marki Microwave assume any liability whatsoever arising out of the use of or application of any product.