

HIGH POWER BIAS TEE

BTN2-0018

The BTN2-0018 is constructed using a custom-made, resonance-free conical inductor to achieve extremely broadband performance. By minimizing the overall inductor size and using proprietary packaging techniques, the BTN2-0018 is a superior option in terms of performance, reliability and ease-of-use when compared to cumbersome user-designed bias tees employing off-the-shelf conical inductors. The extremely low cutoff and resonance free operation makes the BTN2-0018 suitable for biasing amplifiers, lasers, and modulators driven with high frequency data patterns.



Features

- Broadband: 3 MHz to 18 GHz
- Low Insertion Loss
- High Power
- Non-Resonant
- Compact Size

Electrical Specifications - Specifications guaranteed from -55 to +100°C, measured in a 50Ω system.

| Parameter | Frequency Range | Min | Typ | Max |
|--------------------------------------|-----------------|-----|-----|-----|
| Insertion Loss (dB) | 10 MHz-18 GHz | | 0.7 | 1.5 |
| | 3-10 MHz | | 2 | |
| DC Port Isolation (dB) | 3 MHz -1 GHz | | 50 | |
| | 1-18 GHz | | 30 | |
| Return Loss (dB) | 3 MHz-18 GHz | | 16 | |
| RF Power (W) | | | | 10 |
| DC Current (A) | | | | 2 |
| DC Voltage (V) | | | | 50 |
| DC Resistance (Ω) | | | 0.3 | |
| Risetime /Falltime (ps) ¹ | | | 10 | |

¹Specified as 90%/10%. Calculated from $\tau_{bt}^2 = (\tau_{out}^2 - \tau_{in}^2)$

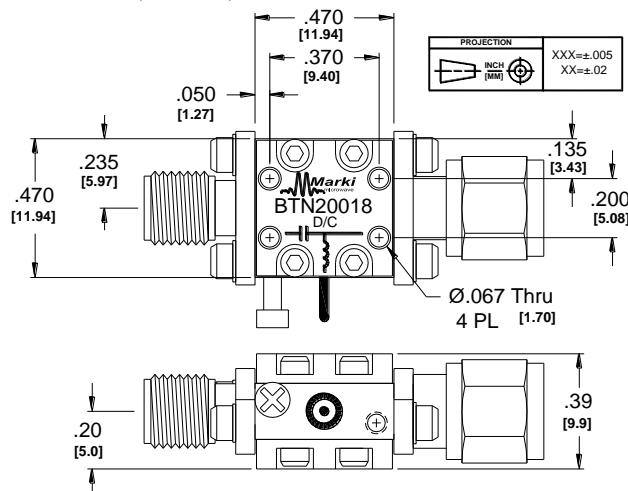

Schematic

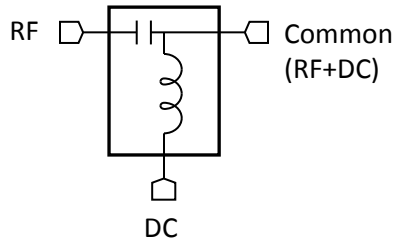

Application Examples

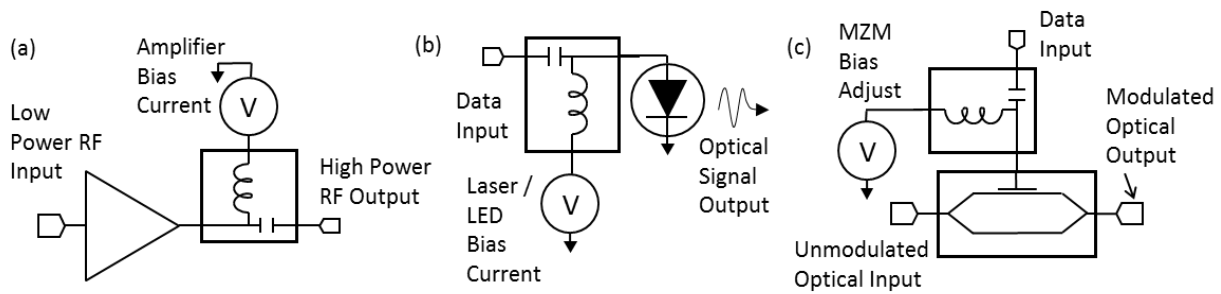

Fig. 1. Example Schematics of a) Broadband Microwave Amplifier Biasing, b) Laser/LED Biasing for Data Communication and c) Mach-Zender Modulator Biasing for Data Communication

Typical Performance

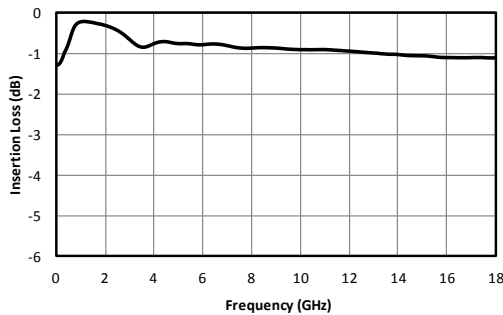

Fig. 2. RF insertion loss.

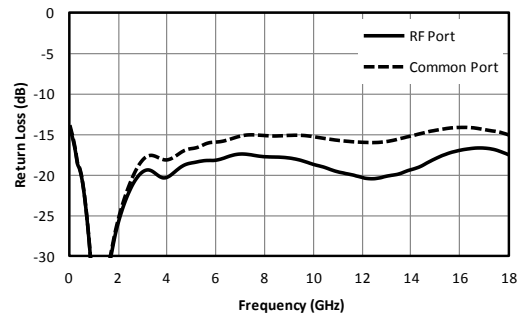

Fig. 3. Return loss.

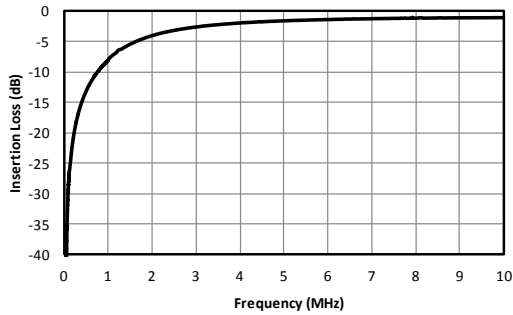

Fig. 4. Low frequency RF response.

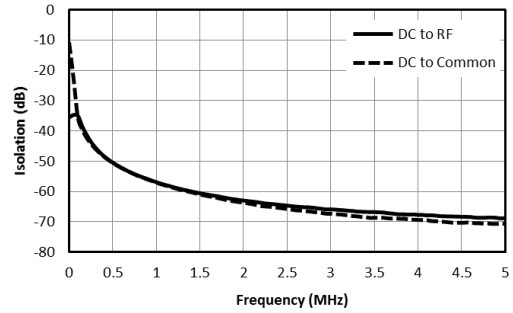

Fig. 5. Low frequency isolation.

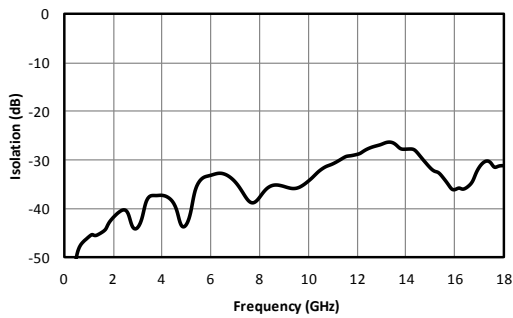

Fig. 6. DC-RF isolation.

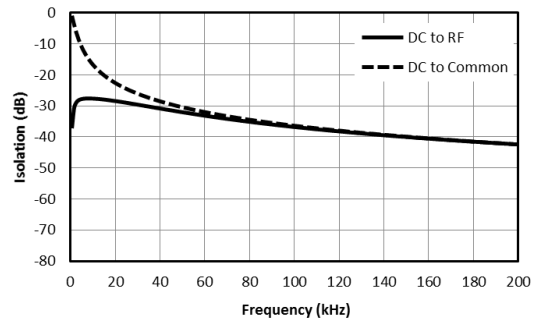

Fig. 7. Near DC isolation

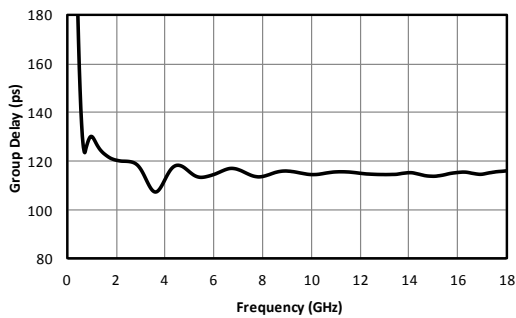

Fig. 8. Group delay.

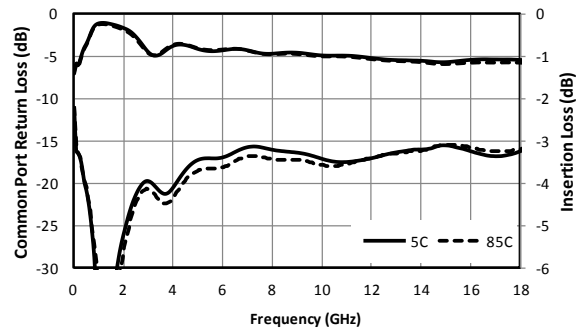

Fig. 9. Performance over temperature

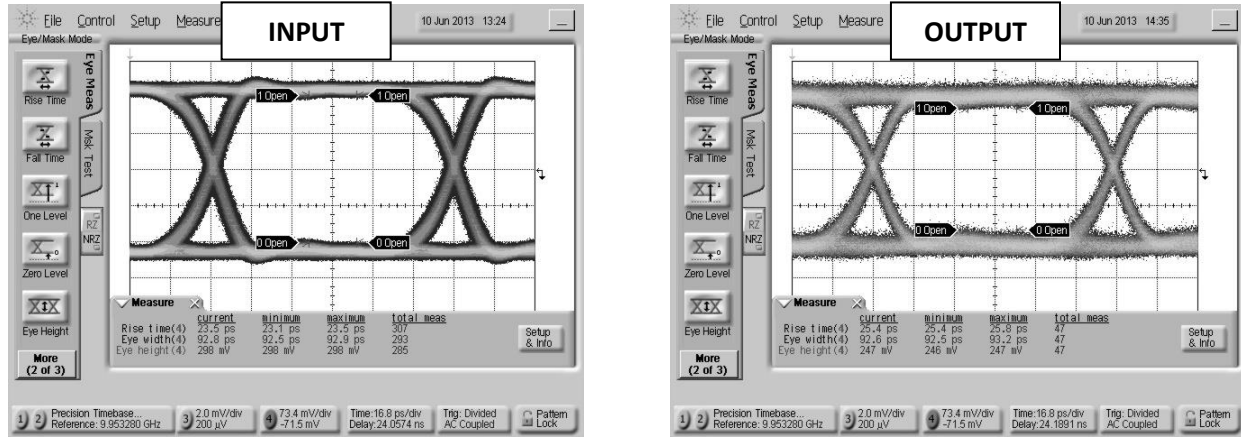

Fig. 7. Oscilloscope measurements of the BTN2-0018 with a 10Gb/s PRBS pattern. Eye diagrams are taken with a 2³¹-1 PRBS input demonstrating minimal eye distortion/closure afforded by the extremely low frequency operation of the bias tee.

| Model Number | Description |
|--------------|--|
| BTN2-0018 | 3 MHz to 18 GHz High Power Bias Tee with SMA connectors ¹ |

¹Consult factory for other connector options.

Revision History

| Revision code | Revision Date | Comment |
|---------------|---------------|---------------------------|
| - | June 2013 | Datasheet initial Release |
| A | January 2019 | Corrected Isolation plots |

Marki Microwave reserves the right to make changes to the product(s) or information contained herein without notice. Marki Microwave makes no warranty, representation or guarantee regarding the suitability of its products for any particular purpose, nor does Marki Microwave assume any liability whatsoever arising out of the use of or application of any product.