

LEAD-FREE / RoHS-COMPLIANT

HIGH POWER BIAS TEE

BTN1-0018

The BTN1-0018 is constructed using a custom-made, resonance-free conical inductor to achieve extremely broadband performance. By minimizing the overall inductor size and using proprietary packaging techniques, the BTN1-0018 is a superior option in terms of performance, reliability and ease-of-use when compared to cumbersome user-designed bias tees employing off-the-shelf conical inductors. The extremely low cutoff and resonance free operation makes the BTN1-0018 suitable for biasing amplifiers, lasers, and modulators driven with high frequency data patterns.



Features

- Broadband: 500 kHz to 18 GHz
- Low Insertion Loss
- High Power
- Non-Resonant
- Compact Size

Electrical Specifications - Specifications guaranteed from -55 to +100°C, measured in a 50Ω system.

Parameter	Frequency Range	Min	Typ	Max
Insertion Loss (dB)	4 MHz-18 GHz		0.7	1.5
	500 kHz-4 MHz		2	
DC Port Isolation (dB)	500 kHz -1 GHz		50	
	1-18 GHz		30	
Return Loss (dB)	500 kHz-18 GHz		16	
RF Power (W)				10
DC Current (A)				1
DC Voltage (V)				50
DC Resistance (Ω)			0.5	
Inductance (uH)			22	
Capacitance (nF)			100	
Weight (g)			10	
Risetime /Falltime (ps) ¹			10	

¹Specified as 90%/10%. Calculated from $\tau_{bt}^2 = (\tau_{out}^2 - \tau_{in}^2)$

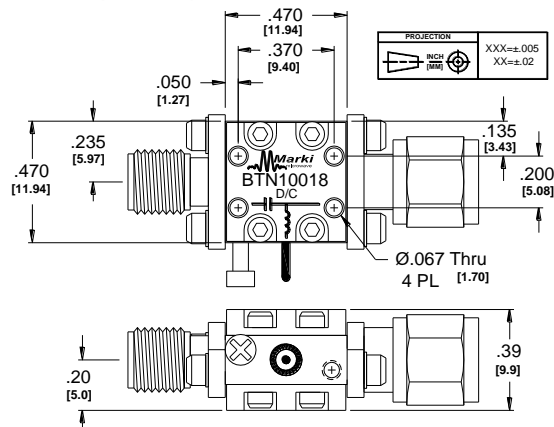

Schematic

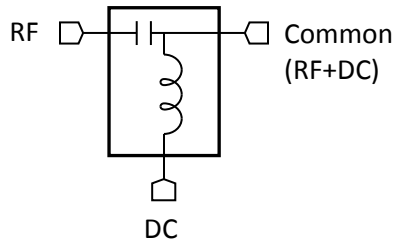

Application Examples

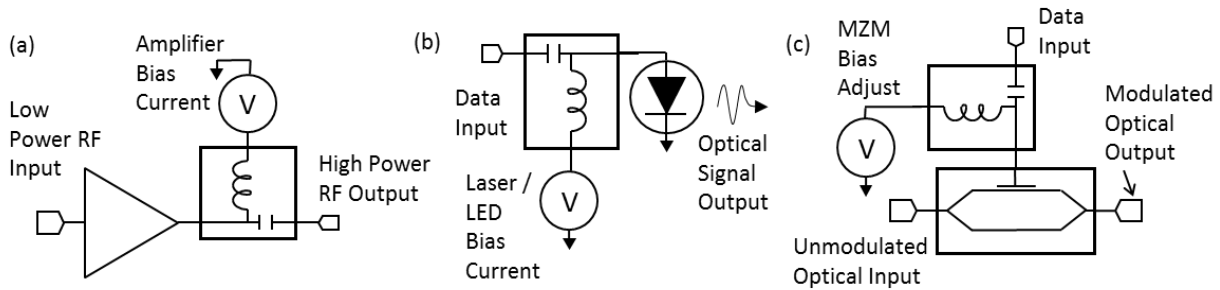

Fig. 1. Example Schematics of a) Broadband Microwave Amplifier Biasing, b) Laser/LED Biasing for Data Communication and c) Mach-Zender Modulator Biasing for Data Communication

Typical Performance

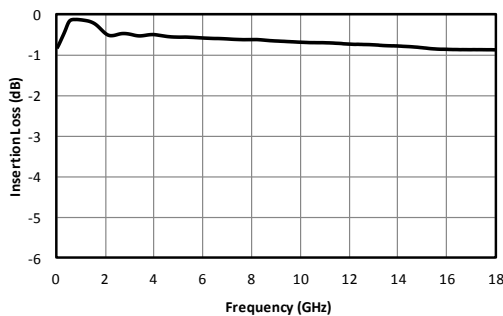

Fig. 2. RF insertion loss.

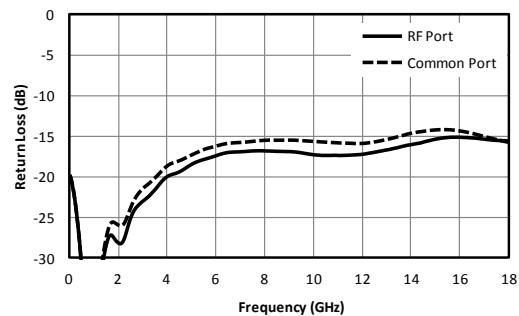

Fig. 3. Return loss.

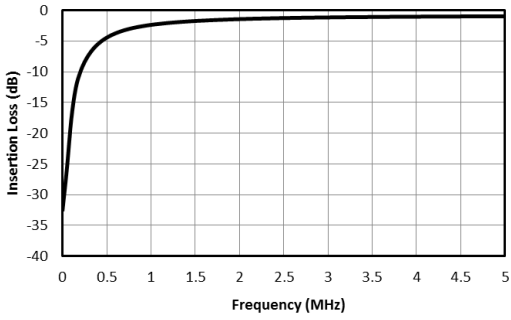

Fig. 4. Low frequency RF response.

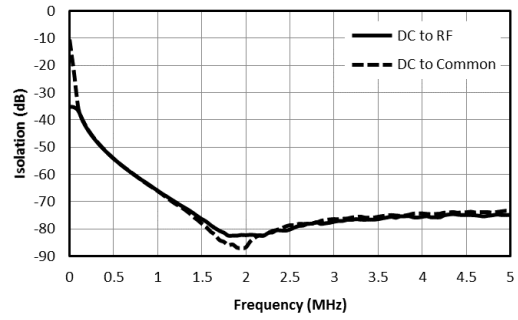

Fig. 5. Low frequency isolation.

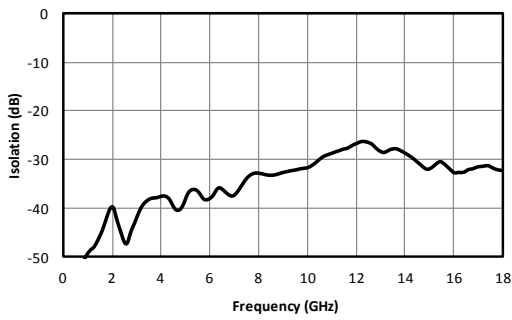

Fig. 6. DC-RF isolation.

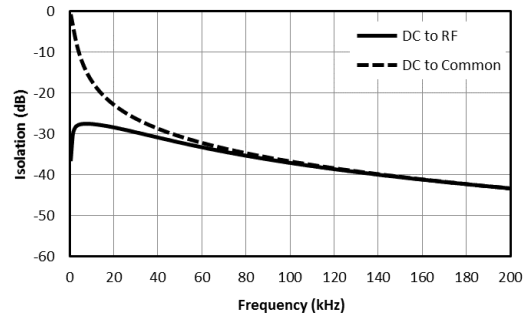

Fig. 7. Near DC isolation

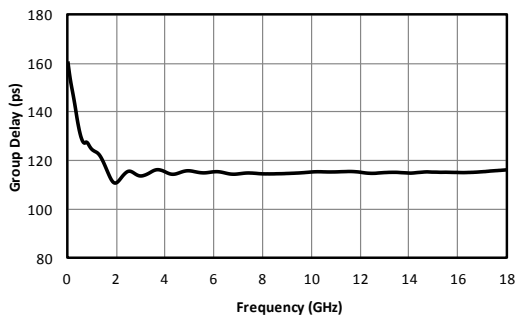

Fig. 8. Group delay.

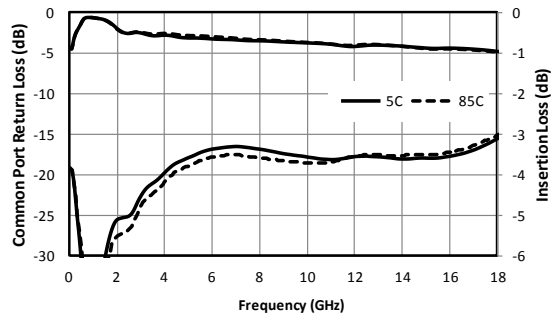

Fig. 9. Performance over temperature

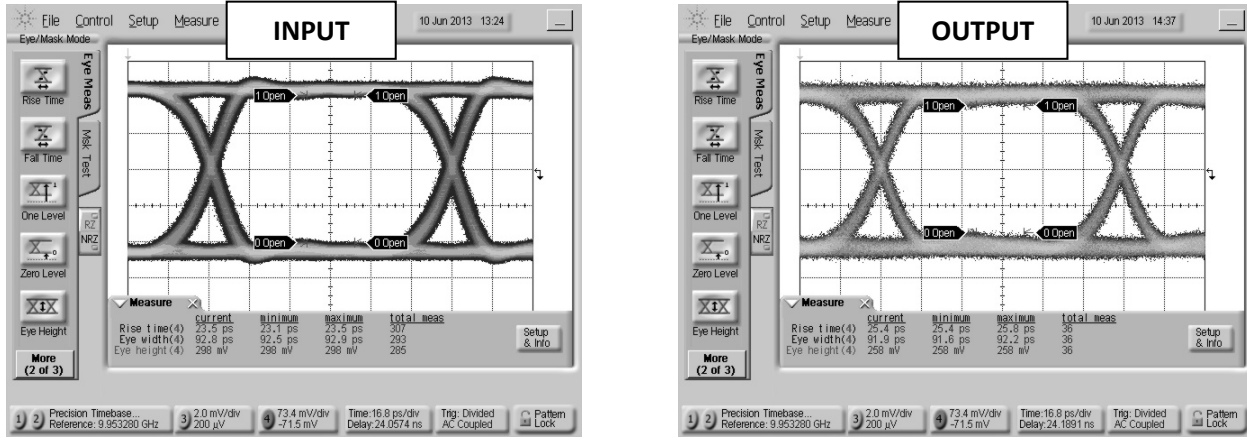

Fig. 10. Oscilloscope measurements of the BTN1-0018 with a 10Gb/s PRBS pattern. Eye diagrams are taken with a $2^{31}-1$ PRBS input demonstrating minimal eye distortion/closure afforded by the extremely low frequency operation of the bias tee.

Model Number	Description
BTN1-0018	500 kHz to 18 GHz High Power Bias Tee with SMA connectors ¹ , LEAD-FREE/ROHS COMPLIANT

¹Consult factory for other connector options.

Marki Microwave reserves the right to make changes to the product(s) or information contained herein without notice. Marki Microwave makes no warranty, representation or guarantee regarding the suitability of its products for any particular purpose, nor does Marki Microwave assume any liability whatsoever arising out of the use of or application of any product.

Revision History

Revision code	Revision Date	Comment
B	May 2020	RoHS Compliant Assembly