



LEAD-FREE / RoHS-COMPLIANT

MINIATURE SURFACE-MOUNT BIAS-TEE

BTL-0012SMG

Features

- Frequency Range: 500 kHz to 12 GHz
- Frequency Range with [External Coil](#): 5 kHz to 12 GHz
- 1 Watt RF Power Handling
- DC Current 500 mA
- Miniature Surface Mount Package
- Lead Free Assembly
- [Reflow Solderable](#)



Electrical Specifications - Specifications guaranteed from -55 to +100°C, measured in a 50-Ohm system

Parameter	Frequency Range	Min	Typ	Max	
Insertion Loss (dB)	500 kHz to 5 MHz		1	6	
	5 MHz to 12 GHz		0.5	1.5	
DC Current (mA)	500 kHz to 12 GHz			500	
DC Resistance (Ohms)			<1.5		
Capacitance (uF)			1		
Inductance (uH)			17		
DC Port Isolation (dB)			35		
DC Voltage Maximum (V)					30
RF Power Maximum (W)					1

Model ¹	Description
BTL-0012SMG-1 BTL-0012SMG-2	500 kHz - 12 GHz Bias Tee, Surface Mount, LEAD-FREE/RoHS COMPLIANT

¹Default is -2 when not specified.

Connectorized test fixtures available. Consult factory.

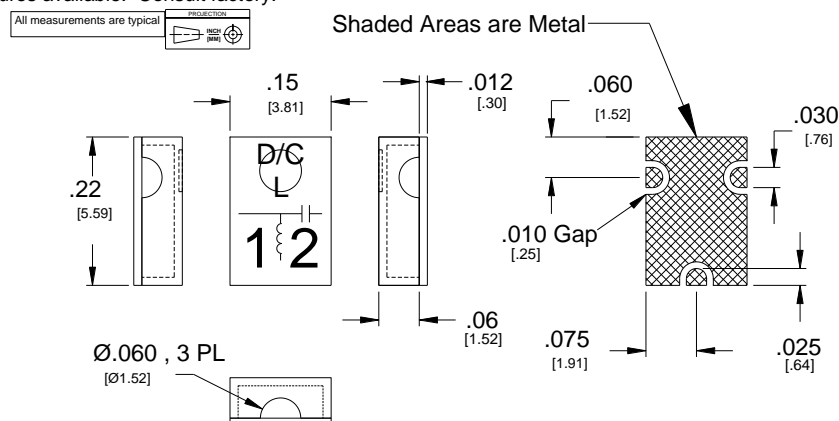

Substrate material is 12-mil thick Rogers 4003, ½ Oz Electrodeposited Cu both sides.
ENIG, Gold 2-8 μ-inches, over solderable electroplated nickel, 100-200 μ-inches per QQ-N-290A

[Click here for suggested PCB layout.](#)

215 Vineyard Court, Morgan Hill, CA 95037 | Ph: 408.778.9952 | Fax 408.778.4300 | sales@markimicrowave.com

Typical Performance

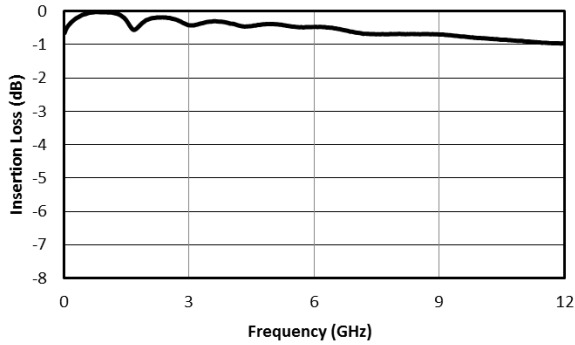

Fig. 1. Insertion loss.

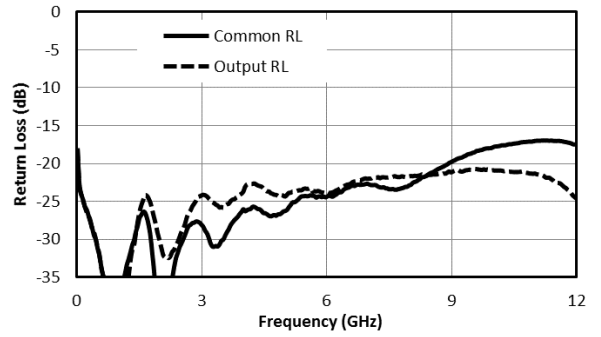

Fig. 2. Return loss

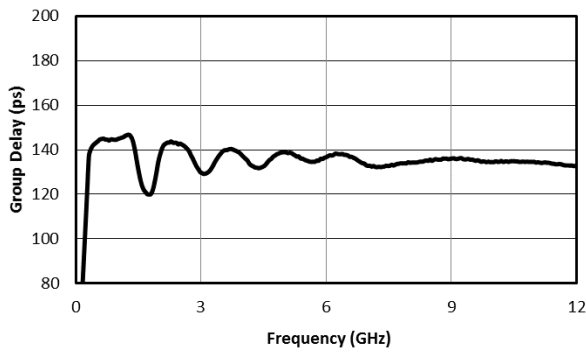

Fig. 3. Group delay

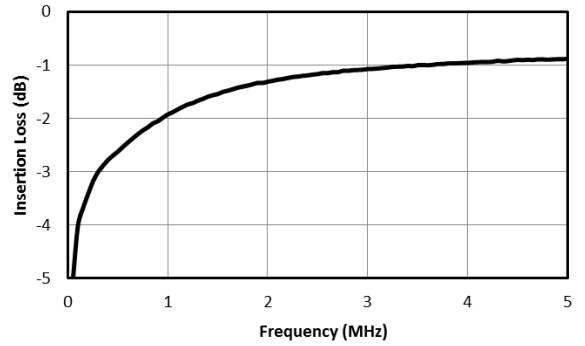

Fig. 4. Low Frequency

Typical Performance vs Bias Current at Low frequencies

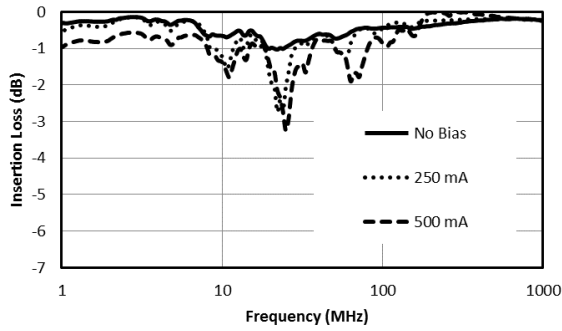

Fig. 5. Insertion loss vs Bias Current.

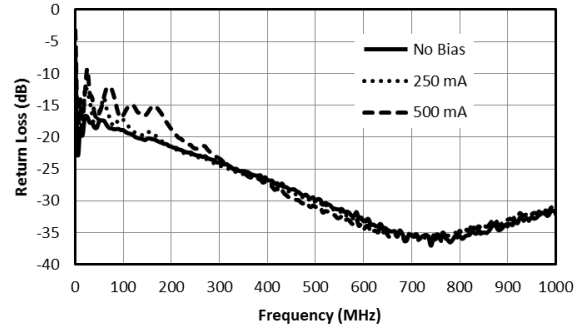

Fig. 6. Common Return Loss vs Bias Current

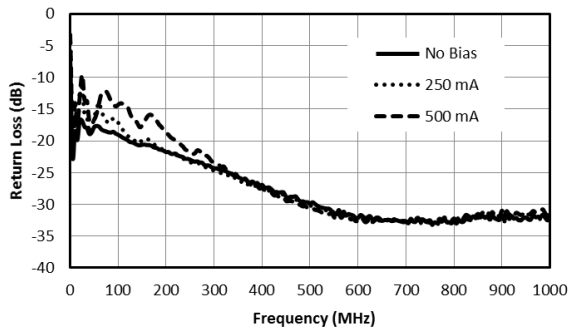

Fig. 7. RF Return Loss vs Bias Current

MINIATURE SURFACE MOUNT BIAS TEE

BTL-0012SMG

Page 4

Port Configuration Option

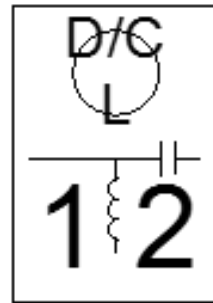
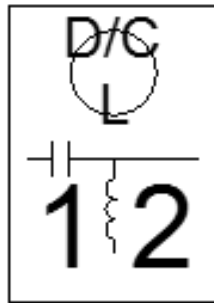

BTL-0012SMG-1

BTL-0012SMG-2

Revision History

Revision code	Revision Date	Comment
-	1/2021	Datasheet Initial Release

Marki Microwave reserves the right to make changes to the product(s) or information contained herein without notice. Marki Microwave makes no warranty, representation, or guarantee regarding the suitability of its products for any particular purpose, nor does Marki Microwave assume any liability whatsoever arising out of the use or application of any product.