

BIAS TEE

BT-0065

The BT-0065 is constructed using a custom-made, resonance-free conical inductor to achieve extremely broadband performance. By minimizing the overall inductor size and using proprietary packaging techniques, the BT-0065 is a superior option in terms of performance, reliability and ease-of-use when compared to cumbersome self-made bias tees employing off-the-shelf conical inductors. The extremely low cutoff and resonance free operation makes the BT-0065 suitable for biasing amplifiers, lasers, and modulators driven with high frequency data patterns.



Features

- Broadband: 4 kHz to 65 GHz
- Low Insertion Loss
- Non-Resonant
- Compact Size

Electrical Specifications - Specifications guaranteed from -55 to +100°C, measured in a 50Ω system.

Parameter	Frequency Range	Min	Typ	Max
Insertion Loss (dB)	4 kHz-65 GHz		1.8	3
DC Port Isolation (dB)			30	
Return Loss (dB)			12	
RF Power (W)				1
DC Current (mA)				500
DC Voltage (V)				30
DC Resistance (Ω)			3	
Risetime/Falltime (ps) ¹			10	

¹Specified as 90%/10%. Calculated from $\tau_{bt}^2 = (\tau_{out}^2 - \tau_{in}^2)$

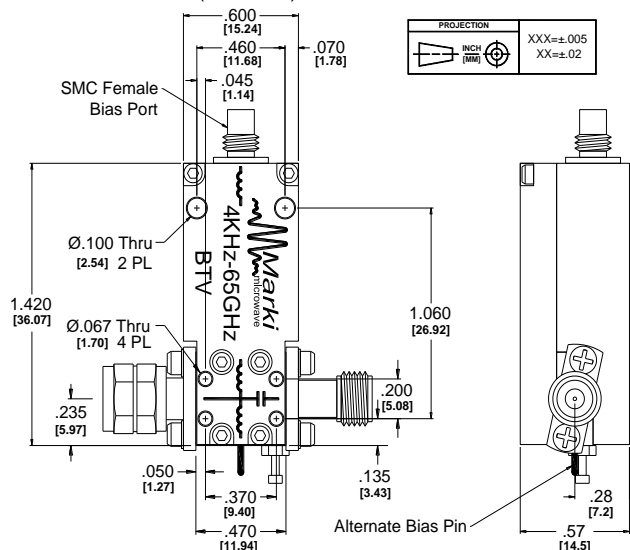

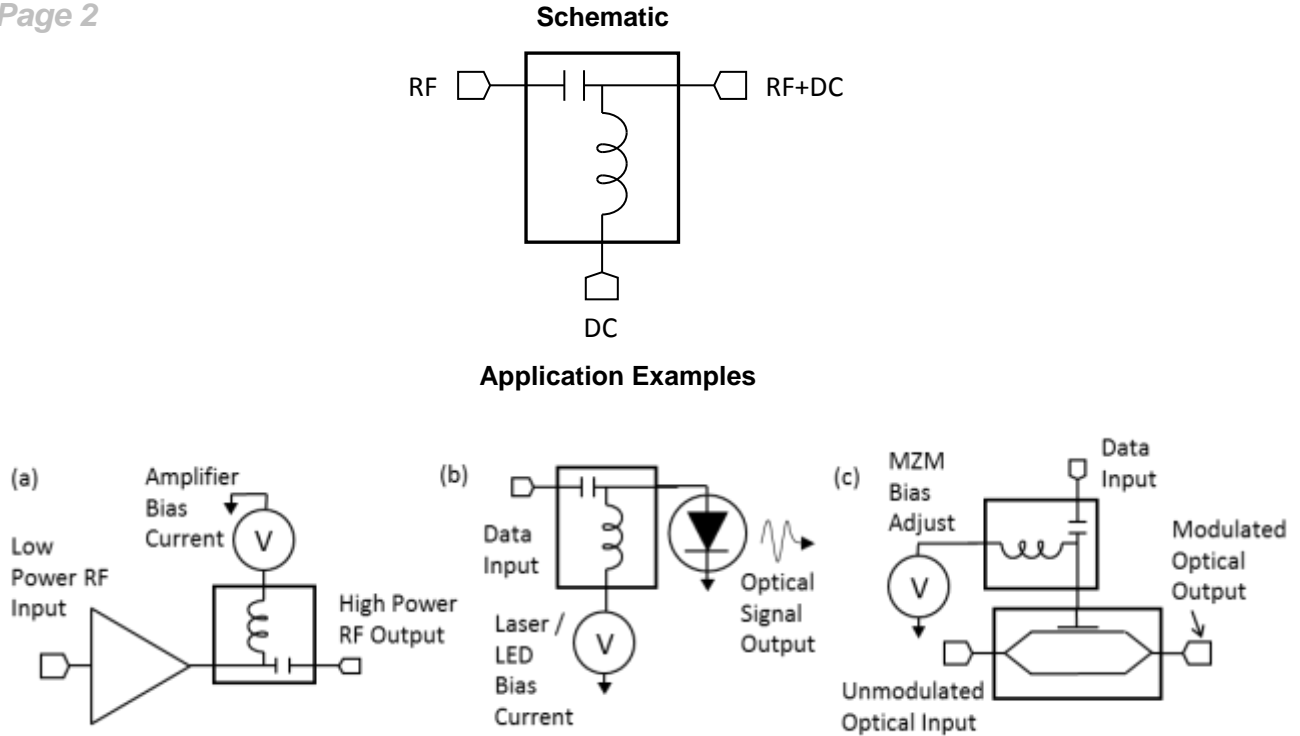

Fig. 1. Example Schematics of a) Broadband Microwave Amplifier Biasing, b) Laser/LED Biasing for Data Communication and c) Mach-Zender Modulator Biasing for Data Communication

Typical Performance

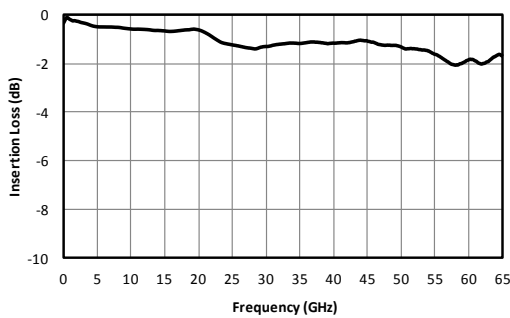

Fig. 2. RF insertion loss.

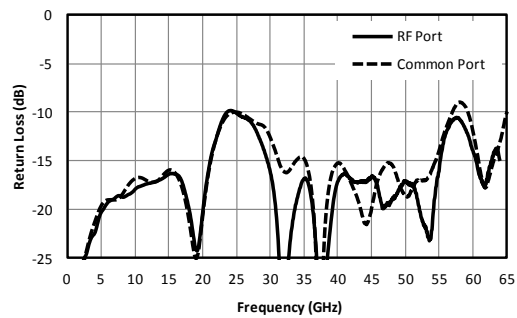

Fig. 3. Return loss.

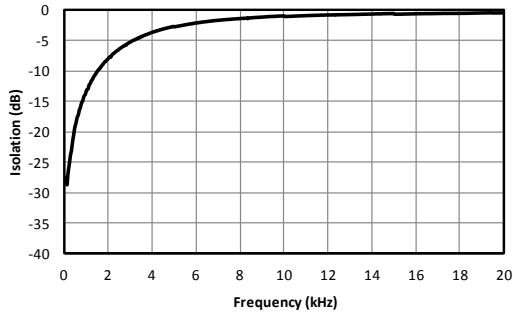

Fig. 4. Low frequency RF response.

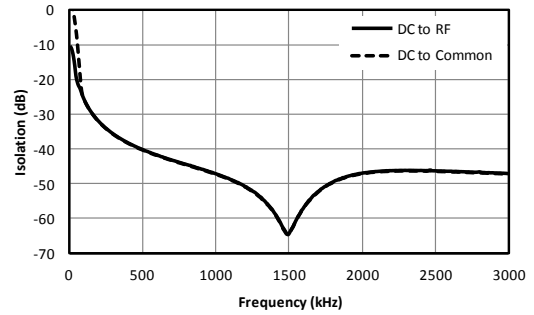

Fig. 5. Low frequency isolation.

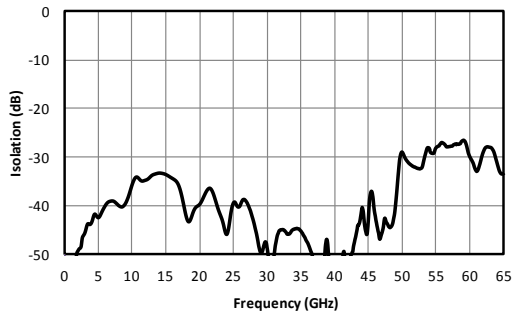

Fig. 6. DC-RF isolation.

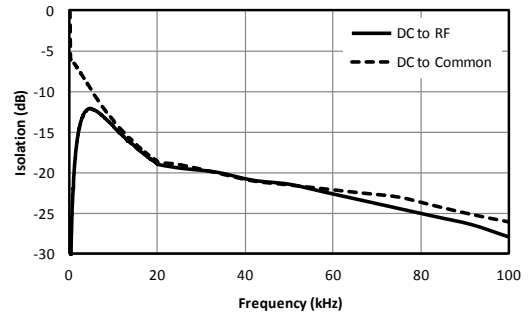

Fig. 7. Near DC isolation

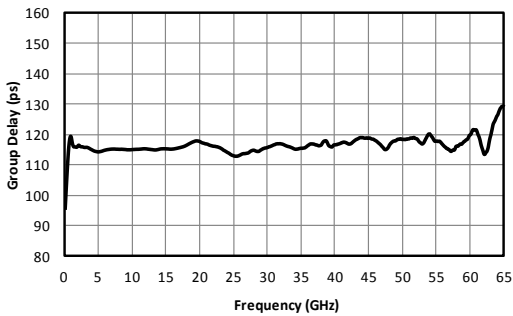

Fig. 8. Group delay.

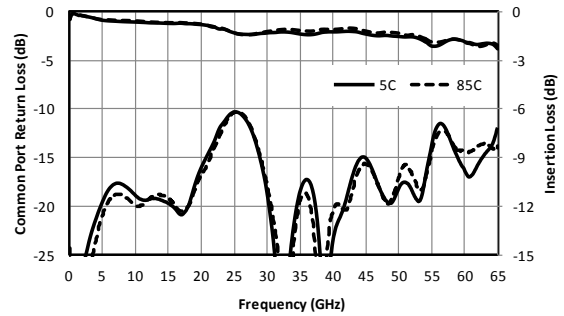

Fig. 9. Performance over temperature

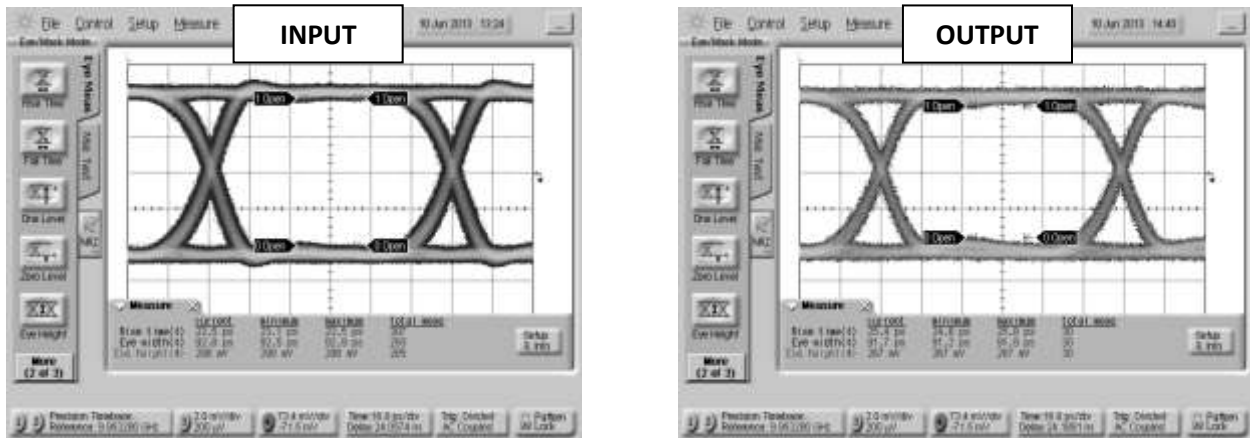

Fig. 7. Oscilloscope measurements of the BT-0065 with a 10Gb/s PRBS pattern. Eye diagrams are taken with a $2^{31}-1$ PRBS input demonstrating minimal eye distortion/closure afforded by the extremely low frequency operation of the bias tee.

Model Number	Description
BT-0065	4 kHz to 65 GHz Bias Tee with 1.85 mm connectors ¹

¹Consult factory for other connector options.

Marki Microwave reserves the right to make changes to the product(s) or information contained herein without notice. Marki Microwave makes no warranty, representation or guarantee regarding the suitability of its products for any particular purpose, nor does Marki Microwave assume any liability whatsoever arising out of the use of or application of any product.