



## LEAD-FREE / RoHS-COMPLIANT

### SURFACE-MOUNT BROADBAND BALUN

### BAL-0416SMG

The BAL-0416SMG is a Surface Mount Microlithic™ balun. As with all Microlithic™ baluns, it features excellent amplitude balance, phase balance, and common mode rejection across a broad bandwidth and in a miniaturized form factor. It has significant isolation, reducing the reflection of unwanted common mode signals. The BAL-0416SMG is a lead free, RoHS compliant package compatible with standard leaded and lead-free solder reflows. SMA connectorized evaluation packages are available. The BAL-0416SMG is an excellent choice for balanced amplifiers, clock distribution, and higher order Nyquist sampling in analog to digital converters



#### Features

- 4 GHz to 16 GHz 1:2 Balun (Balanced to Unbalanced Transformer)
- Transforms 50 Ω Input to 100 Ω Differential (50 Ohm Single) Output
- Tuned for Optimal Phase/Amplitude Balance
- Applications: Analog to Digital Converters, Balanced Receivers, Balanced Amplifiers, Mixers, Clock Distribution, Signal Integrity
- [BAL-0416SMG.s3p](#)

**Electrical Specifications** - Specifications guaranteed from -55 to +100°C, measured in a 50Ω system.

Parameter	Frequency Range	Min	Typ	Max
Insertion Loss as a mode converter (dB) <sup>1</sup>	4 GHz to 16 GHz		3.3	5.5
Nominal Phase Shift (Degrees)			180	
Amplitude Balance (dB)			0.4	1
Phase Balance (Degrees)	4 GHz to 12 GHz		1	5
	12 GHz to 16 GHz		6	15
Common Mode Rejection (dB)	4 GHz to 12 GHz	25	35	
	12 GHz to 16 GHz	15	26	
Isolation (dB)			15	
VSWR			2.5	
Total Input Power (W)				1

<sup>1</sup>Includes fixture losses.

Model Number	Description
BAL-0416SMG	4 GHz to 16 GHz Balun, Surface Mount, <b>LEAD-FREE/RoHS COMPLIANT</b>

**SURFACE-MOUNT BROADBAND BALUN**

**BAL-0416SMG**

Page 2

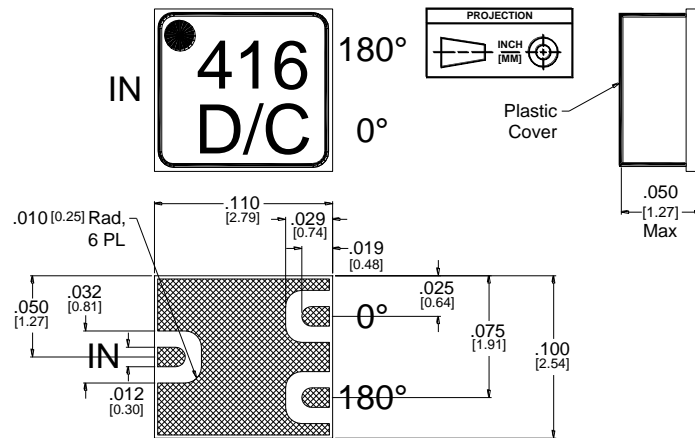

I/O traces and ground plane finish is TiW/NiAu, 0.5 microns Au max over 0.75 - 1.5 microns Ni.  
See [BALSM-ML-PCB](#) for suggested PCB layout.

**Block Diagram**

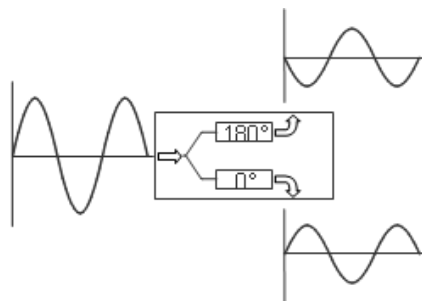

**Single ended to differential**

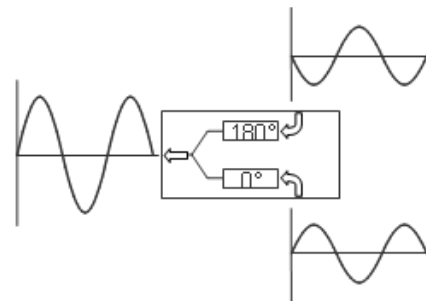

**Differential to single ended**

**Typical Performance Scattering Parameters**

Three port scattering parameters measured as three single-ended 50Ω ports showing relationship between any two ports. For example: S<sub>21</sub> and S<sub>31</sub>, often referred to as insertion loss of a balun, is the output response on ports 2 and 3 with an input stimulus on port 1.

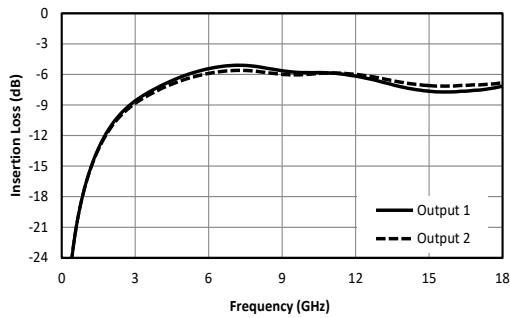

Fig. 1. Common to balanced port insertion loss<sup>1</sup>

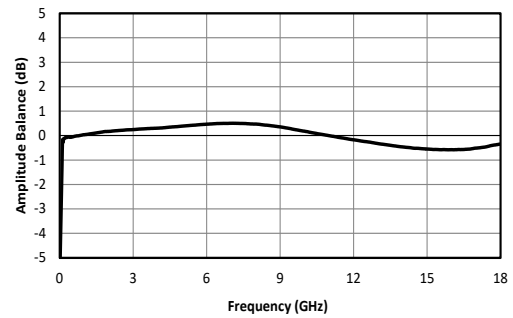

Fig. 2. Amplitude balance between balanced ports.

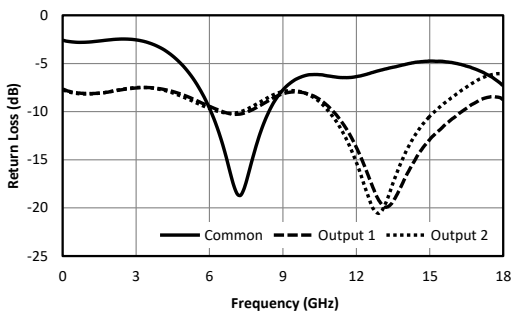

Fig. 3. Return loss for common port and balanced ports.

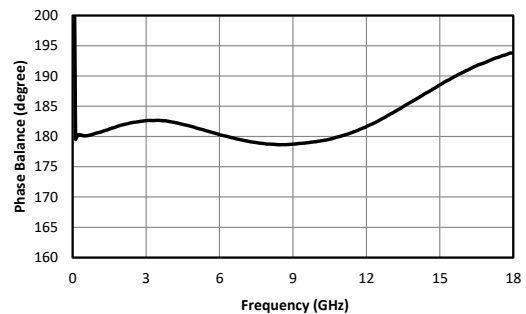

Fig. 4. Phase balance between balanced ports.

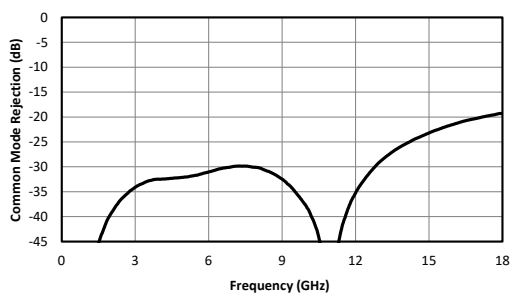

Fig. 5. Common mode rejection

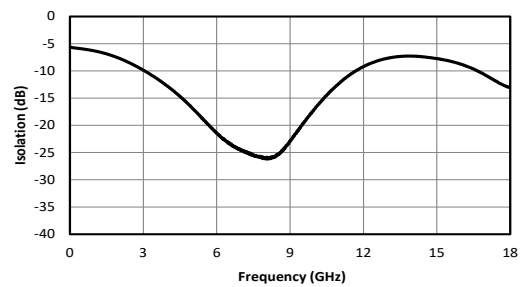

Fig. 6. Balanced port to balanced port isolation

<sup>1</sup>Includes test fixture loss. Results are not de-embedded.

**Mixed Mode Scattering Parameters**

Mixed mode scattering parameters are used to characterize differential circuits. For baluns, this means that the 0° and 180° ports become a single 100Ω differential port and the common port remains the same 50Ω common port. The two-port s-parameters of the balun are then characterized based on differential (d), common mode (c), or single-ended (s) signals. For example: Scs12 is the Common output response given a single ended input.

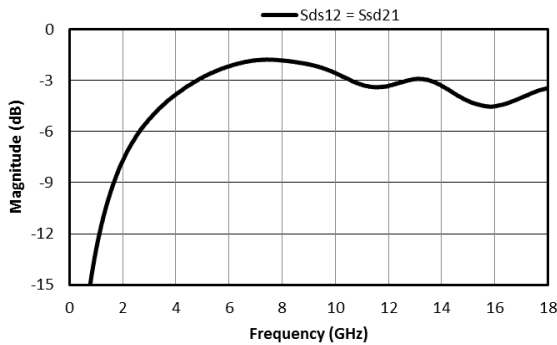

Fig. 7. Insertion loss as a mode converter

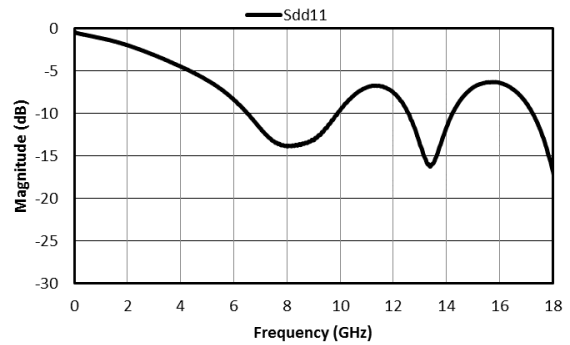

Fig. 8. Differential port return loss

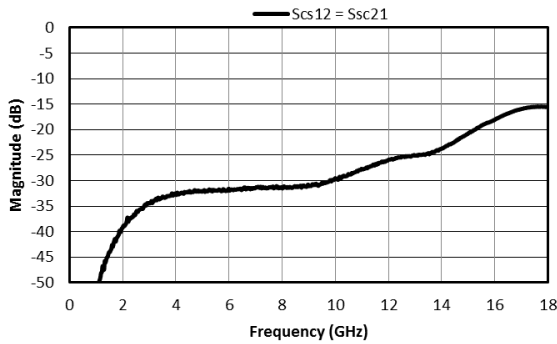

Fig. 9. Insertion loss of a common mode signal

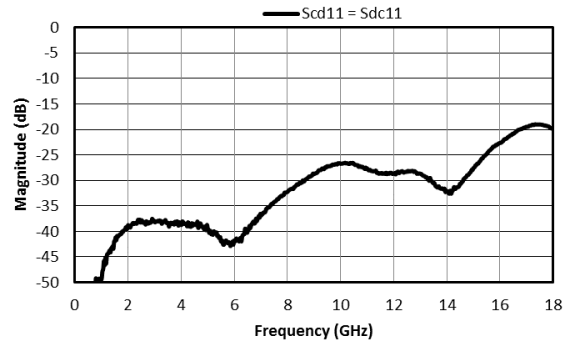

Fig. 10. Reflection converted between differential and common modes

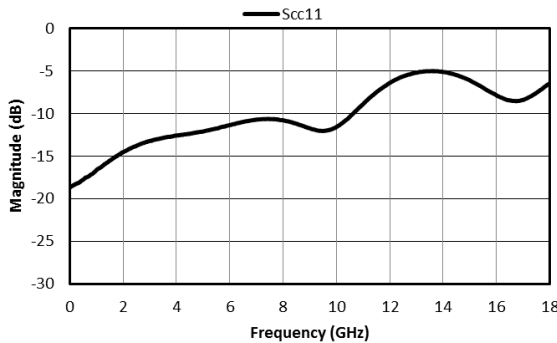

Fig. 11. Return loss of a common mode signal

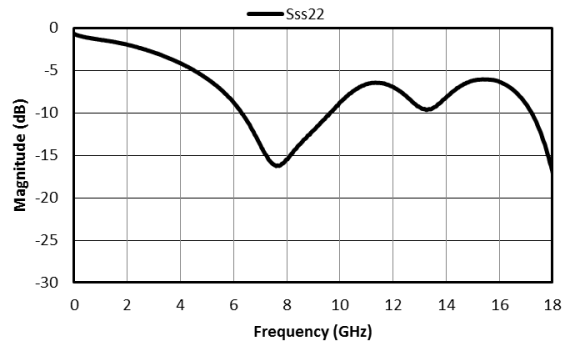

Fig. 12. Unbalanced port return loss

## SURFACE-MOUNT BROADBAND BALUN

**BAL-0416SMG**

Page 5

### DC Interface

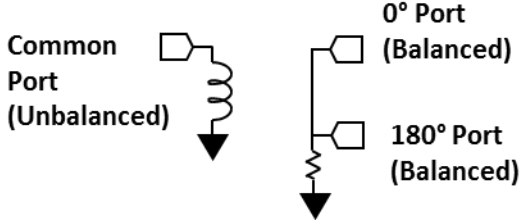
Port	Description	DC Interface Schematic
Common Port (Unbalanced)	The common port is DC short to ground.	
0° Port (Balanced)	The 0° port is DC short to the 180° port and passes through a resistor to ground.	
180° Port (Balanced)	The 180° port is DC short to the 0° port and passes through a resistor to ground.	

### Revision History

Revision code	Revision Date	Comment
-	2014	Datasheet initial Release
A	2016	Typical Performance Plots Updated
B	October 2019	Mixed Mode Scattering Parameters added
C	July 2020	Specs table update
D	October 2020	Specs table update
E	October 2021	Plating spec update

Marki Microwave reserves the right to make changes to the product(s) or information contained herein without notice. Marki Microwave makes no warranty, representation or guarantee regarding the suitability of its products for any particular purpose, nor does Marki Microwave assume any liability whatsoever arising out of the use of or application of any product.