

LEAD-FREE / RoHS-COMPLIANT

Broadband Isolation Balun (300KHz to 50 GHz)

BAL-0050

Page 1

Features

- 300 kHz to 50 GHz Balun (Balanced to Unbalanced Transformer)
- 1:2 Transformer (50 Ω unbalanced, 100 Ω differential/50 Ω balanced port)
- Applications: Analog to Digital Converters, Balanced Receivers, Baseband Digital Modulation, Signal Integrity
- Termination insensitive: Particularly suited to testing poorly matched or non 50 Ω devices or for extending 2 port VNAs for differential testing
- [BAL-0050.s3p](#)

Electrical Specifications - Specifications guaranteed from -55 to +100°C, measured in a 50Ω system.

Parameter	Frequency Range	Min	Typ	Max	
Insertion Loss as a mode converter (dB)	300 kHz to 35 GHz		4.5	6.5	
	35 to 50 GHz		7		
Isolation (dB)	1 to 50 GHz		25		
Nominal Phase Shift (Degrees)	300 kHz to 50 GHz		180		
Amplitude Balance (dB)			0.7	1.4	
Phase Balance (Degrees)			4	10	
Common Mode Rejection (dB)			20	28	
VSWR (Common)				1.5	
VSWR (Output)				1.6	
Group Delay (ps)				520	
RMS Group Delay Ripple (ps)				8	
Risetime /Falltime (ps) ¹				5	
Total Input Power (W)					1
Weight (g)				125	

¹Specified as 80%/20%. Calculated from $\tau_{\text{balun}}^2 = (\tau_{\text{out}}^2 - \tau_{\text{in}}^2)$

Model Number	Description
BAL-0050	300 kHz to 50 GHz Balun with 2.40 mm connectors ¹

¹Default is 2.40 mm female connectors. Consult factory for other connector options.

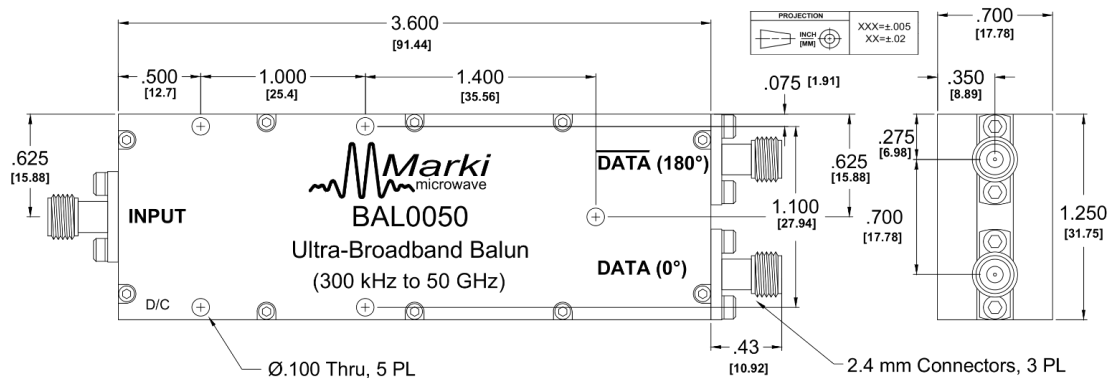

Broadband Isolation Balun (300KHz to 50GHz)

BAL-0050

Page 2

Block Diagram

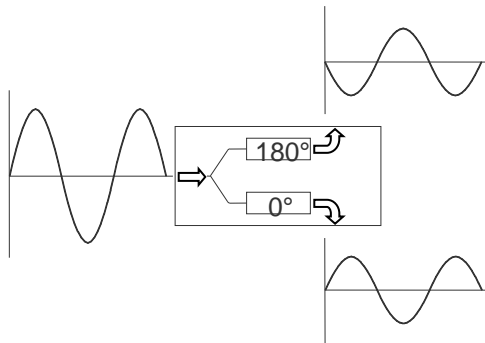

Single ended to differential

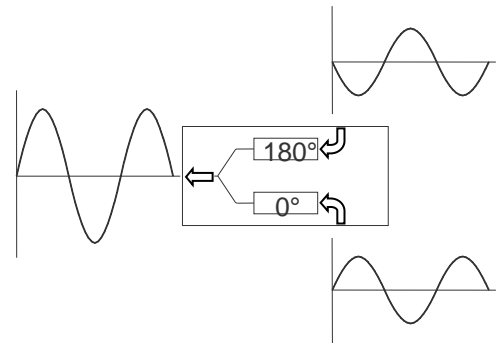

Differential to single ended

Typical Performance

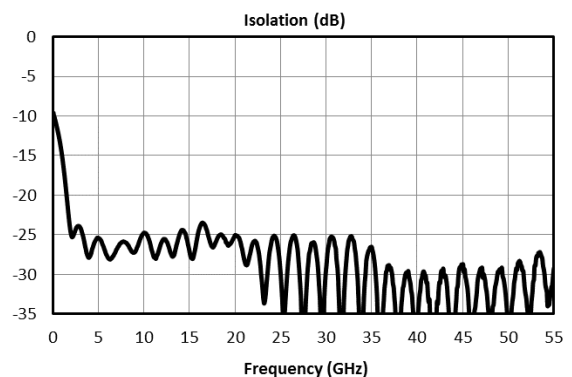
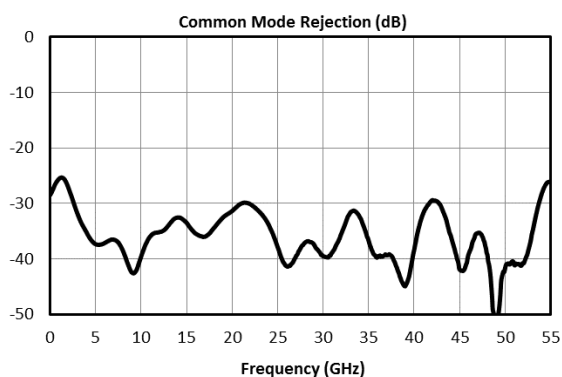
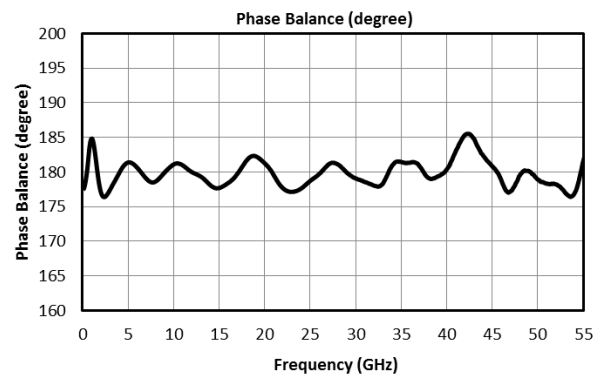
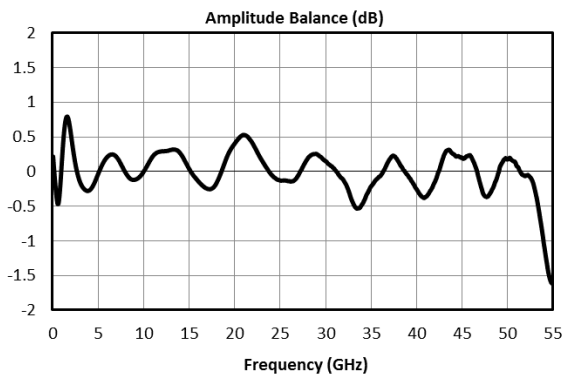
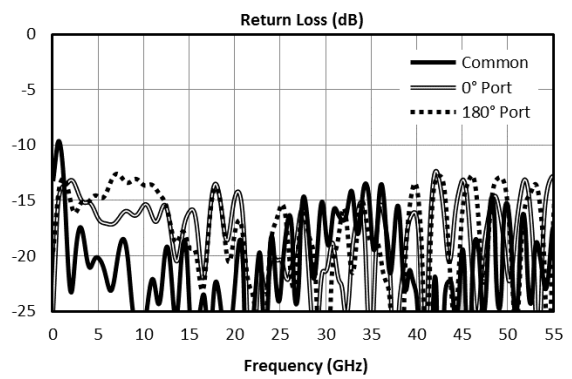
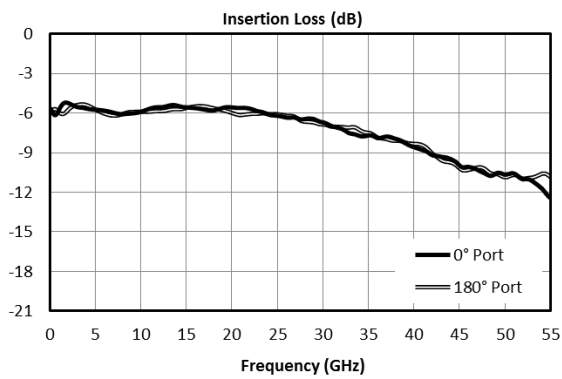

Broadband Isolation Balun (300KHz to 50GHz)

BAL-0050

Page 3

Typical Performance

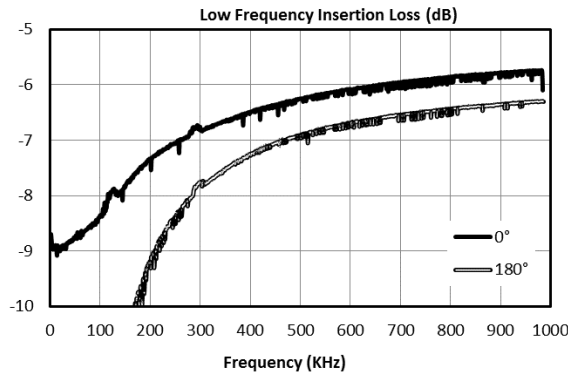
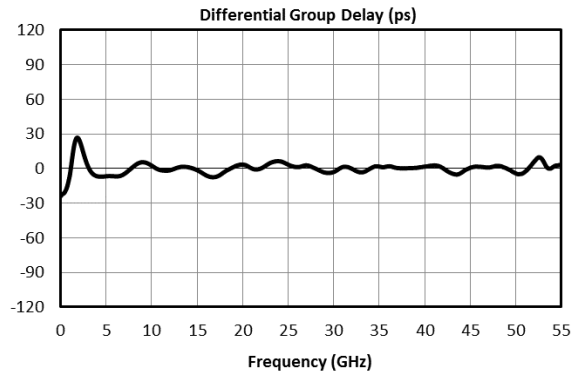
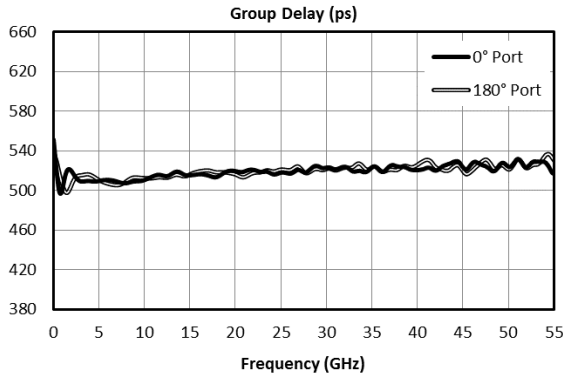

This space is left blank intentionally

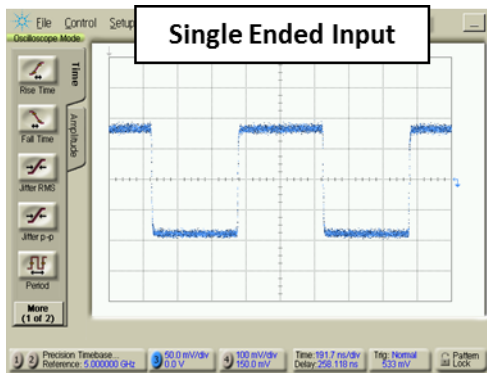

Low frequency 1MHz square wave input

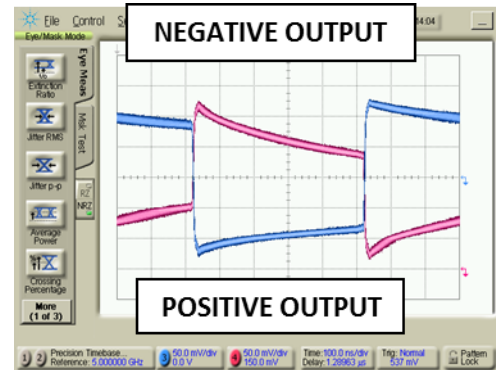

Low frequency oscilloscope measurement of a 1MHz square wave input. Blue is 0° port output, pink is 180° port output. Note the amplitude divergence due to slight high pass roll off near DC.

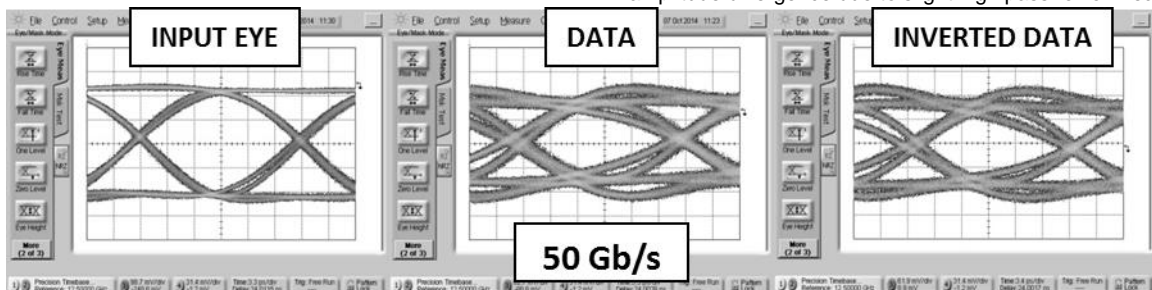

Oscilloscope measurements of the BAL-0050 with a 50 Gb/s PRBS pattern in single ended-to-differential mode. Eye diagrams are taken with a 231-1 PRBS input demonstrating minimal eye distortion/closure afforded by the extremely low frequency operation of the balun (<300 kHz).

Broadband Isolation Balun (300KHz to 50GHz)

BAL-0050

Page 4

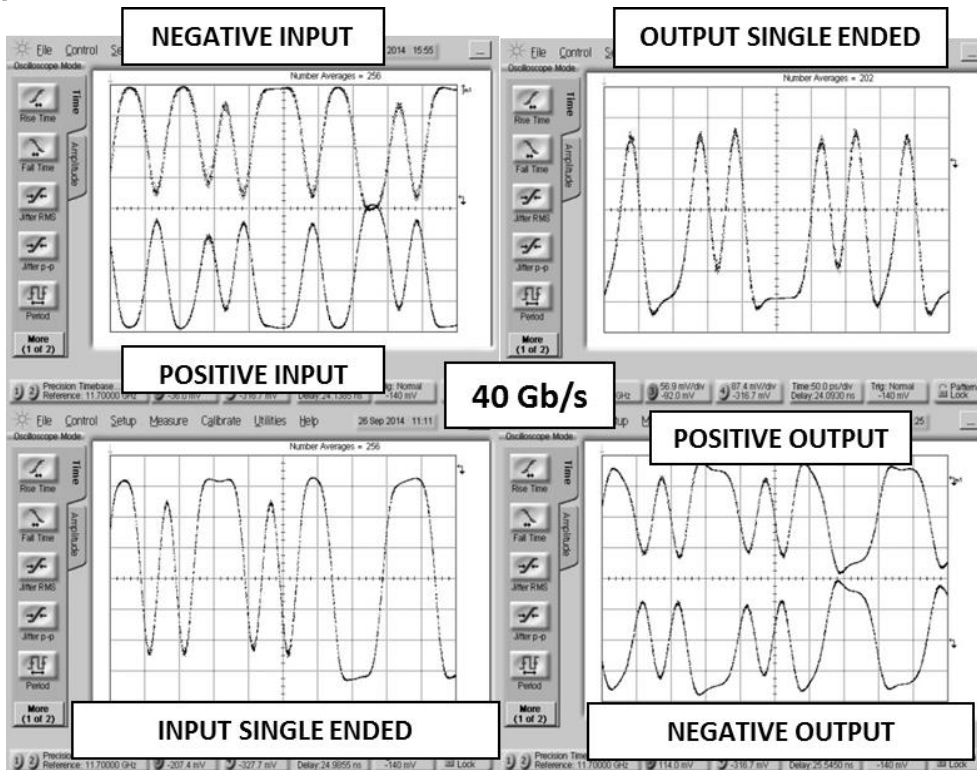

Oscilloscope measurements of the BAL-0050 with a 40 Gb/s PRBS pattern. Bit pattern is measured with a 2^7-1 PRBS input demonstrating extremely good pulse fidelity for both differential-to-single ended and single ended to differential mode conversions. Apparent baseline wander in differential-to-single ended is due to low pass filtering by test cables.

Broadband Isolation Balun (300KHz to 50GHz)

BAL-0050

Page 5

Mixed Mode Scattering Parameters

Mixed mode scattering parameters are used to characterize differential circuits. For baluns, this means that the 0° and 180° ports become a single 100Ω differential port and the common port remains the same 50Ω common port. The two-port s-parameters of the balun are then characterized based on differential (d), common mode (c), or single-ended (s) signals. For example: S12ds is the differential output response given a single ended input.

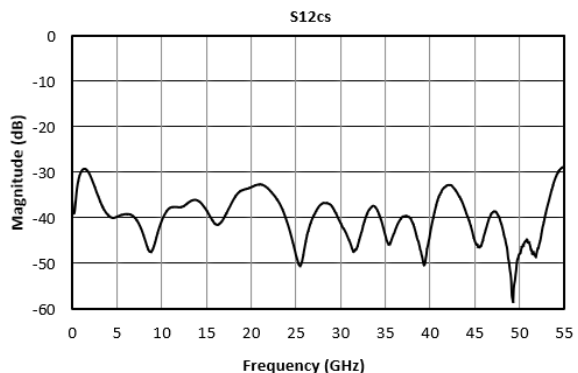
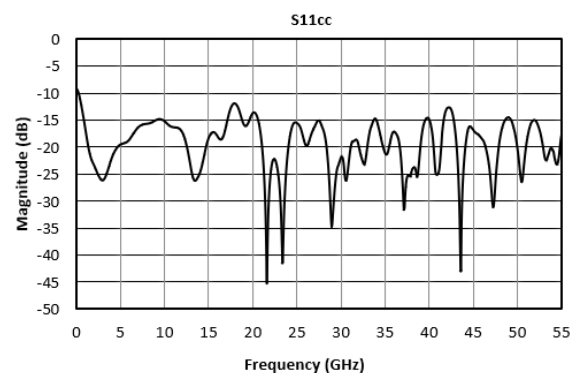
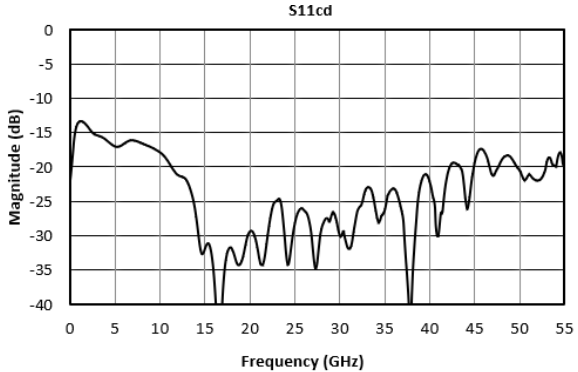
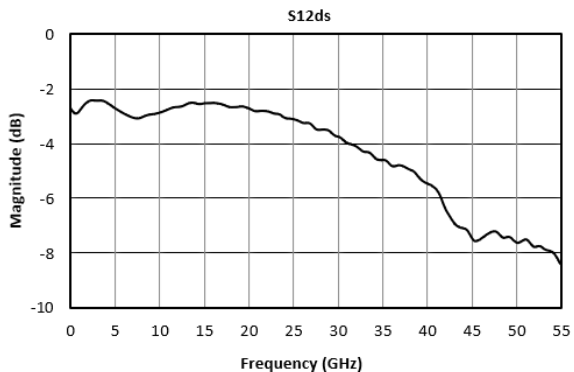
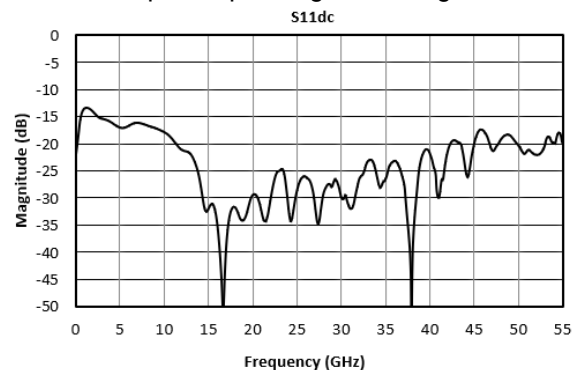
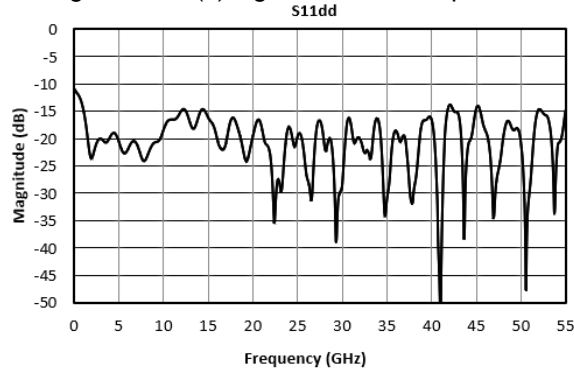

Broadband Isolation Balun (300KHz to 50GHz)

BAL-0050

Page 6

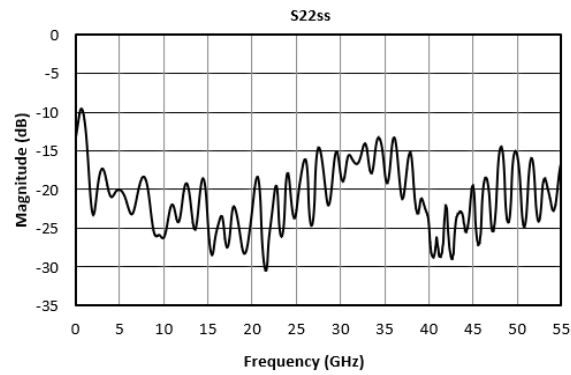
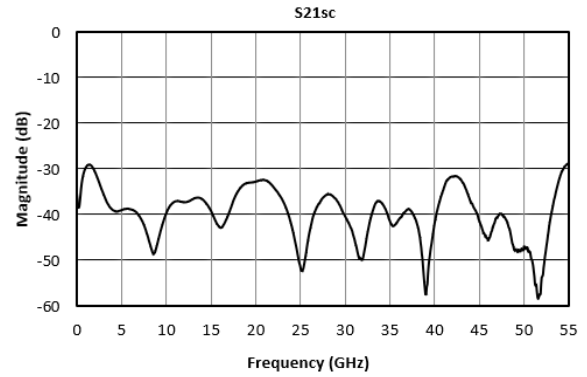
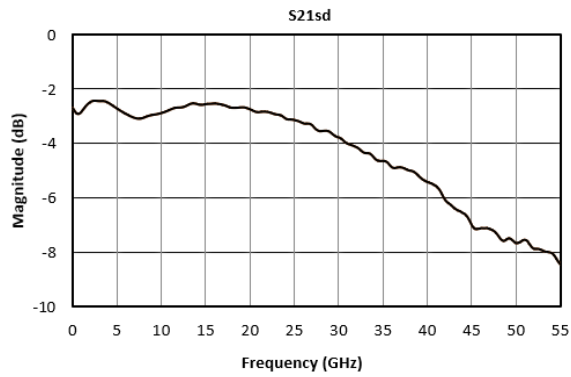

Broadband Isolation Balun (300KHz to 50GHz)

BAL-0050

Page 7

DC Interface

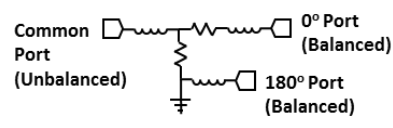
Port	Description	DC Interface Schematic
Common (Unbalanced Port)	The common port is DC connected to the 0° port through a resistor and to ground through a resistor.	
0° Port (Balanced)	The 0° port is DC connected to the common port through a resistor and to ground through a resistor.	
180° Port (Balanced)	The 180° port is DC shorted to ground.	

Revision History

Revision code	Revision Date	Comment
-	2014	Datasheet initial Release
A	2016	Typical Performance Plots Updated
B	October 2019	Mixed Mode Scattering Parameters added
C	November 2019	RoHS Compliant assembly
D	July 2020	Specs Table Update

DATA SHEET NOTES:

- Specifications are subject to change without notice. Contact Marki Microwave for the most recent specifications and data sheets.
- Catalog mixer circuits are continually improved. Configuration control requires custom mixer model numbers and specifications.

Note: Exposure to maximum rating conditions for extended periods may reduce device reliability. There is no damage to device with only one parameter set at the limit and all other parameters set at or below their nominal value. Exceeding any of the limits listed here may result in permanent damage to the device.

Marki Microwave reserves the right to make changes to the product(s) or information contained herein without notice. Marki Microwave makes no warranty, representation or guarantee regarding the suitability of its products for any particular purpose, nor does Marki Microwave assume any liability whatsoever arising out of the use of or application of any product.