

LEAD-FREE / RoHS-COMPLIANT

SURFACE-MOUNT BROADBAND BALUN

BAL-0006SMG

Features

- 500 kHz to 6 GHz 1:2 Balun (Balanced to Unbalanced Transformer)
- Transforms 50 Ω Input to 100 Ω Differential (50 Ohm Single) Output
- Tuned for Optimal Phase/Amplitude Balance
- Applications: Analog to Digital Converters, Balanced Receivers, Baseband Digital Modulation, Signal Integrity
- [BAL-0006SMG.s3p](#)



Electrical Specifications - Specifications guaranteed from -55 to +100°C, measured in a 50 Ω system.

Parameter	Frequency Range	Min	Typ	Max	
Insertion Loss as a mode converter (dB)	500 kHz to 6 GHz		4	5.5	
Nominal Phase Shift (Degrees)			180		
Amplitude Balance (dB)			0.4	1.2	
Phase Balance (Degrees)			3	10	
Common Mode Rejection (dB)			20	30	
Isolation (dB)				8	
VSWR				1.5	
Total Input Power (W)					1
Risetime /Falltime (ps) ¹				17	

¹Specified as 90%/10%. Calculated from $\tau_{\text{balun}}^2 = (\tau_{\text{out}}^2 - \tau_{\text{in}}^2)$

Model Number	Description
BAL-0006SMG	500 kHz to 6 GHz Balun, Surface Mount, LEAD-FREE/RoHS COMPLIANT
EVAL-BAL-0006	Connectorized Evaluation Fixture, LEAD-FREE/RoHS COMPLIANT

SURFACE-MOUNT BROADBAND BALUN

BAL-0006SMG

Page 2

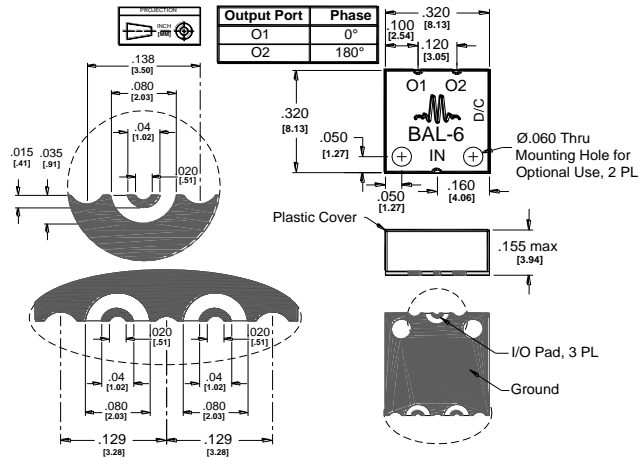

Substrate material is 8-mil thick Rogers 4003, 1 Oz Electrodeposited Cu. I/O Pads & Ground Plane Finish is Gold Flash, 5 to 10 μ-inches, over Electroplated Nickel, 100-200 μ-inches, over Cu. See [BALSMG-PCB](#) for suggested PCB layout.

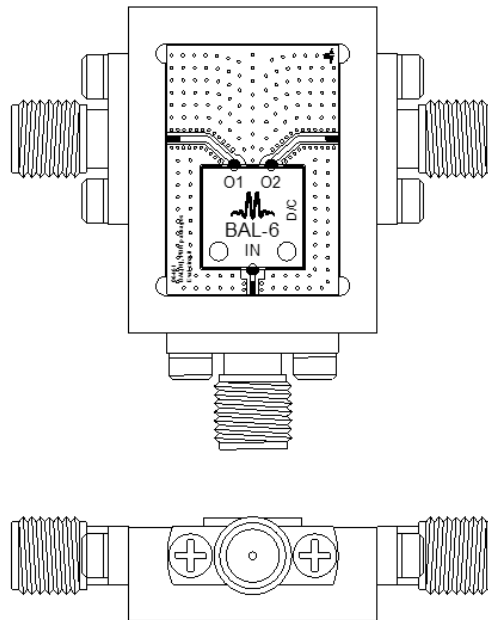

Evaluation Board outline

SURFACE-MOUNT BROADBAND BALUN

BAL-0006SMG

Page 3

Block Diagram

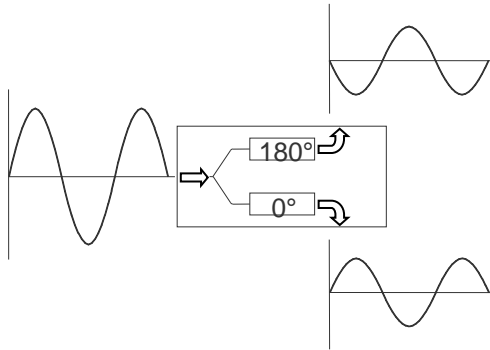

Single ended to differential

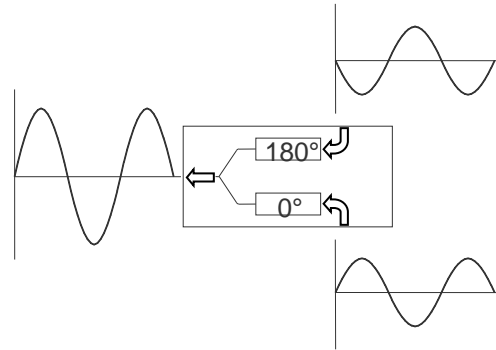

Differential to single ended

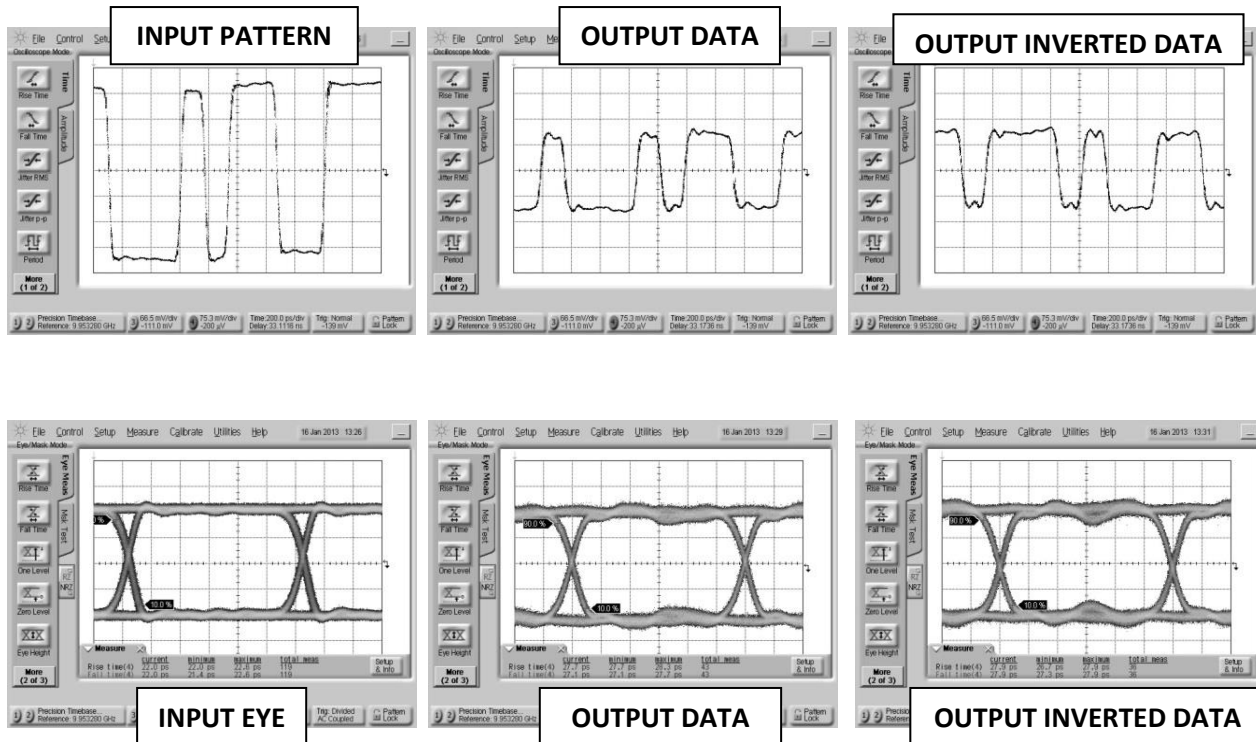

Fig. 1. Oscilloscope measurements of the BAL-0006SMG with a 6 Gb/s PRBS pattern. Bit pattern is measured with a 2^7-1 PRBS input demonstrating extremely good pulse fidelity for both inverted and non-inverted output. Eye diagrams are taken with a $2^{31}-1$ PRBS input demonstrating minimal eye distortion/closure afforded by the extremely low frequency operation of the balun (<500 kHz).

Mixed Mode Scattering Parameters

Mixed mode scattering parameters are used to characterize differential circuits. For baluns, this means that the 0° and 180° ports become a single 100Ω differential port and the common port remains the same 50Ω common port. The two-port s-parameters of the balun are then characterized based on differential (d), common mode (c), or single-ended (s) signals. For example: Sds12 is the differential output response given a single ended input.

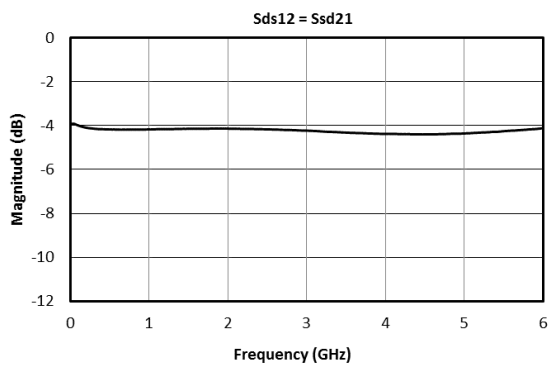

Fig. 2. Insertion loss as a mode converter

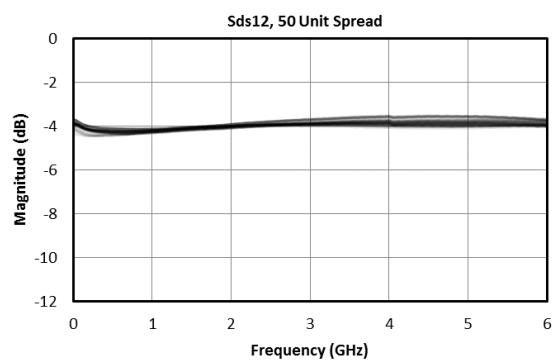

Fig. 3. Insertion loss as a mode converter across 50 units

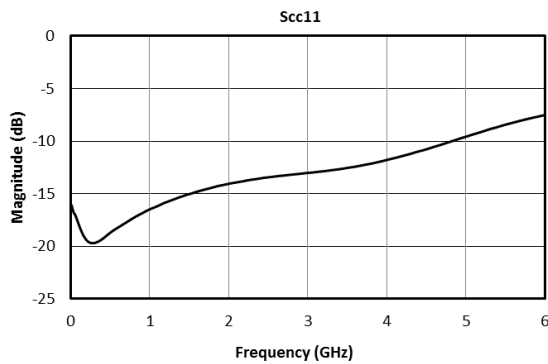

Fig. 4. Return loss of a common mode signal

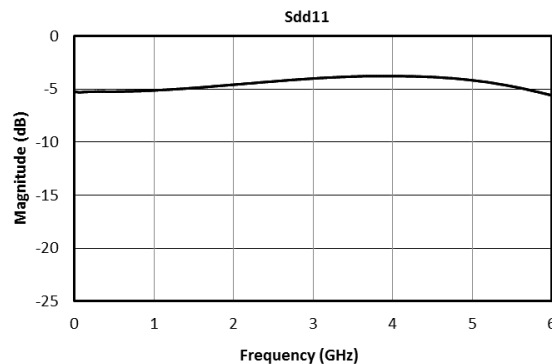

Fig. 5. Return loss of a differential signal

SURFACE-MOUNT BROADBAND BALUN

BAL-0006SMG

Page 5

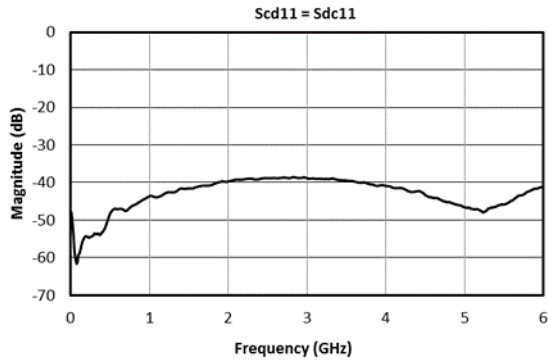

Fig. 6. Reflection converted between differential and common modes

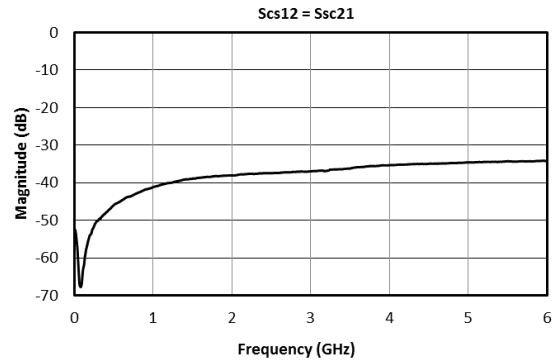

Fig. 7. Insertion loss of a common mode signal

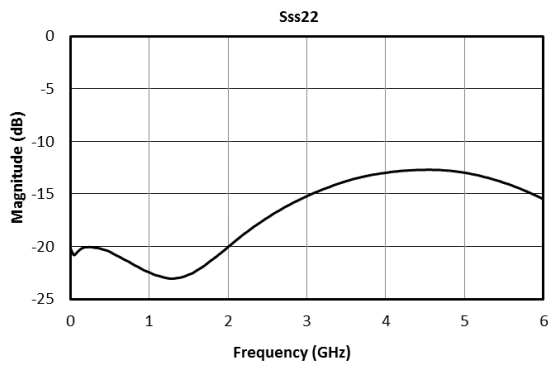

Fig. 8. Unbalanced port return loss

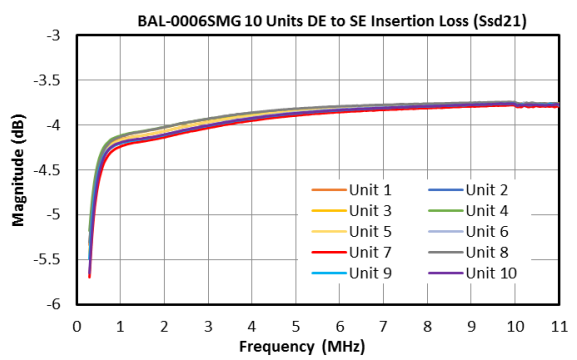

Fig. 9. Low frequency Insertion loss as a mode converter across 10 units

Typical Performance Scattering Parameters

Three port scattering parameters measured as three single-ended 50Ω ports showing relationship between any two ports. For example: S21 and S31, often referred to as insertion loss of a balun, is the output response on ports 2 and 3 with an input stimulus on port 1.

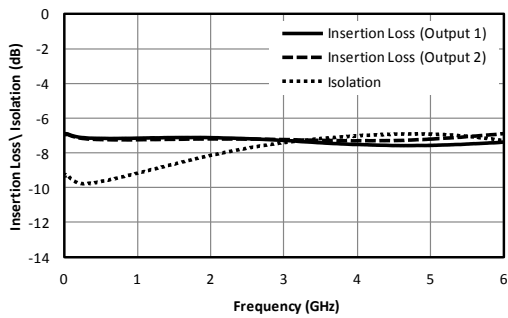

Fig. 10. Common to output port insertion loss and output to output port Isolation.

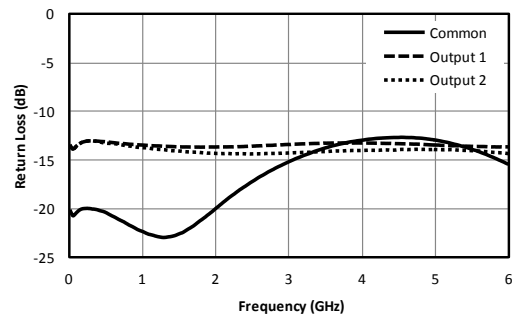

Fig. 11. Return loss for common port and output ports.

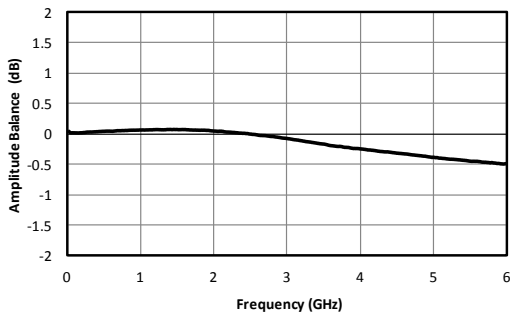

Fig. 12. Amplitude balance between output ports.

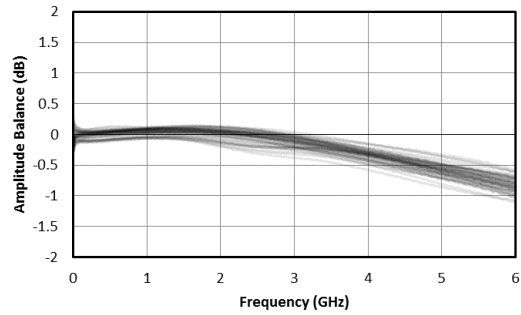

Fig. 13. Amplitude balance, 50 unit spread.

SURFACE-MOUNT BROADBAND BALUN

BAL-0006SMG

Page 7

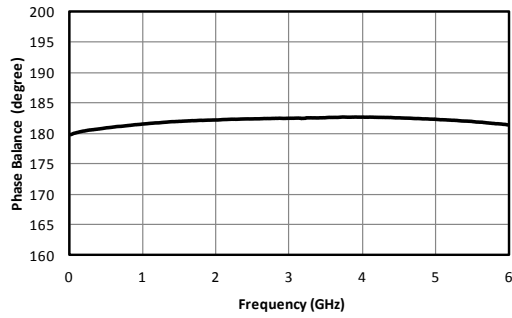

Fig. 14. Phase balance between output ports

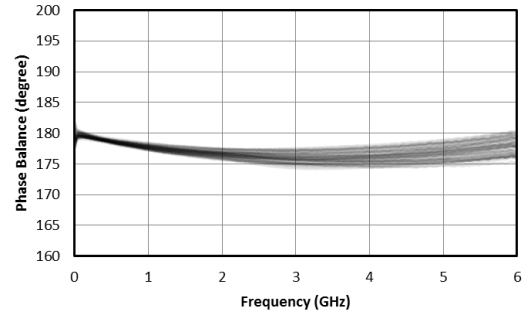

Fig. 15. Phase balance, 50 unit spread

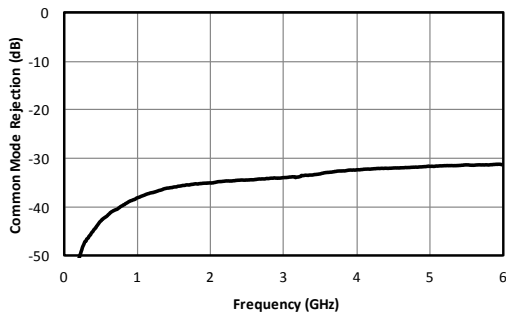

Fig. 16. Common mode rejection.

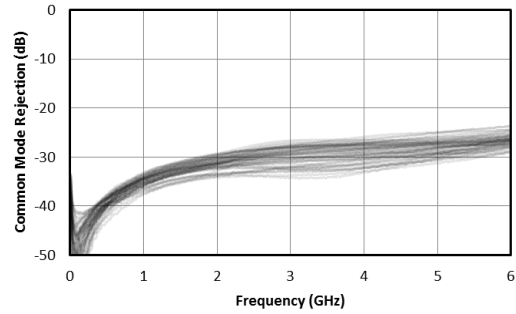

Fig. 17. Common mode rejection, 50 unit spread

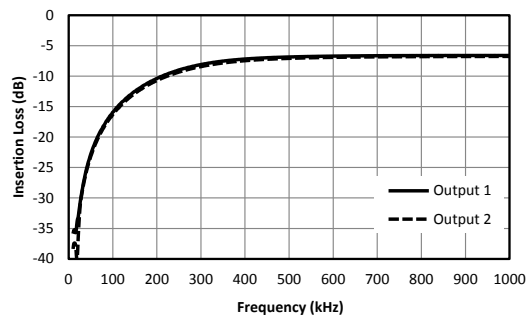

Fig. 18. Low Frequency Response

SURFACE-MOUNT BROADBAND BALUN

BAL-0006SMG

Page 8

DC Interface

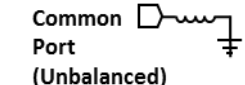
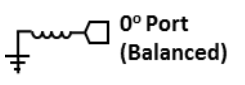
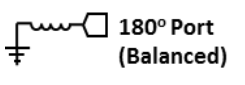
Port	Description	DC Interface Schematic
Common Port / In (Unbalanced)	The common port is DC short to ground.	 <p>Common Port (Unbalanced)</p>
Out 1 / 0° Port (Balanced)	The 0° port is DC short to ground.	 <p>0° Port (Balanced)</p>
Out 2 / 180° Port (Balanced)	The 180° port is DC short to ground.	 <p>180° Port (Balanced)</p>

Absolute Maximum Ratings	
Parameter	Maximum Rating
DC Current	TBD
RF Power Handling	33 dBm
Operating Temperature	-55°C to +100°C
Storage Temperature	-65°C to +125°C



SURFACE-MOUNT BROADBAND BALUN

BAL-0006SMG

Page 9

DATASHEET NOTES:

1. Specified as 90%/10%. Calculated from $\tau_{\text{balun}}^2 = (\tau_{\text{out}}^2 - \tau_{\text{in}}^2)$ with a 6 Gb/s input pattern.
2. Sdd22: differential return loss of the differential port driven with a differential signal
Sdc22: differential return loss of the differential port driven with a common signal
Sds21: insertion loss from a single ended input to a differential output
Scc22: common mode return loss of the differential port driven with a common signal
Scd22: common mode return loss of the differential port driven with a differential signal
Scs21: insertion loss from a single ended input to a common output
Sss11: single ended return loss
Ssd12: insertion loss from a differential signal to single ended output
Ssc12: insertion loss from a common signal to single ended output

Revision History

Revision code	Revision Date	Comment
-	February 2013	Datasheet initial Release
A	March 2019	Evaluation board outline added
B	October 2019	Mixed Mode Scattering Parameters added
C	April 2020	Unit Spread Graphs Added
D	July 2020	Update Specs table & low frequency Ssd21 plot added
E	October 2020	Update Specs table

Marki Microwave reserves the right to make changes to the product(s) or information contained herein without notice. Marki Microwave makes no warranty, representation or guarantee regarding the suitability of its products for any particular purpose, nor does Marki Microwave assume any liability whatsoever arising out of the use of or application of any product.