

## LEAD-FREE / RoHS-COMPLIANT

### SURFACE-MOUNT BROADBAND BALUN

### BAL-0006SMG

#### Features

- 500 kHz to 6 GHz 1:2 Balun (Balanced to Unbalanced Transformer)
- Transforms 50  $\Omega$  Input to 100  $\Omega$  Differential (50 Ohm Single) Output
- Tuned for Optimal Phase/Amplitude Balance
- Applications: Analog to Digital Converters, Balanced Receivers, Baseband Digital Modulation, Signal Integrity
- [BAL-0006SMG.s3p](#)

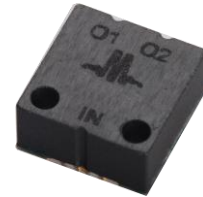

**Electrical Specifications** - Specifications guaranteed from -55 to +100°C, measured in a 50 $\Omega$  system.

Parameter	Frequency Range	Min	Typ	Max	
Nominal Insertion Loss (dB)	500 kHz to 6 GHz		6		
Nominal Phase Shift (Degrees)			180		
Amplitude Balance (dB)			$\pm 0.4$	$\pm 1.2$	
Phase Balance (Degrees)			$\pm 3$	$\pm 10$	
Common Mode Rejection (dB)		20	30		
Excess Insertion Loss (dB) <sup>1</sup>			1	2.5	
Isolation (dB)			8		
VSWR			1.5		
Total Input Power (W)					1
Risetime /Falltime (ps) <sup>2</sup>				17	

<sup>1</sup>Excess Insertion Loss = (Common Port to Output Port Insertion Loss) – 6 dB.

<sup>2</sup>Specified as 90%/10%. Calculated from  $\tau_{\text{balun}}^2 = (\tau_{\text{out}}^2 - \tau_{\text{in}}^2)$

Model Number	Description
BAL-0006SMG	500 kHz to 6 GHz Balun, Surface Mount, <b>LEAD-FREE/RoHS COMPLIANT</b>

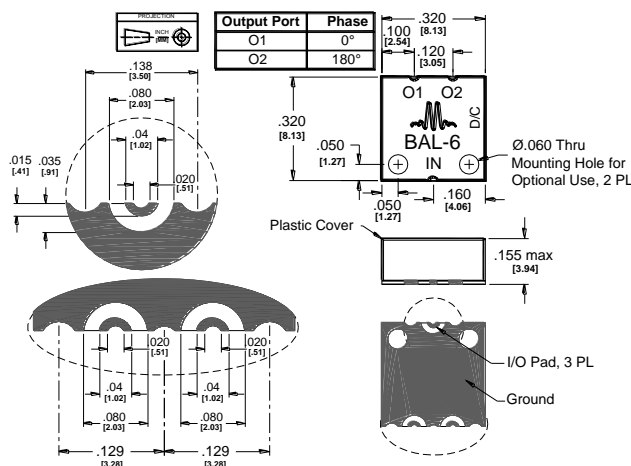

Substrate material is 8-mil thick Rogers 4003, 1 Oz Electrodeposited Cu. I/O Pads & Ground Plane Finish is Gold Flash, 5 to 10  $\mu$ -inches, over Electroplated Nickel, 100-200  $\mu$ -inches, over Cu. See [BALSMG-PCB](#) for suggested PCB layout.

# SURFACE-MOUNT BROADBAND BALUN

# BAL-0006SMG

Page 2

## Block Diagram

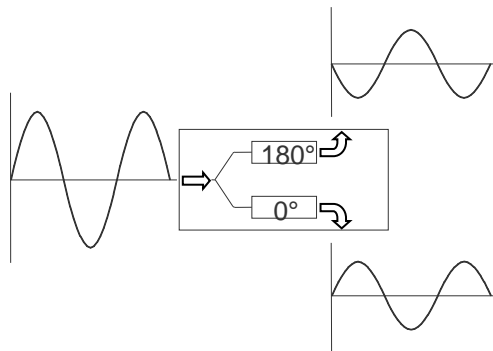

Single ended to differential

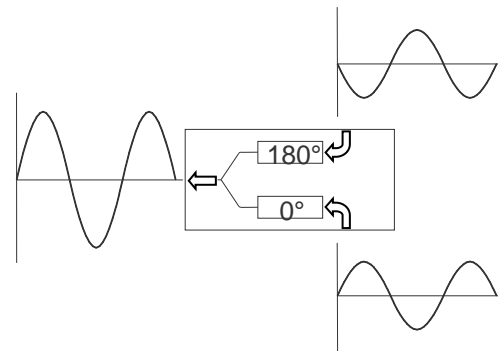

Differential to single ended

## Typical Performance

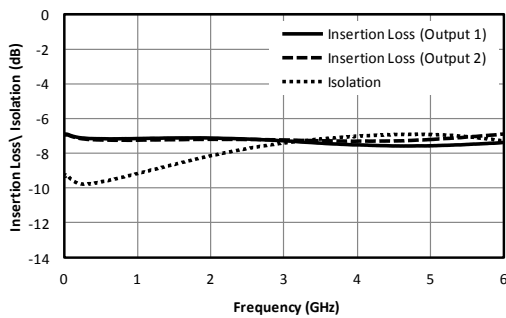

Fig. 1. Common to output port insertion loss and output to output port Isolation.

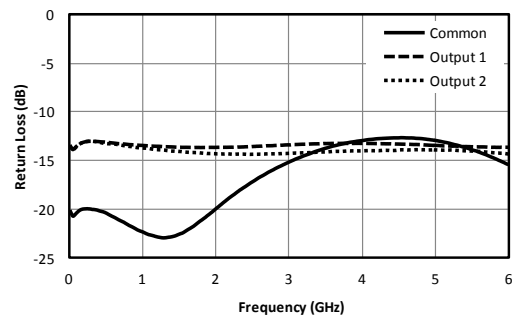

Fig. 2. Return loss for common port and output ports.

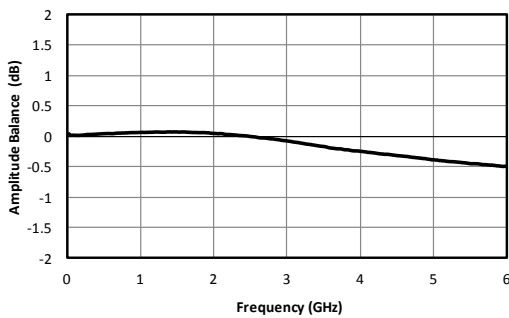

Fig. 3. Amplitude balance between output ports.

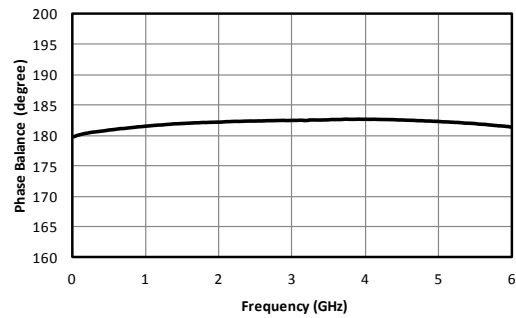

Fig. 4. Phase balance between output ports.

# SURFACE-MOUNT BROADBAND BALUN

# BAL-0006SMG

Page 3

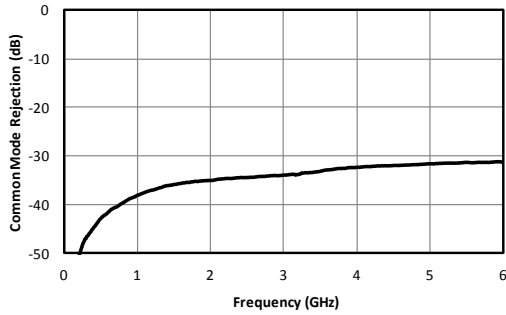

Fig. 5. Common mode rejection.

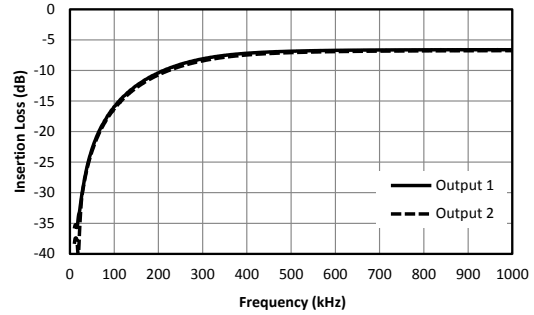

Fig. 6. Low Frequency Response

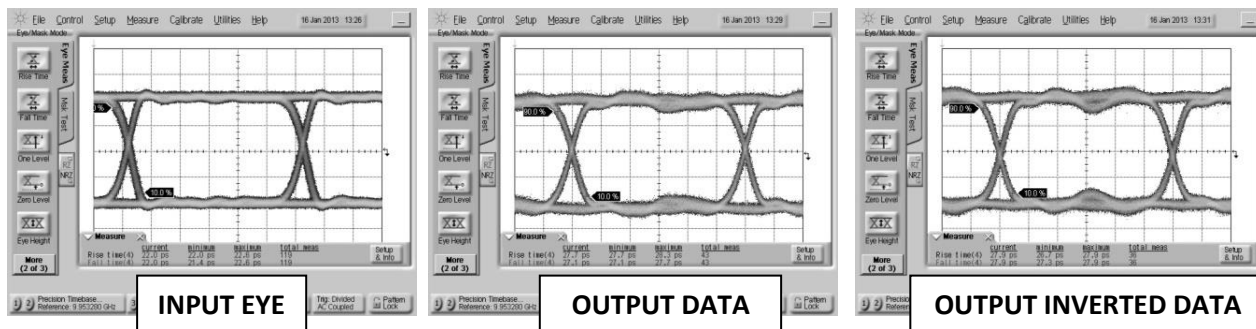
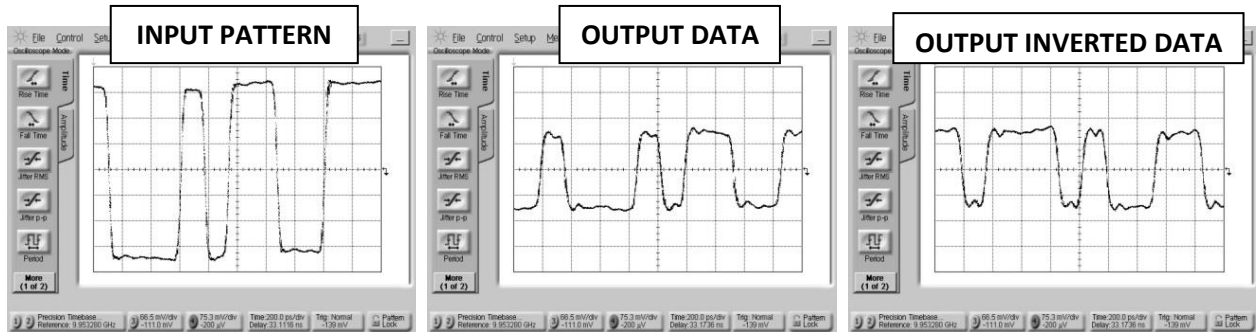

Fig. 6. Oscilloscope measurements of the BAL-0006SMG with a 6 Gb/s PRBS pattern. Bit pattern is measured with a  $2^7-1$  PRBS input demonstrating extremely good pulse fidelity for both inverted and non-inverted output. Eye diagrams are taken with a  $2^{31}-1$  PRBS input demonstrating minimal eye distortion/closure afforded by the extremely low frequency operation of the balun (<500 kHz).



## SURFACE-MOUNT BROADBAND BALUN

**BAL-0006SMG**

Page 4

### DC Interface

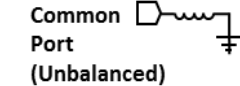
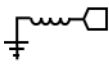
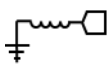
Port	Description	DC Interface Schematic
Common Port / In (Unbalanced)	The common port is DC short to ground.	 Common Port (Unbalanced)
Out 1 / 0° Port (Balanced)	The 0° port is DC short to ground.	 0° Port (Balanced)
Out 2 / 180° Port (Balanced)	The 180° port is DC short to ground.	 180° Port (Balanced)

Absolute Maximum Ratings	
Parameter	Maximum Rating
DC Current	TBD
RF Power Handling	33 dBm
Operating Temperature	-55°C to +100°C
Storage Temperature	-65°C to +125°C

Marki Microwave reserves the right to make changes to the product(s) or information contained herein without notice. Marki Microwave makes no warranty, representation or guarantee regarding the suitability of its products for any particular purpose, nor does Marki Microwave assume any liability whatsoever arising out of the use of or application of any product.