

21-56 GHz Amplified 4F Multiplier

AQA-2156

1. Device Overview

1.1 General Description

The AQA-2156 is an amplified frequency multiplier that quadruples the 5.25 – 14 GHz input frequency, producing an amplified 21 - 56 GHz quadrupled output frequency. This multiplier is designed to provide +20 dBm 4F output power with +0 dBm input power, and offers superior harmonic suppressions. It consists of an input buffer APM-6848 amplifier, MMD-1030H doubler, 2nd APM-6848 buffer amplifier, MMD-1648L doubler, and an output AMM-6702 amplifier. It is capable of providing sufficient LO drive for Marki S-, H-, and L- diode mixers.



1.2 Features

- High fundamental rejection
- Millimeter wave output frequencies
- +20 dBm 4F output Power
- +4V/-5V Bias

1.3 Applications

- High frequency synthesis
- LO drive for S-diode mixers
- LO signal chain

1.4 Electrical Summary

Parameter	Typical	Unit
Input Frequency Range	5.25 - 14	GHz
Output Frequency Range	21 - 56	GHz
Input Power	-2 to +6	dBm
4F Output Power	+20	dBm
1F Harmonic suppression	49	dBc
2F Harmonic Suppression	37	dBc
3F Harmonic Suppression	28	dBc
5F Harmonic suppression	34	dBc

1.5 Functional Block Diagram

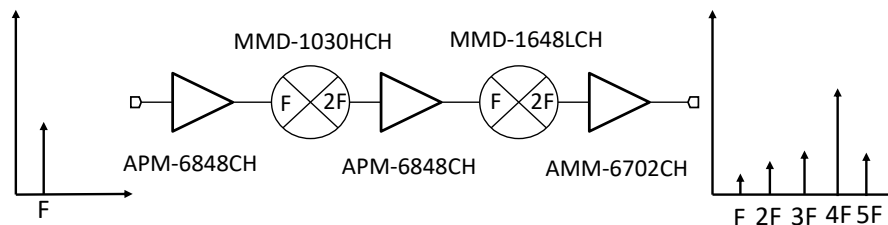

1.6 Part Ordering Options¹

Part Number	Description	Green Status	Product Lifecycle	Export Classification
AQA-2156	Connectorized Module	RoHS	Active	EAR99

¹ Refer to our [website](#) for a list of definitions for terminology presented in this table.

Table of Contents

1. Device Overview	1	2.2 Port Functions	3
1.1 General Description	1	3. Specifications	4
1.2 Features	1	3.1 Absolute Maximum Ratings.....	4
1.3 Applications	1	3.2 Sequencing Requirements	4
1.4 Electrical Summary.....	1	3.3 Heat Sinking	4
1.5 Functional Block Diagram	1	3.4 Electrical Specifications	5
1.6 Part Ordering Options.....	1	3.5 Typical Performance Plots	6
2. Port Configurations and Functions	3	4. Mechanical Data	8
2.1 Port Diagram.....	3	4.1 Outline Drawing	8

Revision History

Revision Code	Revision Date	Comment
-	April 2020	Initial Release Datasheet
A	July 2020	Updated Min Output Power and Suppression Specs
B	August 2020	Inclusion of internal chipset
C	October 2020	Adjusted Build to Reduce Power Dissipation, Updated Bias Condition, Updated Absolute Maximum Specifications, Updated Performance Plots

2. Port Configurations and Functions

2.1 Port Diagram

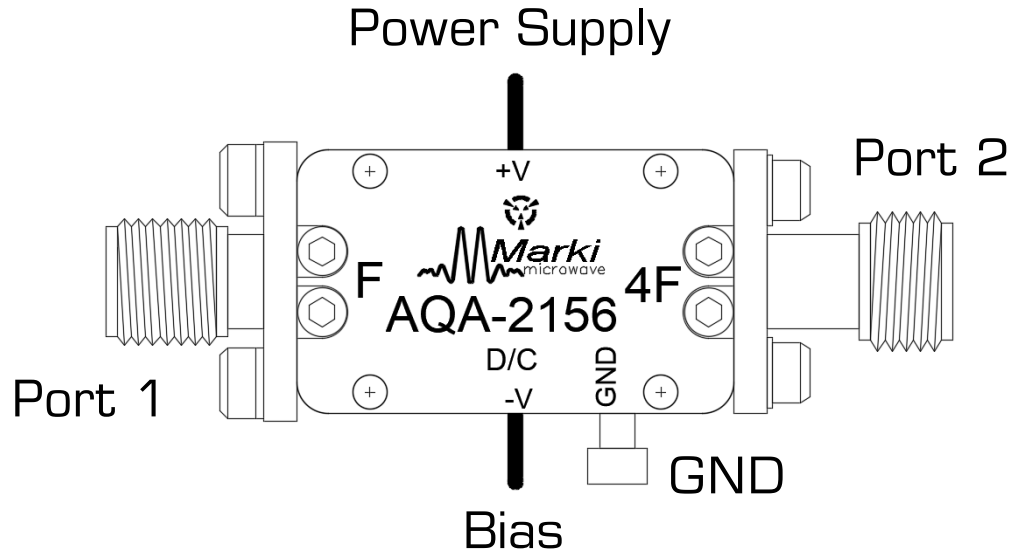

2.2 Port Functions

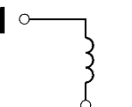
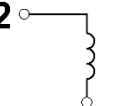
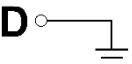
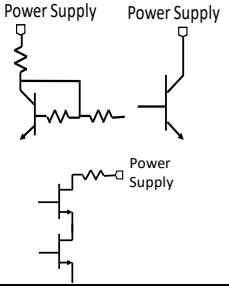
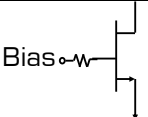
Port	Function	Description	Equivalent Circuit
Port 1	Input	This pin is for the RF input. It is internally DC-blocked and is matched to 50 ohms from 5.25-14 GHz	P1 
Port 2	Output	This pin is for the RF output. It is internally DC-blocked matched to 50 ohms from 21-56 GHz	P2 
GND	Ground	Ground path is provided through the metal housing and outer ground lug.	GND 
Power Supply	Positive bias	Positive bias port must be connected to a +3V to +4.5V power supply.	
Bias	Negative bias	Gate control for the amplifier must be connected to a -5.0 to -6.0 Volt power supply.	

3. Specifications

3.1 Absolute Maximum Ratings

The Absolute Maximum Ratings indicate limits beyond which damage may occur to the device. If these limits are exceeded, the device may be inoperable or have a reduced lifetime.

Absolute Maximum Ratings	
Parameter	Maximum Rating
Positive Bias Voltage	4.5 V
Positive Bias Current	600 mA
Negative Bias Voltage	-10 V
Negative Bias Current	3 mA
RF Input Power	+10 dBm
ESD (Human Body Model)	Class 1A
Operating Temperature	-40°C to +50°C
Storage Temperature	-65°C to +150°C

3.2 Sequencing Requirements

Turn-on Procedure:

- 1) Apply -5V to Bias port
- 2) Apply +4V to Power Supply port

Turn-off Procedure:

- 1) Turn off Power Supply port
- 2) Turn off Bias port

3.3 Heat Sinking

The AQA-2156 module requires sufficient heatsinking (as providing by mounting onto a metal chassis) and/or a fan providing airflow onto the unit. Failure to provide sufficient heatsinking/cooling can result in operating temperatures exceeding the absolute maximum of +50°C, and will likely cause damage to the unit. The cooling provided by a fan significantly reduces the package temperature and is highly recommended when operating the AQA-2156.

3.4 Electrical Specifications

The electrical specifications apply at $T_A=+25^{\circ}\text{C}$ in a 50Ω system.

Parameter	Test Conditions	Min	Typical	Max	Units
Input (Port 1) Frequency Range		5.25		14	GHz
Output (Port 2) Frequency Range		21		56	
Input Power ²		-	+2	-	dBm
4F Output Power	Input = 5.25 – 14 GHz Output = 21 - 56 GHz	12	20		dBm
Suppression ³	1F Input = 5.25 – 14 GHz Output = 5.25 – 14 GHz		49		dBc
	2F Input = 5.25 – 14 GHz Output = 10.5 - 28 GHz		37		
	3F Input = 5.25 – 14 GHz Output = 15.75 - 42 GHz		28		
	5F Input = 5.25 – 13.4 GHz Output = 26.25 - 67 GHz		34		
Bias Requirements ⁴ Power Supply: +4.0 Volts DC Bias: -5.0 Volts DC			300 0.001		mA

² Optimal suppression levels at 0 - +2 dBm input power.

³ Suppression is defined as the harmonic power relative to the 4F quadrupled output power.

⁴ Current consumption taken under NO RF input power. Current draw will increase with increased input power. Optimal Performance is at approximately +4.0V / -5.0V.

3.5 Typical Performance Plots

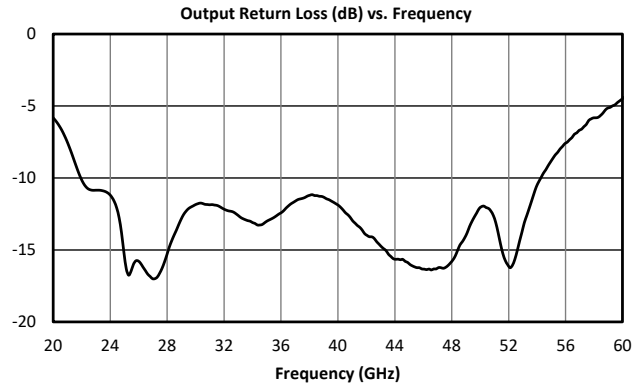
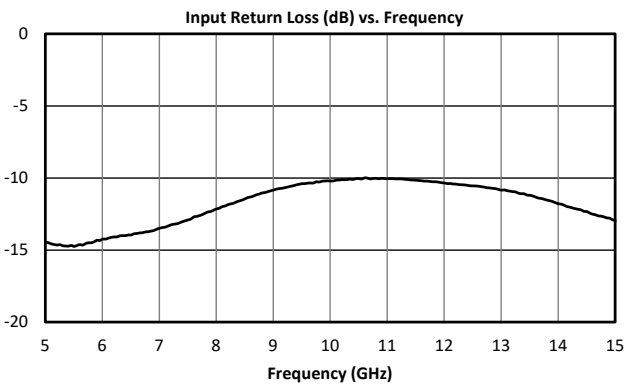
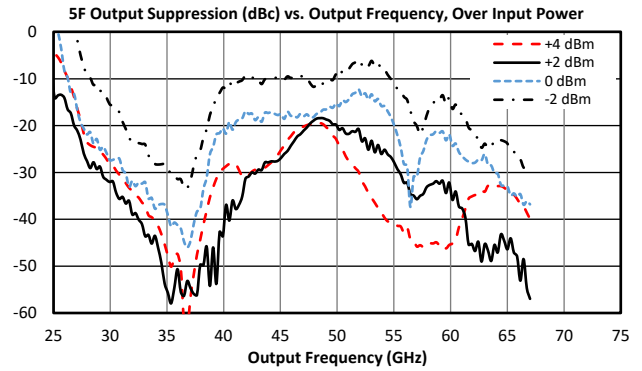
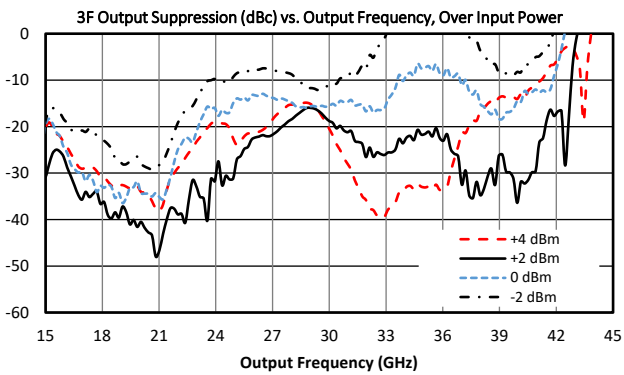
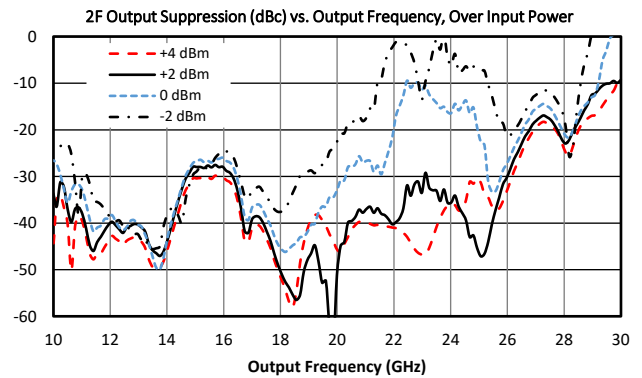
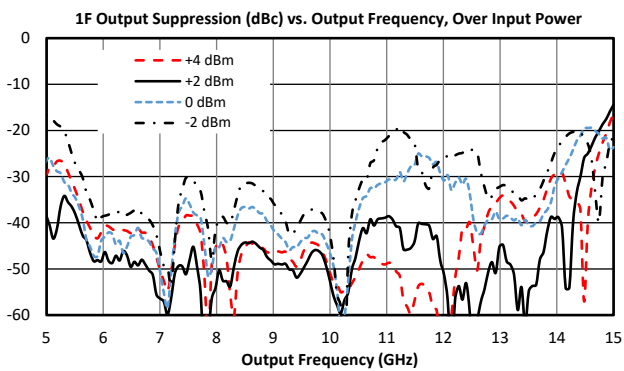
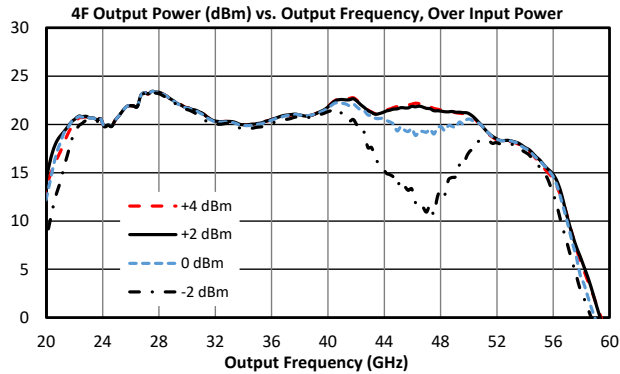

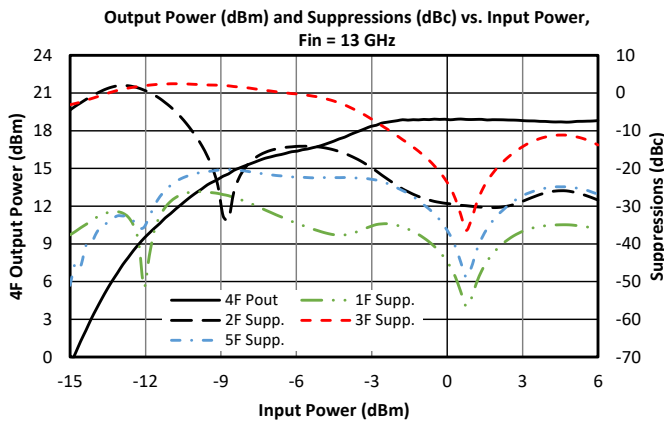
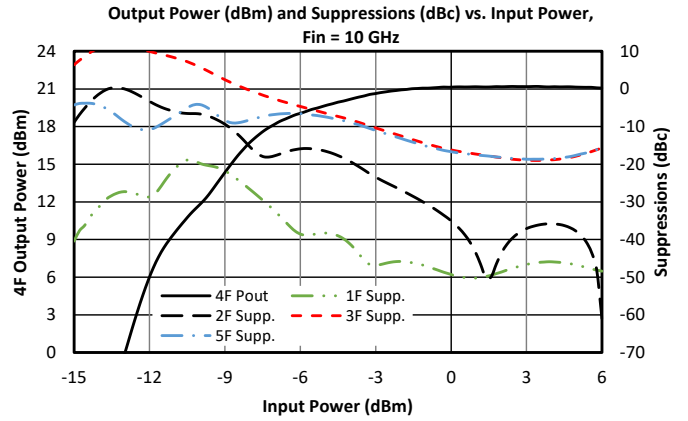
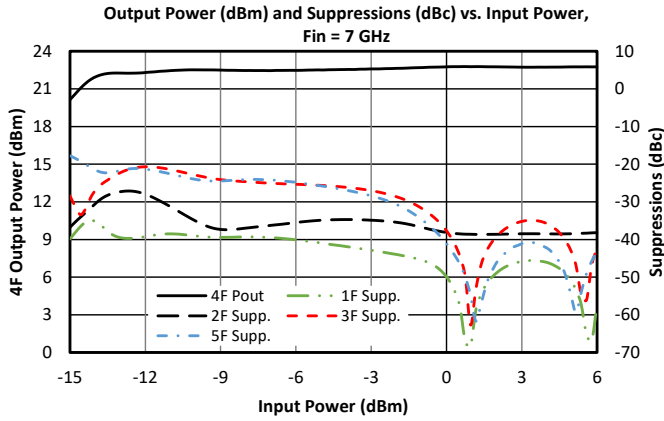

4. Mechanical Data

4.1 Outline Drawing

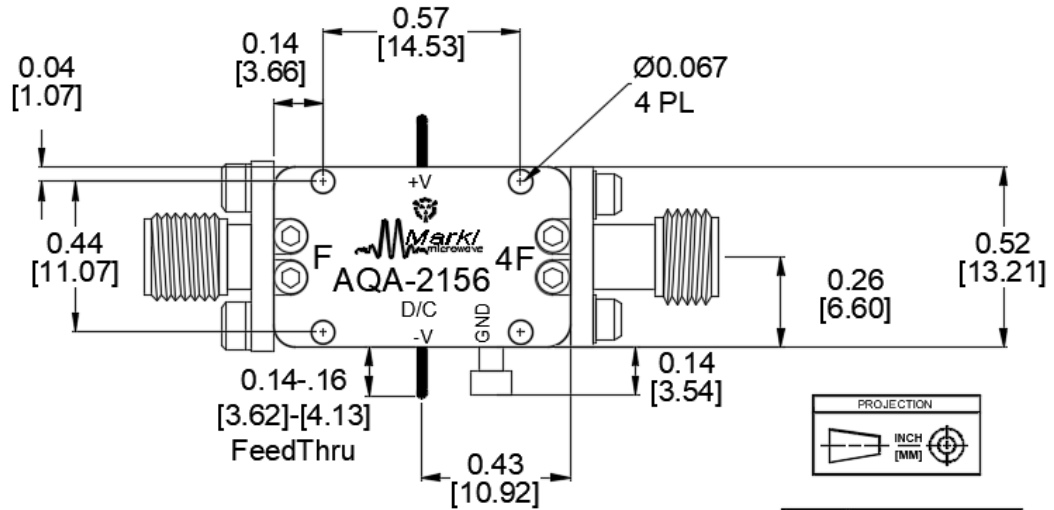

*Note: All measurements are typical

