

21-56 GHz Amplified 4F Multiplier

AQA-2156

1. Device Overview

1.1 General Description

The AQA-2156 is an amplified frequency multiplier that quadruples the 5.25 – 14 GHz input frequency, producing an amplified 21 - 56 GHz quadrupled output frequency. This multiplier provides greater than +20 dBm 4F output power with +0 dBm input power, and offers superior harmonic suppressions. It consists of an input buffer APM-6848 amplifier, MMD-1030H doubler, 2nd APM-6848 buffer amplifier, MMD-1648L doubler, and an output AMM-6702 amplifier. It is capable of providing sufficient LO drive for Marki H- and S- diode mixers.



1.2 Features

- High fundamental rejection
- Millimeter wave output frequencies
- +21 dBm 4F output Power
- +5V/-5V Bias

1.3 Applications

- High frequency synthesis
- LO drive for S-diode mixers
- LO signal chain

1.4 Electrical Summary

Parameter	Typical	Unit
Input Frequency Range	5.25 - 14	GHz
Output Frequency Range	21 - 56	GHz
Input Power	-2 to +6	dBm
4F Output Power	+21	dBm
1F Harmonic suppression	49	dBc
2F Harmonic Suppression	36	dBc
3F Harmonic Suppression	32	dBc
5F Harmonic suppression	37	dBc

1.5 Functional Block Diagram

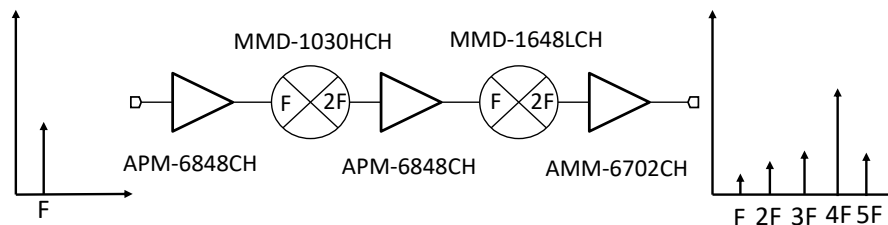

1.6 Part Ordering Options¹

Part Number	Description	Green Status	Product Lifecycle	Export Classification
AQA-2156	Connectorized Module	RoHS	Active	EAR99

¹ Refer to our [website](#) for a list of definitions for terminology presented in this table.

Table of Contents

1. Device Overview	1	2.2 Port Functions	3
1.1 General Description	1	3. Specifications	4
1.2 Features	1	3.1 Absolute Maximum Ratings.....	4
1.3 Applications	1	3.2 Sequencing Requirements	4
1.4 Electrical Summary.....	1	3.3 Heat Sinking	4
1.5 Functional Block Diagram	1	3.4 Electrical Specifications	5
1.6 Part Ordering Options.....	1	3.5 Typical Performance Plots	6
2. Port Configurations and Functions	3	4. Mechanical Data	8
2.1 Port Diagram.....	3	4.1 Outline Drawing	8

Revision History

Revision Code	Revision Date	Comment
-	April 2020	Initial Release Datasheet
A	July 2020	Updated Min Output Power and Suppression Specs
B	August 2020	Inclusion of internal chipset

2. Port Configurations and Functions

2.1 Port Diagram

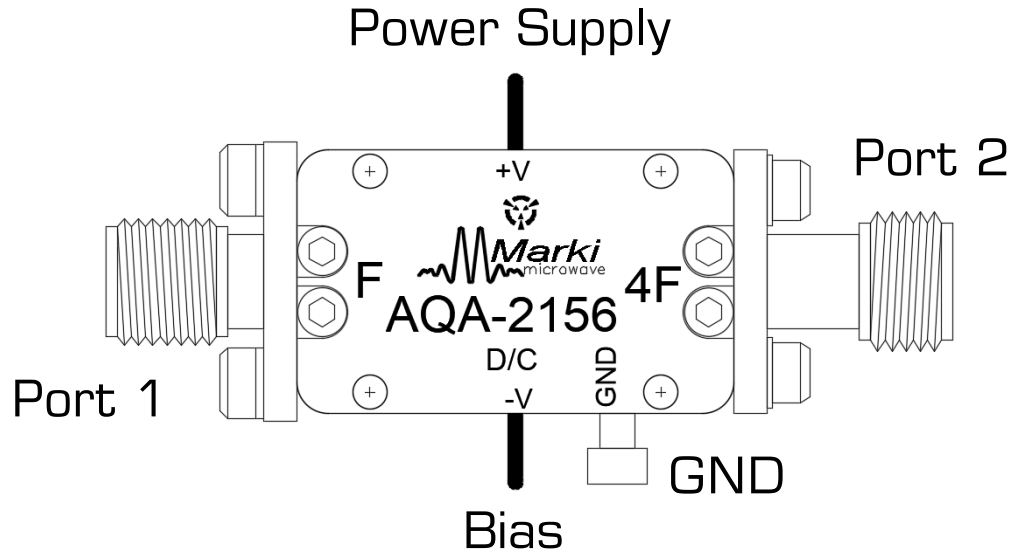

2.2 Port Functions

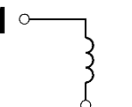
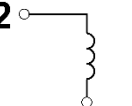
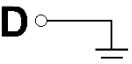
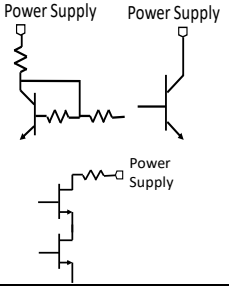
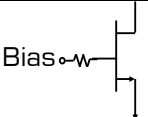
Port	Function	Description	Equivalent Circuit
Port 1	Input	This pin is for the RF input. It is internally DC-blocked and is matched to 50 ohms from 5.25-14 GHz	P1 
Port 2	Output	This pin is for the RF output. It is internally DC-blocked matched to 50 ohms from 21-56 GHz	P2 
GND	Ground	Ground path is provided through the metal housing and outer ground lug.	GND 
Power Supply	Positive bias	Positive bias port must be connected to a +4.0 to +5.0 Volt power supply.	
Bias	Negative bias	Gate control for the amplifier must be connected to a -5.0 to -6.0 Volt power supply.	

3. Specifications

3.1 Absolute Maximum Ratings

The Absolute Maximum Ratings indicate limits beyond which damage may occur to the device. If these limits are exceeded, the device may be inoperable or have a reduced lifetime.

Absolute Maximum Ratings	
Parameter	Maximum Rating
Positive Bias Voltage	6 V
Positive Bias Current	1 A
Negative Bias Voltage	-10 V
Negative Bias Current	2 mA
RF Input Power	+20 dBm
ESD (Human Body Model)	Class 1A
Operating Temperature	-55°C to +85°C
Storage Temperature	-65°C to +150°C

3.2 Sequencing Requirements

Turn-on Procedure:

- 1) Apply -5V to Bias port
- 2) Apply +5V to Power Supply port

Turn-off Procedure:

- 1) Turn off Power Supply port
- 2) Turn off Bias port

3.3 Heat Sinking

We have observed non-catastrophic self-heating in normal +5V/-5V operation which may result in decreased output power. To maintain peak performance, we recommend using a heat sink with the AQA-2156 module.

3.4 Electrical Specifications

The electrical specifications apply at $T_A=+25^{\circ}\text{C}$ in a 50Ω system.

Parameter	Test Conditions	Min	Typical	Max	Units
Input (Port 1) Frequency Range		5.25		14	GHz
Output (Port 2) Frequency Range		21		56	
Input Power ²		-2	+2	+6	dBm
4F Output Power	Input = 5.25 – 14 GHz Output = 21 - 56 GHz	13	21		dB
Suppression ³	1F Input = 5.25 – 14 GHz Output = 5.25 – 14 GHz	30	49		dBc
	2F Input = 5.25 – 14 GHz Output = 10.5 - 28 GHz	15	36		
	3F Input = 5.25 – 14 GHz Output = 15.75 - 42 GHz	12	32		
	5F Input = 5.25 – 13.4 GHz Output = 26.25 - 67 GHz	17	37		
Bias Requirements ⁴ Power Supply: +5.0 Volts DC Bias: -5.0 Volts DC			378 0.001		mA

² Optimal suppression levels at +2 dBm input power

³ Suppression is defined as the harmonic power relative to the 4F quadrupled output power

⁴ Current consumption taken under NO RF input power. Current draw will increase with increased input power.

3.5 Typical Performance Plots

4F Output Converted Power (dBm) vs. Output Frequency, Over Various Input Powers

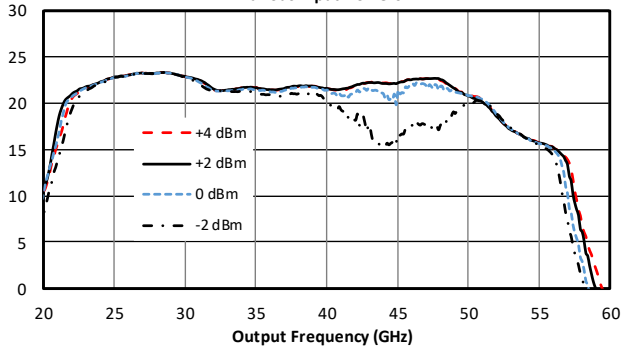

1F Output Suppression (dBc) vs. Output Frequency, Over Various Input Powers

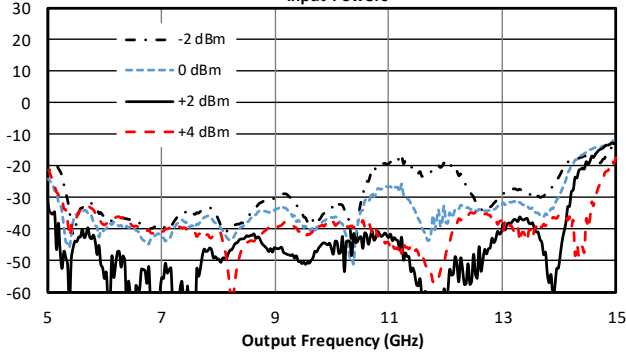

2F Output Suppression (dBc) vs. Output Frequency, Over Various Input Powers

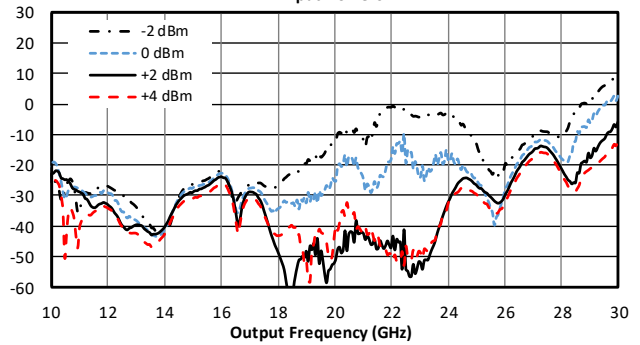

3F Output Suppression (dBc) vs. Output Frequency, Over Various Input Powers

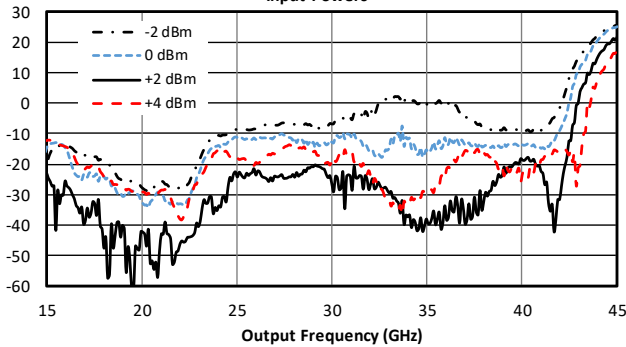

5F Output Suppression (dBc) vs. Output Frequency, Over Various Input Powers

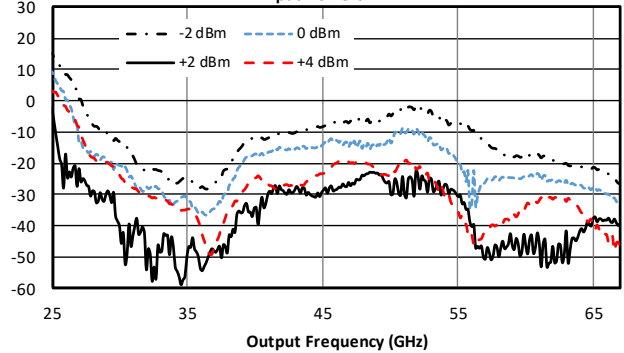

Input Return Loss (dB) vs. Input Frequency

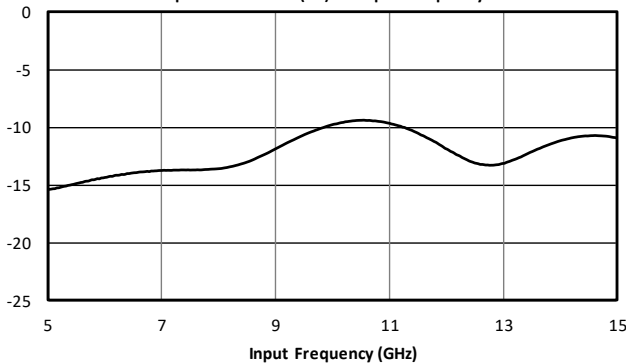

Output Return Loss (dB) vs. Output Frequency

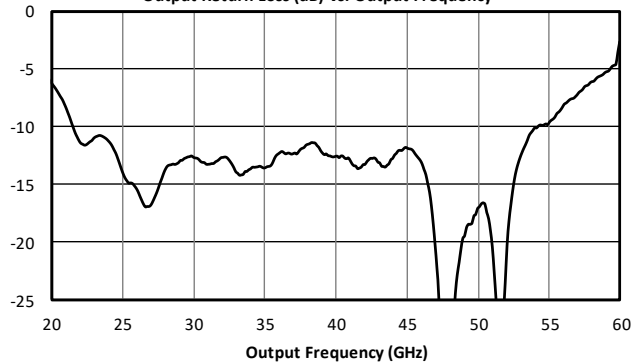

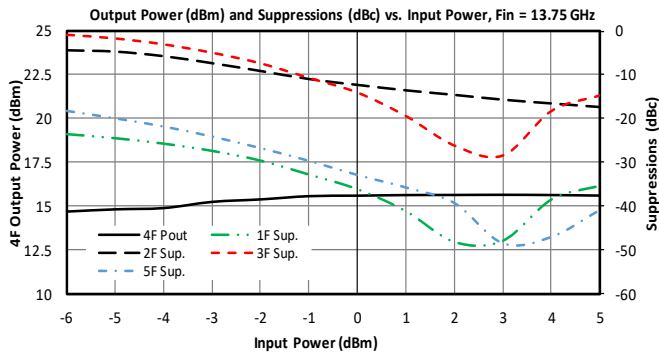
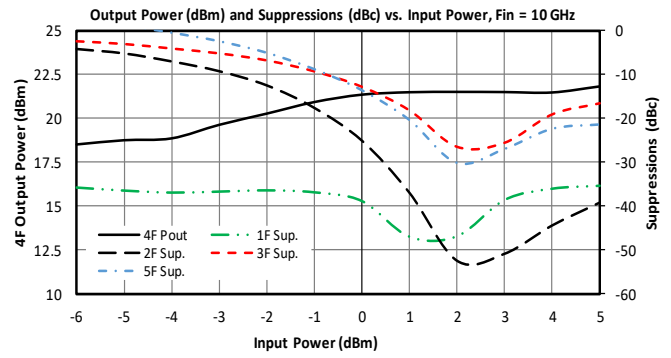
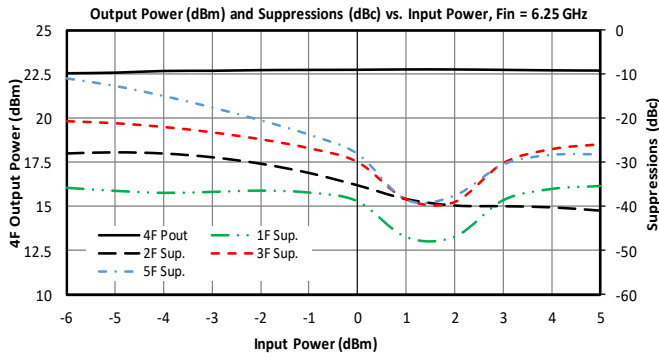

4. Mechanical Data

4.1 Outline Drawing

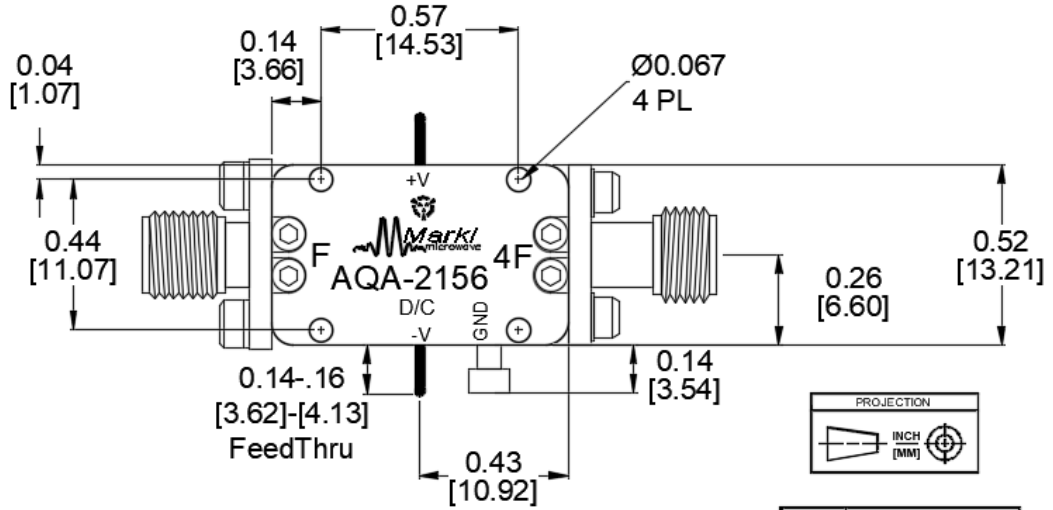

Port	Connector Type
F	SMA Female
4F	1.85 mm Female

*Note: All measurements are typical

