

1 GHz – 22 GHz Low Phase Noise Amplifier

APM-7516

1. Device Overview

1.1 General Description

The APM-7516 is a robust broadband distributed, low phase noise LO driver amplifier designed to provide greater than +20 dBm output power with excellent return losses and high input power handling. This amplifier uses GaAs HBT technology for low phase noise and is optimized to provide enough power to drive the LO port of an S-diode mixer from 1 GHz to 18 GHz or of an H or L diode mixer from 1 GHz to 22 GHz. This amplifier can be operated with a variety of bias conditions for both low power and high-power applications.



PA Module

1.2 Features

- -164 dBc/Hz phase noise at 10 kHz offset frequency
- +20 dBm output power up to 18 GHz
- High Linearity (+33 dBm OIP3)
- Excellent Return Losses
- +20 dBm Input Power Handling
- Positive-only biasing
- S-Parameters: [APM-7516](#)

1.3 Applications

- Mobile test and measurement equipment
- Radar and satellite communications
- 5G Transceivers
- Driver amplifier for S, H, and L – diode mixers

1.4 Functional Block Diagram

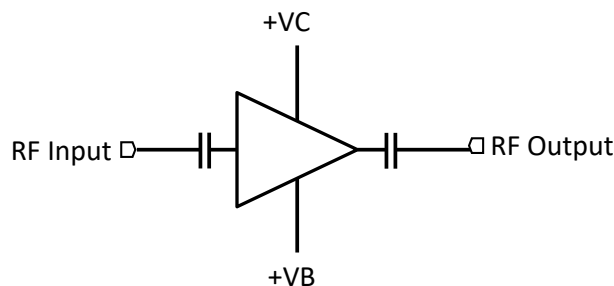

1.5 Part Ordering Options¹

Part Number	Description	Package	Green Status	Product Lifecycle	Export Classification
APM-7516PA	Connectorized Module	PA	RoHS	Active	EAR99

¹ Refer to our [website](#) for a list of definitions for terminology presented in this table.

Table of Contents

1. Device Overview	1	3.1 Absolute Maximum Ratings.....	4
1.1 General Description.....	1	3.2 Recommended Operating Conditions .	5
1.2 Features	1	3.3 Sequencing Requirements	5
1.3 Applications	1	3.4 Electrical Specifications	6
1.4 Functional Block Diagram	1	3.5 APM-7516PA Typical Performance	
1.5 Part Ordering Options.....	1	Plots.....	7
2. APM-7516 Port Configurations and		3.7 Typical Performance Plots of Marki	
Functions	3	Mixers with APM-7516PA LO Driver ...	10
2.1 APM-7516PA Port Diagram.....	3	3.8 Time Domain Plots.....	11
2.2 APM-7516PA Port Functions	3	4. Mechanical Data.....	12
3. Specifications	4	4.1 APM-7516PA Package Outline	
		Drawing	12

Revision History

Revision Code	Revision Date	Comment
-	February 2022	Initial Datasheet Release



2. APM-7516 Port Configurations and Functions

2.1 APM-7516PA Port Diagram

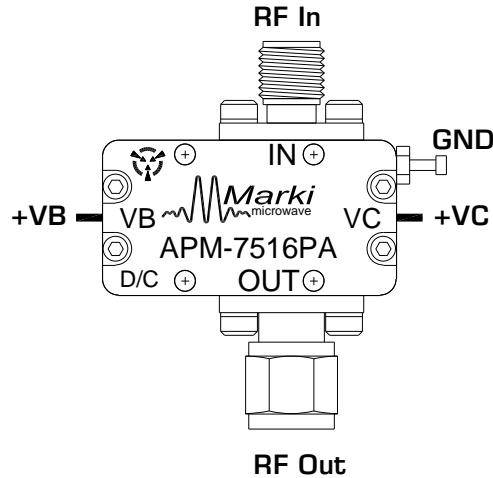
A port diagram of the APM-7516PA is shown below.

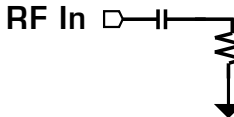
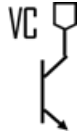
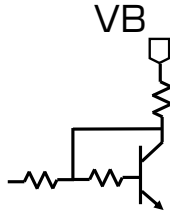
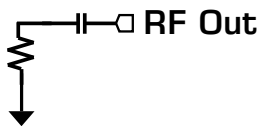

2.2 APM-7516PA Port Functions

Port	Function	Description	Equivalent Circuit for Package
RF In	RF Input	This is the RF Input port of the amplifier die. It is RF matched to 50 Ω , and has built-in DC blocking capacitors.	
VC	Collector DC Supply Port	Port VC is the DC voltage supply that supplies the amplifier's collector current. It is connected directly to the VC port on the amplifier IC.	
VB	Base Current Mirror Bias Port	Port VB is the DC voltage bias for the current mirror that controls collector current supplied to the amplifier. Larger voltages result in a higher current draw through port VC, effectively functioning as a gain control pin of the amplifier. See section 3.6 for performance at different bias conditions.	
RF Out	RF Output	This is the amplifier's RF Output. It is RF matched to 50 Ω and has built-in DC blocking capacitors. Must have less than 7:1 VSWR when operating.	
GND	Ground	Housing or outside of the coaxial cables must be connected to a DC/RF ground potential with high thermal and electrical conductivity.	

3. Specifications

3.1 Absolute Maximum Ratings

The Absolute Maximum Ratings indicate limits beyond which damage may occur to the device. If these limits are exceeded, the device may become inoperable or have a reduced lifetime.

Parameter	Maximum Rating	Units
Collector Positive Bias Voltage (VC)	6	V
Positive Bias Current (Ic)	240	mA
Positive DC Current Mirror Voltage (VB)	6	V
Positive DC Current Mirror Current (Ib)	15	mA
RF Input Power	+20	dBm
Output Load VSWR	7:1	-
Operating Temperature	-40 to +85	°C
Storage Temperature	-65 to +150	°C
θ_{Ja} , Junction to Ambient Thermal Resistance	33	°C /W
Continuous Power dissipation (P _{DISS}) (at 85 °C case temp.)	1.2	W
Max Junction Temperature for MTTF > 1E6 hours	125	°C

3.2 Recommended Operating Conditions

The Recommended Operating Conditions indicate the limits, inside which the device should be operated, to guarantee the performance given in Electrical Specifications. Operating outside these limits may not necessarily cause damage to the device, but the performance may degrade outside the limits of the electrical specifications. For limits, above which damage may occur, see Absolute Maximum Ratings.

Parameter	Value	Units
Positive DC Voltage (VC)	+5	V
Positive DC Current (Ic) ²	106	mA
Positive DC Current Mirror Voltage (VB)	+5	V
Positive DC Current Mirror Current (Ib) ²	5	mA

3.3 Sequencing Requirements

There is no sequencing required to power up or power down the amplifier.

Amplifier must have an output load connected when operating.

² Recommended operating current conditions given without RF input applied. Please see typical performance plots on page 12 for relationship between RF input power and DC current draw.

3.4 Electrical Specifications

The electrical specifications apply at $T_A=+25^{\circ}\text{C}$ in a 50Ω system.

Min and Max limits apply only to our connectorized units and are guaranteed at $T_A=+25^{\circ}\text{C}$.

Parameter	Test Conditions	Frequency	Min	Typical	Units
5 dB Saturated Output Power P_{5dB}	5V/5V bias	1 – 3 GHz		+23	dBm
		3 – 15 GHz	+19	+23	
		15 – 22 GHz		+20	
Small Signal Gain	5V/5V bias -15 dBm Input Power	1 – 3 GHz		12	dB
		3 – 15 GHz	10	12.5	
15 – 22 GHz			11		
Input Return Loss		1 – 22 GHz		18	
Output Return Loss		1 – 22 GHz		20	
Reverse Isolation		1 – 22 GHz		34	
Noise Figure	5V/5V bias, -30 dBm Input Power	1 – 22 GHz		5.1	
Collector Current, I_c	5V/4V	-		74	mA
	5V/5V			106	
	5V/6V			141	
Current Mirror Current, I_b	5V/4V			4	
	5V/5V			5	
	5V/6V			7	
Input IP3 (IIP3)	5V/5V -15 dBm Input Power	1 – 22 GHz		+21	dBm
Output IP3 (OIP3)		1 – 22 GHz		+33	
Output P_{1dB}	5V/5V	1 – 22 GHz		+18	
Input Power for Saturation	5V/5V	1 – 22 GHz		+12	
Phase Noise @ 10 kHz Offset	+13 dBm Input power	4 GHz		-164	dBc/Hz

3.5 APM-7516PA Typical Performance Plots

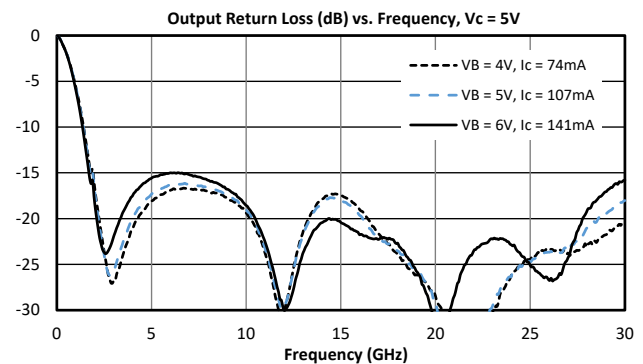
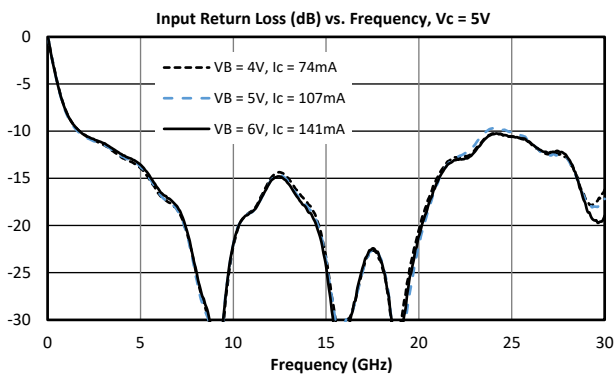
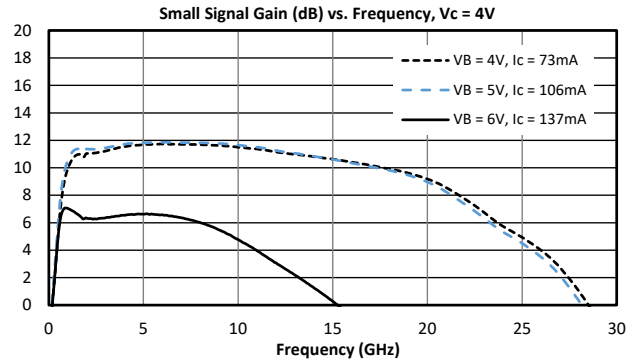
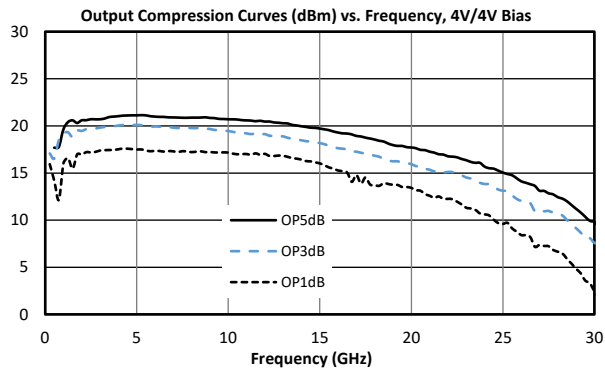
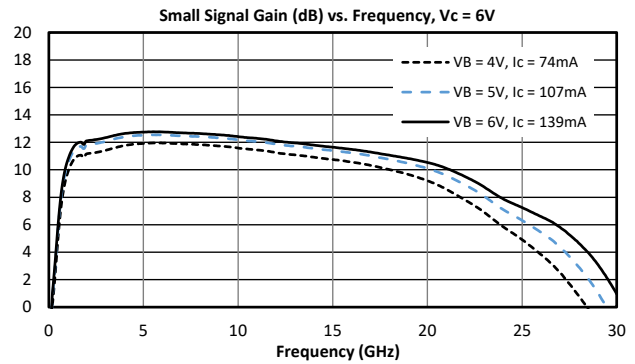
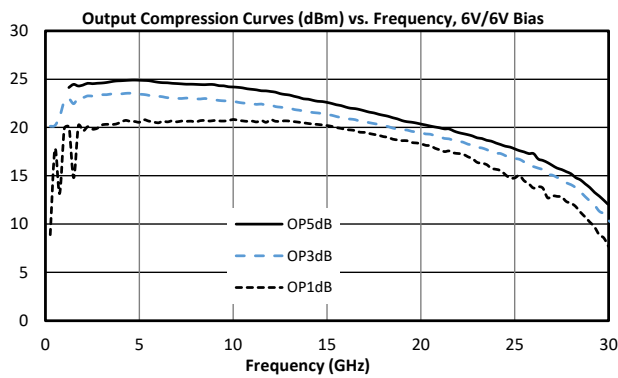
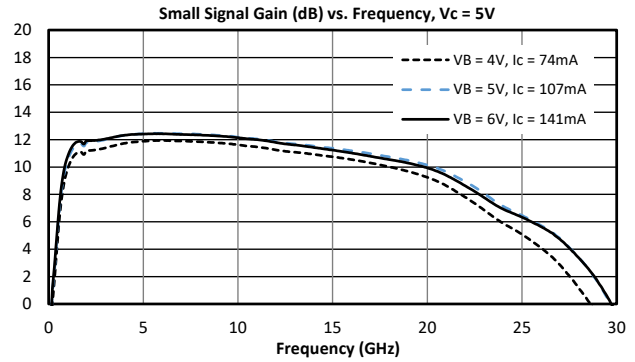
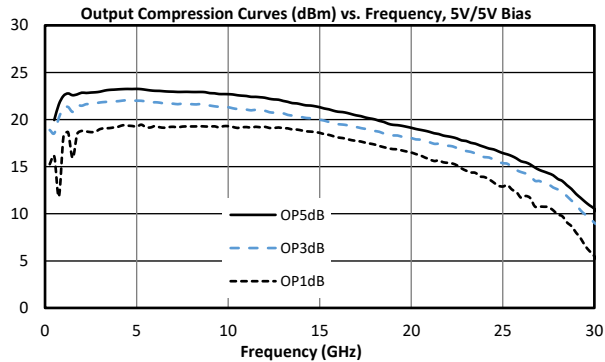

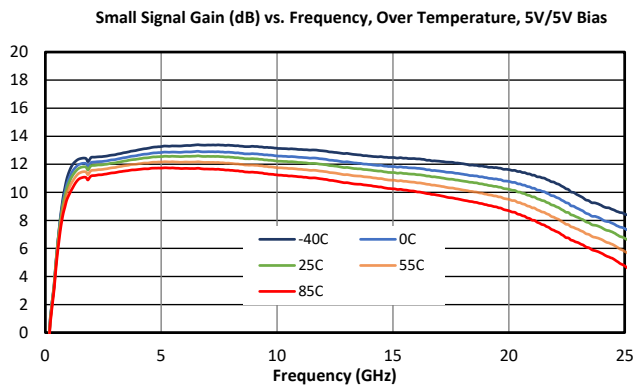
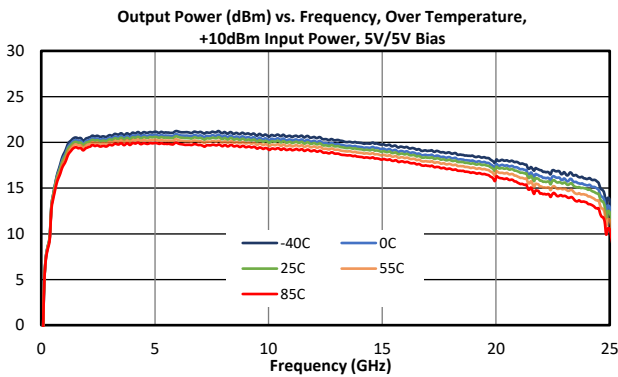
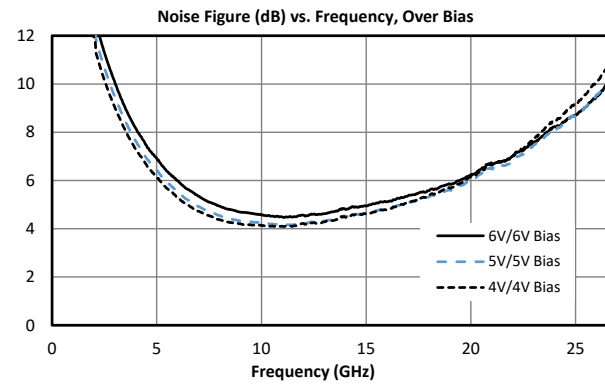
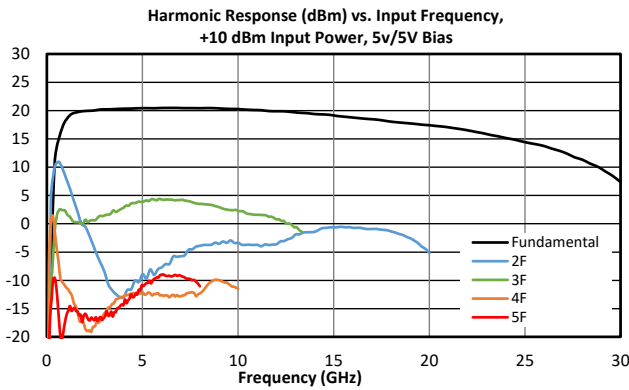
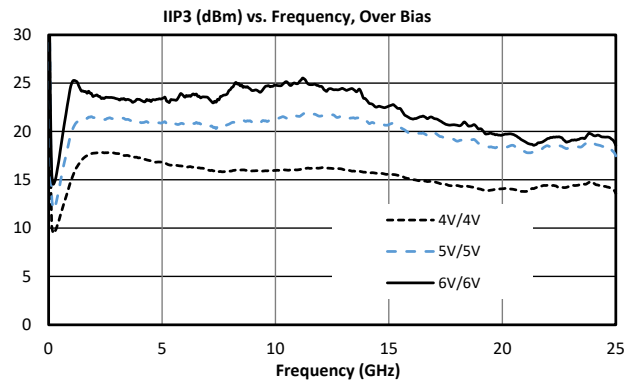
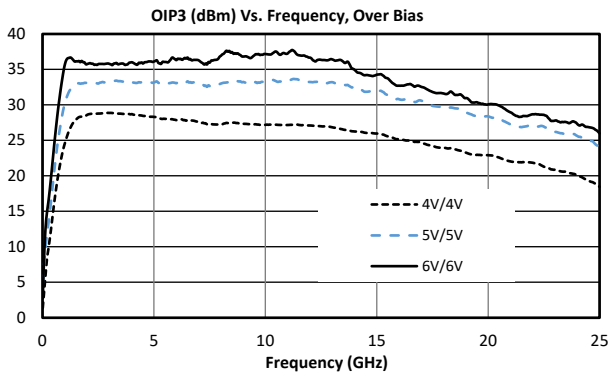
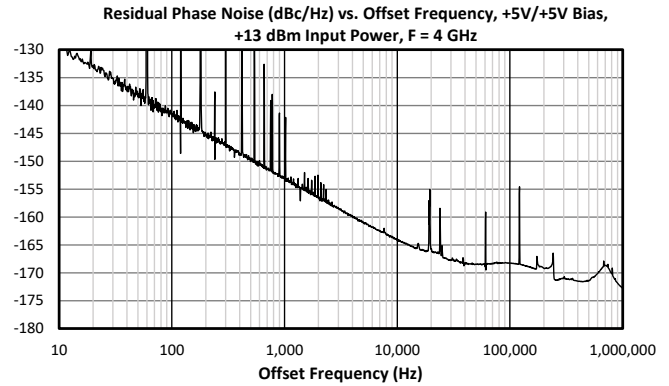
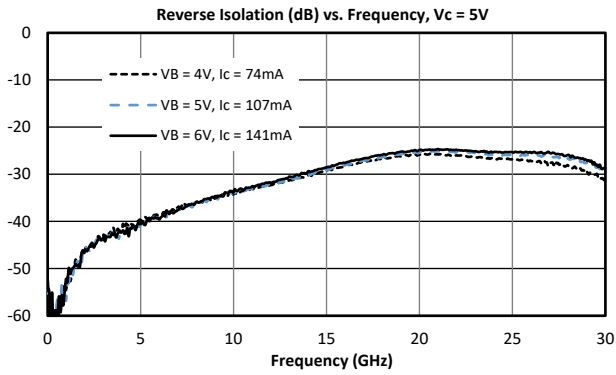

Output Power (dBm), Gain (dB), and PAE (%) vs. Input Power, F = 5 GHz, 5V/5V Bias

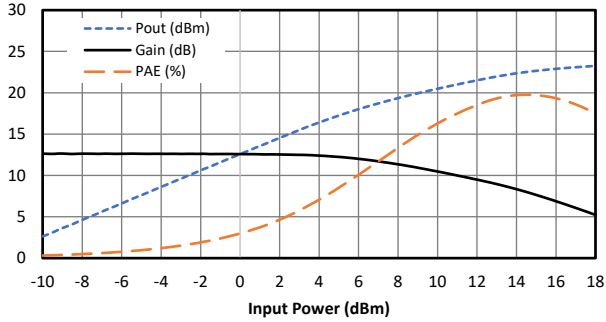

Output Power (dBm), Gain (dB), and PAE (%) vs. Input Power, F = 10 GHz, 5V/5V Bias

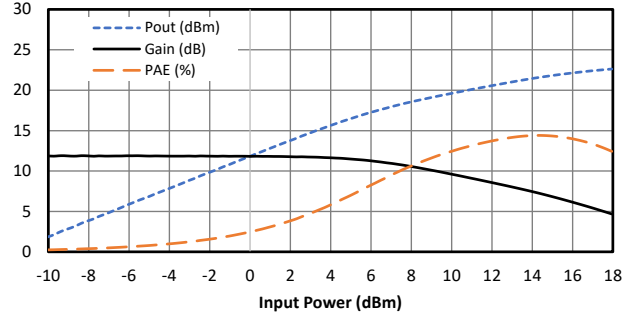

Output Power (dBm), Gain (dB), and PAE (%) vs. Input Power, F = 15 GHz, 5V/5V Bias

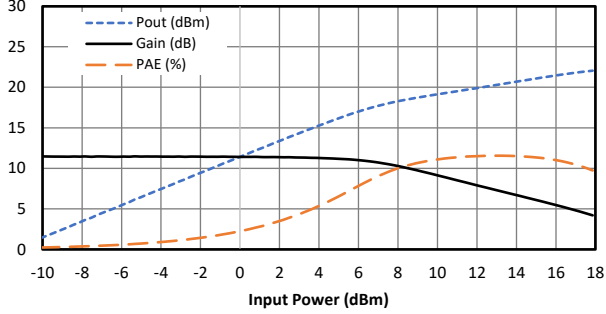

Collector Current (mA) vs. RF Input Power, Over Frequency, 5V/5V Bias

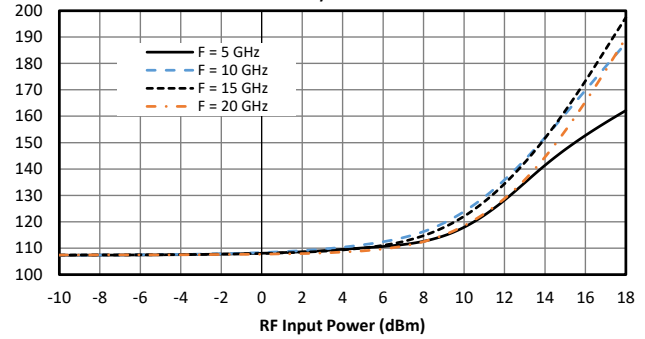

Ic, Ib (mA) vs. Vb (V) (Vc = 5V)

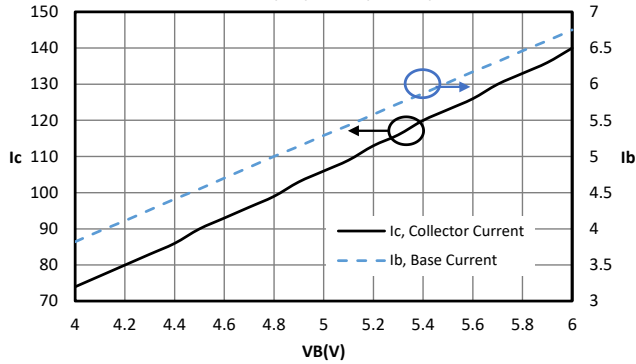

3.7 Typical Performance Plots of Marki Mixers with APM-7516PA LO Driver

MM1-0626S Config A Conv. Loss (dB) vs. Frequency, APM-7516PA LO Driver, 5V/5V Bias, 91 MHz IF Freq.

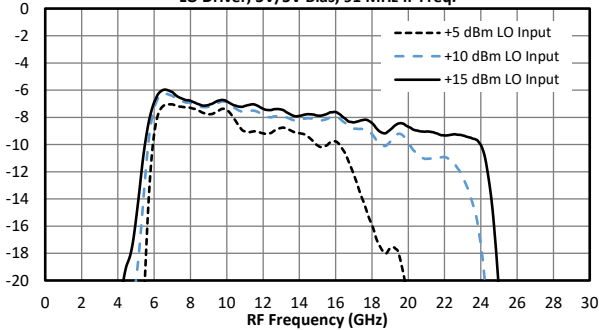

MM1-0626S IIP3 (dBm) vs. Frequency, APM-7516PA LO Driver, 5V/5V Bias, 91 MHz IF Freq.

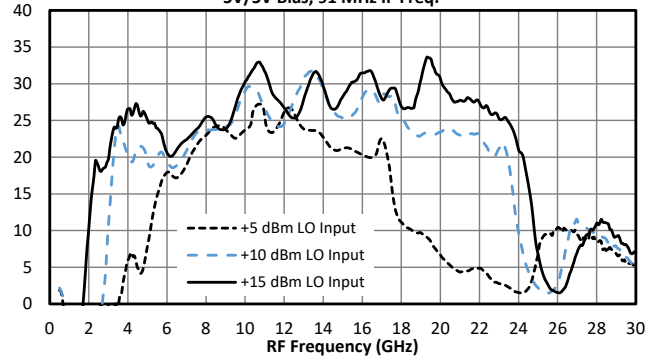

MM1-0222H Config A Conv. Loss (dB) vs. Frequency, APM-7516PA LO Driver, 5V/5V Bias, 91 MHz IF Freq.

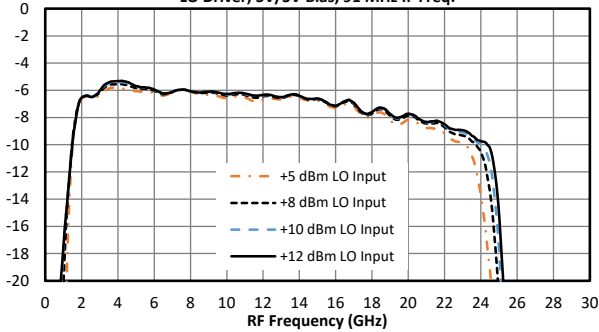

MM1-0222H IIP3 (dBm) vs. Frequency, APM-7516PA LO Driver, 5V/5V Bias, 91 MHz IF Freq.

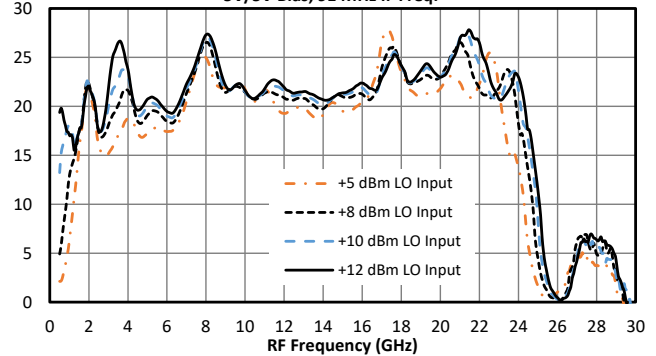

MM1-0312S Config A Conv. Loss (dB) vs. Frequency, APM-7516PA LO Driver, 5V/5V Bias, 91 MHz IF Freq.

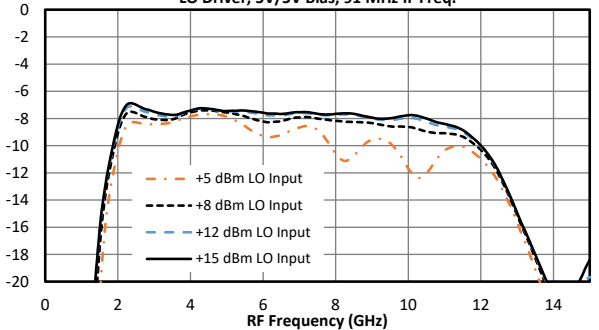

MM1-0312S IIP3 (dBm) vs. Frequency, APM-7516PA LO Driver, 5V/5V Bias, 91 MHz IF Freq.

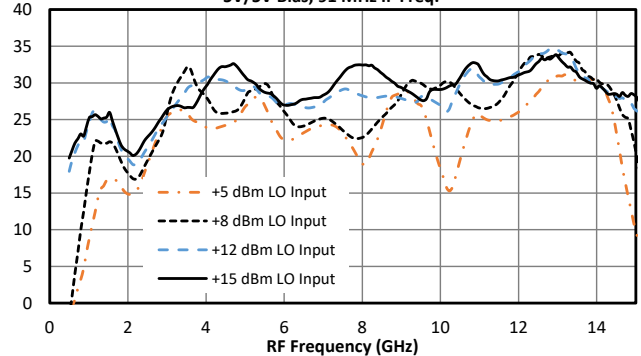

3.8 Time Domain Plots

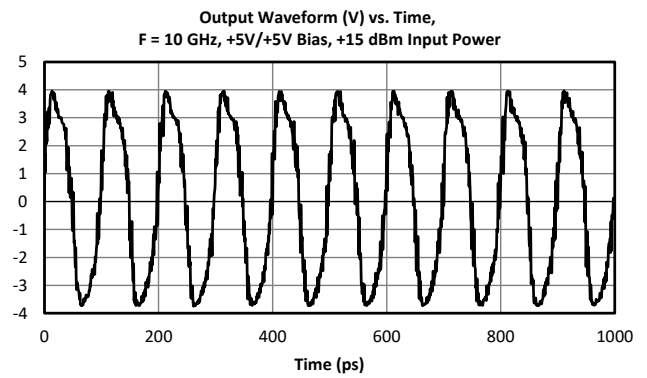
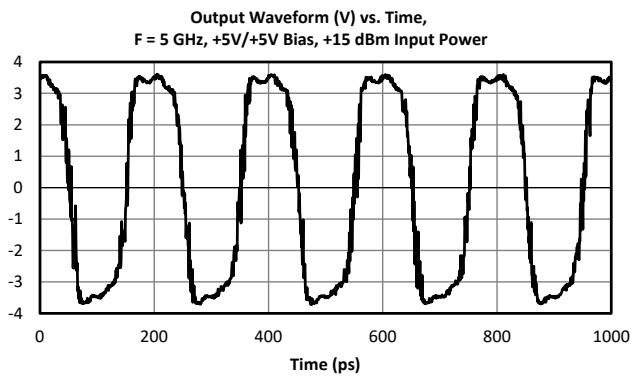
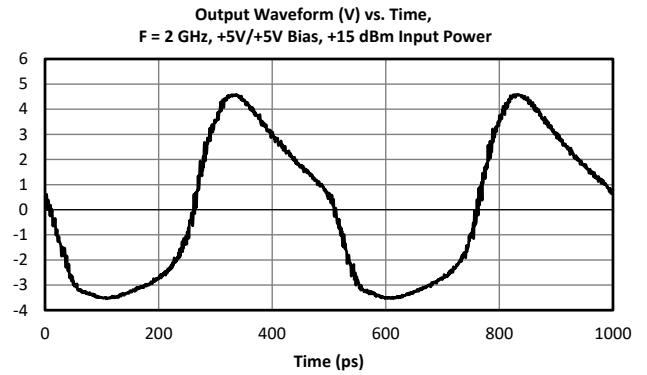
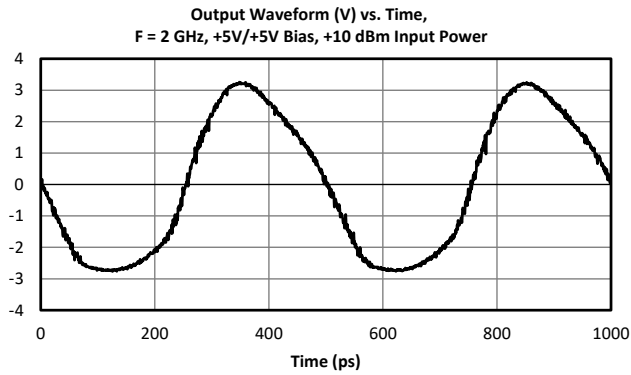

4. Mechanical Data

4.1 APM-7516PA Package Outline Drawing

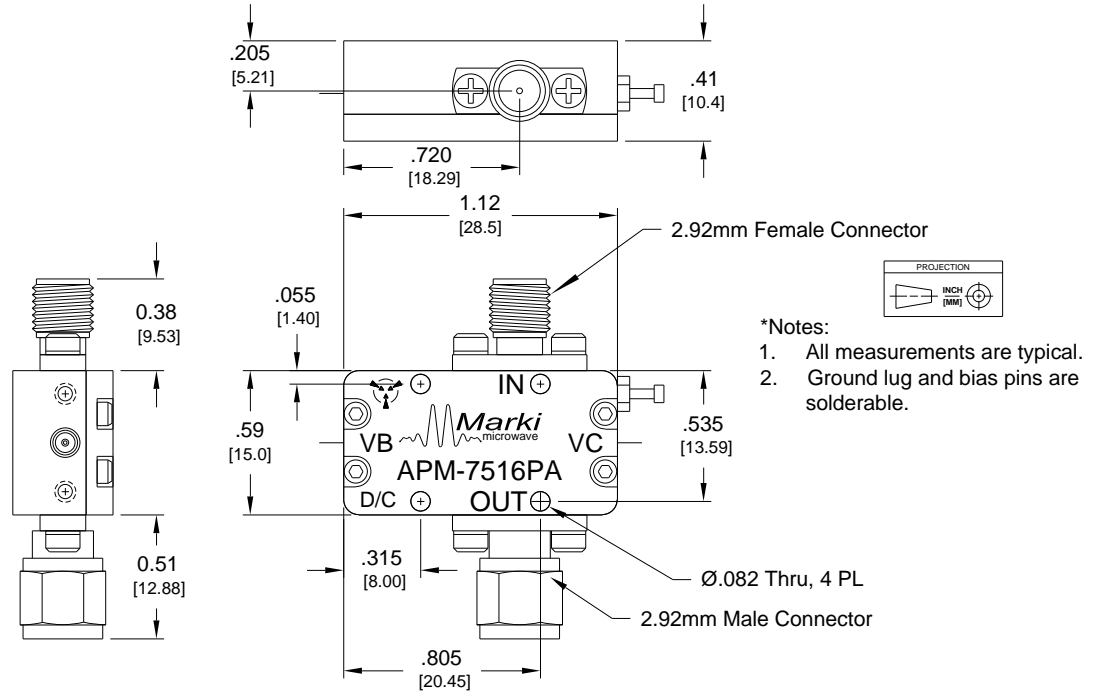

Marki Microwave reserves the right to make changes to the product(s) or information contained herein without notice. Marki Microwave makes no warranty, representation, or guarantee regarding the suitability of its products for any particular purpose, nor does Marki Microwave assume any liability whatsoever arising out of the use or application of any product