

DC – 14 GHz Broadband InGaP SMT Amplifier

AKA-1500PSM

1. Device Overview

1.1 General Description

The AKA-1500PSM is a low-cost, cascadable broadband InGaP HBT amplifier. This is a general-purpose gain block amplifier which provides high P1dB, high OIP3, and a very small form factor. The simple application circuit requires minimal external components, allowing it to be used in a variety of applications.

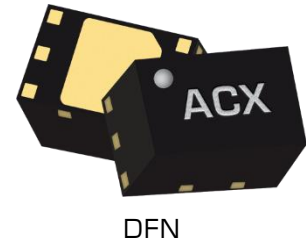

1.2 Features

- Small Form Factor: 1.3 x 2.0mm
- +28 dBm OIP3 up to 6 GHz
- 18.5 dB Gain at 2 GHz
- Positive Only, Single Supply Operation
- Low-Cost
- [AKA-1500PSM S-parameters](#)

1.3 Applications

- Mobile test and measurement equipment
- Radar and satellite communications
- 5G Transceivers
- Driver Amplifier L-Diode Mixers

1.4 Functional Block Diagram

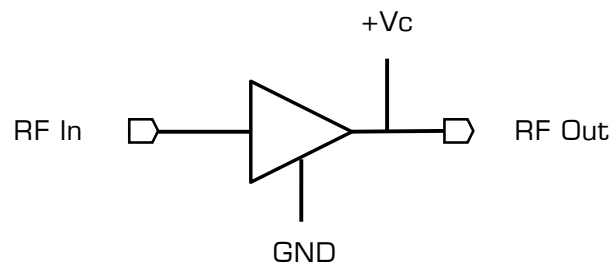

1.5 Part Ordering Options¹

Part Number	Description	Package	Green Status	Product Lifecycle	Export Classification
AKA-1500PSM	1.3 x 2.0 mm Surface Mount	DFN	RoHS	Active	EAR99
EVB-AKA-1500P	Connectorized Evaluation Fixture	EVAL	RoHS	Active	EAR99

¹ Refer to our [website](#) for a list of definitions for terminology presented in this table.

Table of Contents

1. Device Overview	1	3.2 Package Information	4
1.1 General Description	1	3.3 Recommended Operating Conditions ..	5
1.2 Features	1	3.4 Sequencing Requirements	5
1.3 Applications	1	3.5 Electrical Specifications	6
1.4 Functional Block Diagram	1	3.6 AKA-1500PSM Typical Performance Plots.....	7
1.5 Part Ordering Options.....	1	4. Application Information	9
2. AKA-1500PSM Port Configurations and Functions	3	4.1 AKA-1500PSM Application Circuit ...	9
2.1 AKA-1500PSM Port Diagram.....	3	5. Mechanical Data	10
2.2 AKA-1500PSM Port Functions.....	3	5.1 AKA-1500PSM Outline Drawing	10
3. Specifications	4	5.2 AKA-1300PSM Recommended Landing Pattern	10
3.1 Absolute Maximum Ratings.....	4	5.3 EVB-AKA-1500P Outline Drawing ..	11

Revision History

Revision Code	Revision Date	Comment
-	April 2023	Datasheet Initial Release



2. AKA-1500PSM Port Configurations and Functions

2.1 AKA-1500PSM Port Diagram

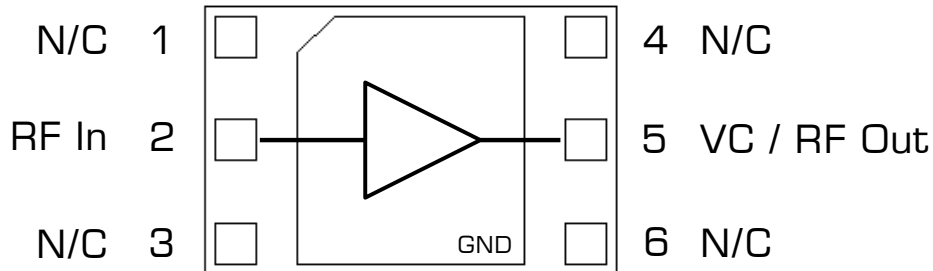
A port diagram of the AKA-1500PSM is shown below.

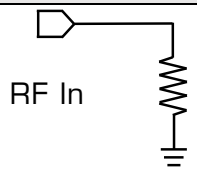
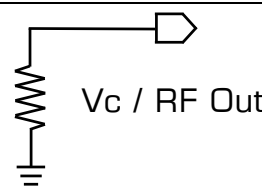

2.2 AKA-1500PSM Port Functions

Pin	Function	Description	Equivalent Circuit for Package
2	RF Input	This is the RF Input port of the amplifier die. It is RF matched to 50 Ω and requires an external DC blocking capacitor.	
5	RF Output and Positive Collector Voltage Supply	This is the RF Output and positive supply voltage port Vc. It is RF matched to 50 Ω and is DC coupled. An external bias tee is required on this port.	
Paddle	Ground	Package ground paddle must be connected to a DC/RF ground potential with high thermal and electrical conductivity.	
1, 3, 4, 6	N/C	These pins are internally no-connects and should be connected to DC/RF ground.	

3. Specifications

3.1 Absolute Maximum Ratings

The Absolute Maximum Ratings indicate limits beyond which damage may occur to the device. If these limits are exceeded, the device may become inoperable or have a reduced lifetime.

Parameter	Maximum Rating	Units
Positive Bias Current (I _{cc})	74	mA
RF Input Power	+10	dBm
Operating Temperature	-40 to +85	°C
Storage Temperature	-65 to +150	°C
Power Dissipation	308	mW
θ_{Jc} , Junction to Case Thermal Resistance	212	°C/W
Max Junction Temperature for MTTF > 1E6 hours	150	°C

3.2 Package Information

Parameter	Details	Rating
ESD	Human Body Model (HBM), per MIL-STD-750, Method 1020	1A
MSL	Moisture Sensitivity Level, per J-STD-020	MSL 1
Weight	AKA-1500PSM, 1.3 x 2.0 mm DFN Package	7 mg

3.3 Recommended Operating Conditions

The Recommended Operating Conditions indicate the limits, inside which the device should be operated, to guarantee the performance given in Electrical Specifications. Operating outside these limits may not necessarily cause damage to the device, but the performance may degrade outside the limits of the electrical specifications. For limits, above which damage may occur, see Absolute Maximum Ratings.

	Min	Nominal	Max	Units
T _A , Ambient Temperature	-40	+25	+85	°C
Positive DC Device Voltage (V _c)	+4.1	+4.2	+4.3	V
Positive DC Current (I _{cc})	35	50	60	mA

3.4 Sequencing Requirements

There is no sequencing required to power up or power down the amplifier.

3.5 Electrical Specifications

Unless otherwise specified, electrical specifications apply at $T_A=+25^\circ\text{C}$, $V_c = +4.2\text{V}$ in a 50Ω system. Typical performance data is measured from EVB unless otherwise stated.

Min and Max limits are guaranteed at $T_A=+25^\circ\text{C}$.

Parameter	Test Conditions	Frequency	Min	Typical	Units	
Small Signal Gain	$V_c = +4.2\text{ V}$, $I_{cc} = 50\text{ mA}$	0.1 – 4.0 GHz	17	19	dB	
		4.0 – 6.0 GHz	15	17		
		6.0 – 12.0 GHz	9	13		
		12.0 – 14.0 GHz	7	9		
Output P1dB		2.0 – 6.0 GHz	14	16	dBm	
		6.0 – 14.0 GHz	11	13		
Input Return Loss		0.1 – 14.0 GHz			14	dB
Output Return Loss					22	
Reverse Isolation					19	
Noise Figure			0.1 – 6.0 GHz			
	6.0 – 14 GHz			5		
Output IP3 (OIP3)	0.1 – 6.0 GHz			+28	dBm	
	6.0 – 14 GHz			+26		
DC Supply Quiescent Current (I_{cc})	$V_c = +4.2\text{V}$, No RF Input			50	mA	

3.6 AKA-1500PSM Typical Performance Plots

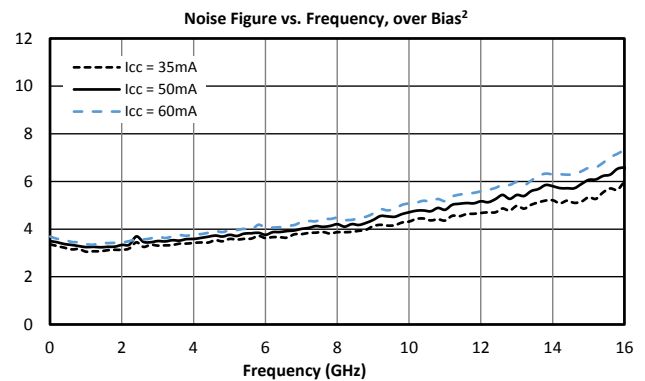
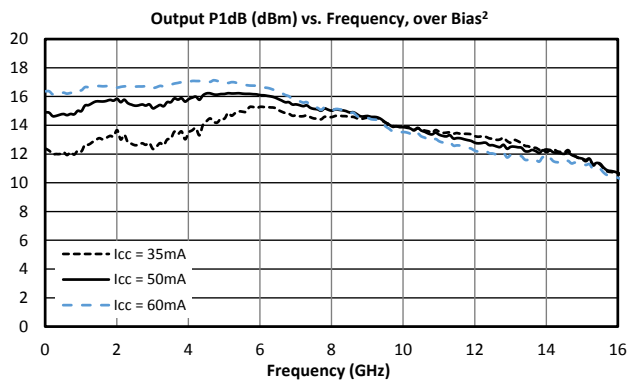
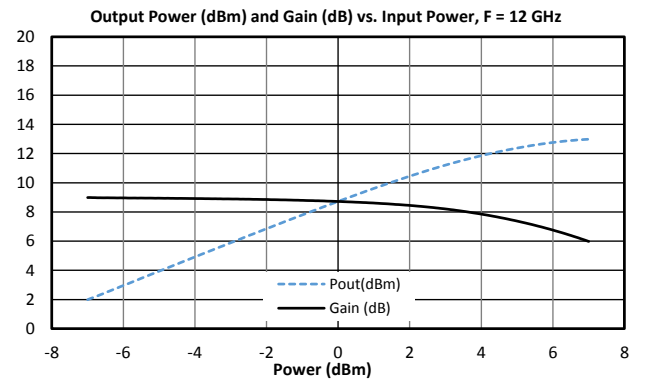
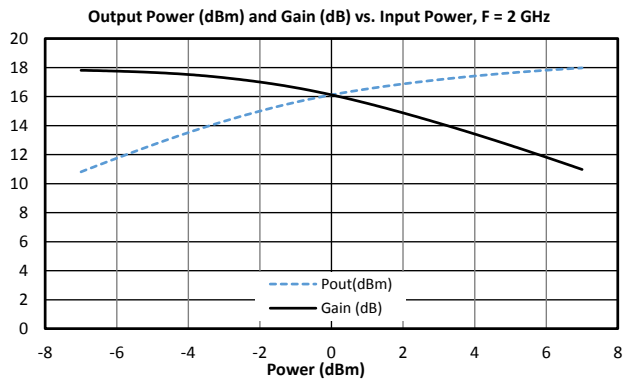
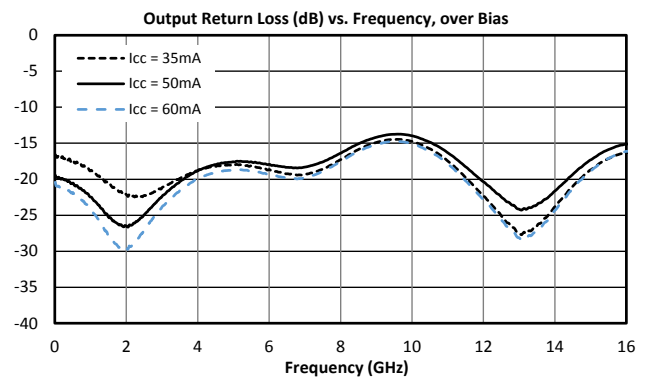
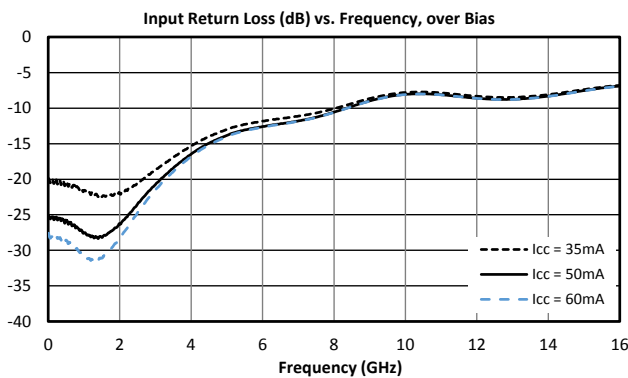
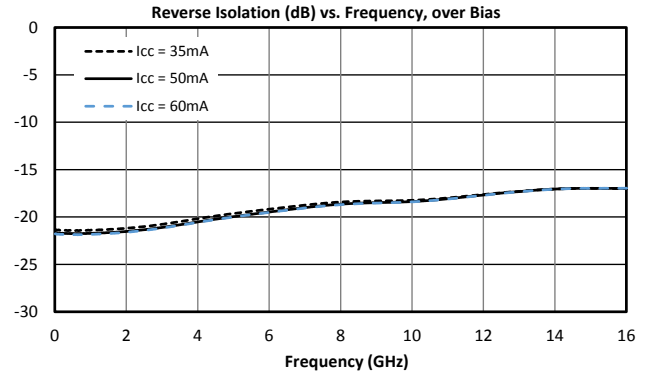
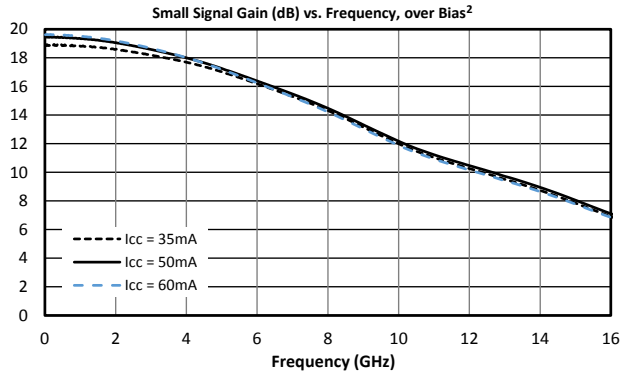

² Measured data is scalar de-embedded using a 2x thru fixture.

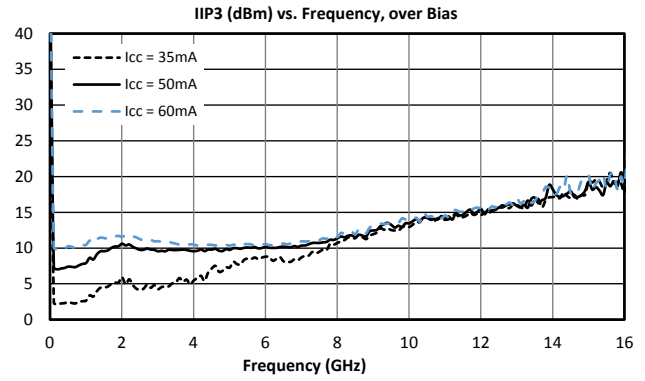
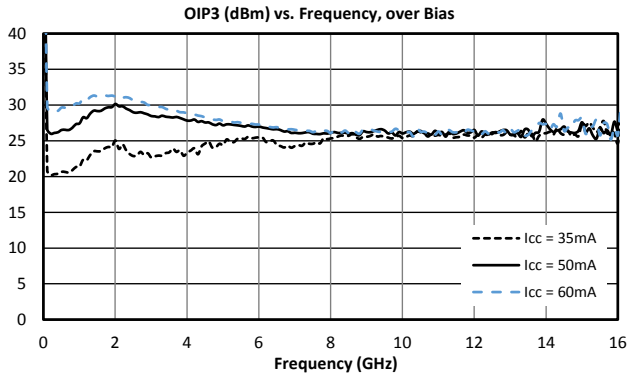

4. Application Information

4.1 AKA-1500PSM Application Circuit

Below is the recommended application circuit for the AKA-1500PSM.

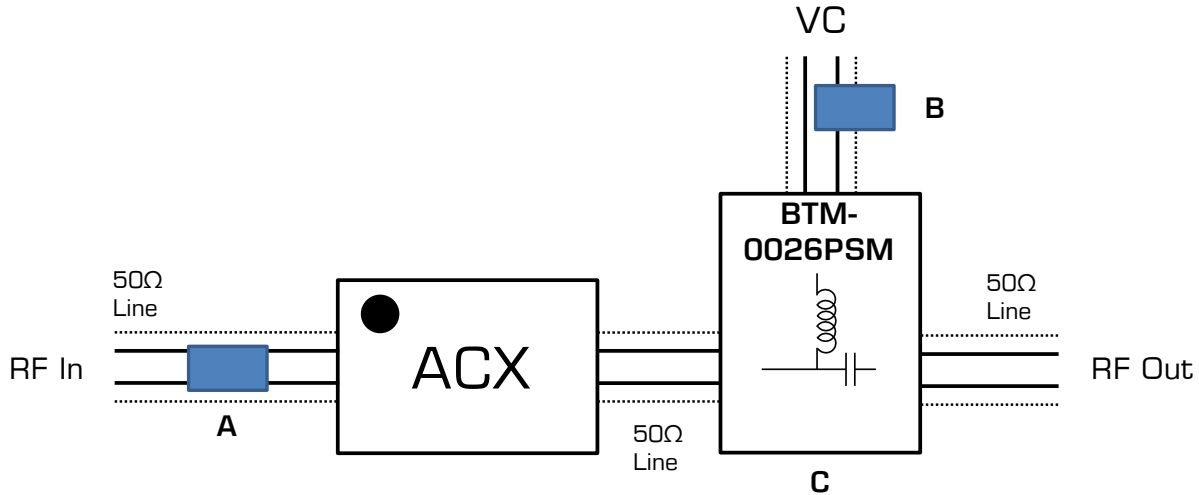

The RF input and output should be soldered to 50Ω traces. This amplifier requires external DC blocking on the input and output in addition to positive collector biasing on the output. The [BTM-0026PSM](#) is recommended to bias and DC the amplifier for its small 2.25 x 3.7mm footprint and excellent insertion loss performance.

Designator	Description	Sample Part Number
A	0201 0.1 μF SMT Capacitor	---
B	0201 0.1 μF SMT Capacitor	---
C	Marki Surface-Mount Mini Bias Tee; 10 MHz – 26 GHz	BTM-0026PSM

5. Mechanical Data

5.1 AKA-1500PSM Outline Drawing

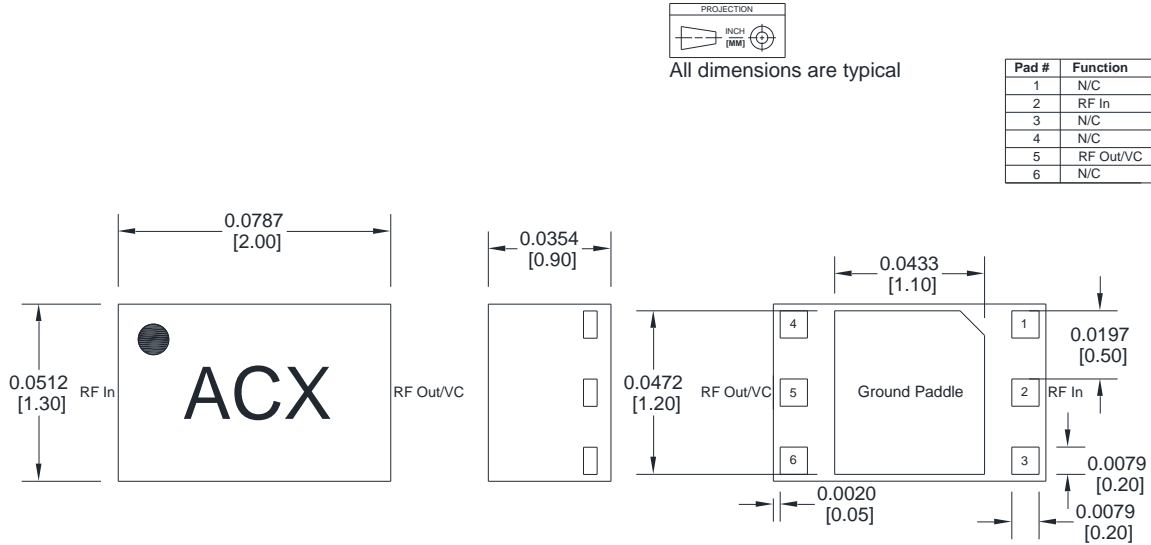

Notes (unless otherwise specified):

- Substrate material is LCP.
- I/O Leads and Die Paddle are (from base to finish):
 - Ni: 0.5 microns MIN
 - Pd: 0.02 microns MIN
 - Au: 0.05 microns MAX
- All unconnected pins should be connected to PCB RF ground.

5.2 AKA-1300PSM Recommended Landing Pattern

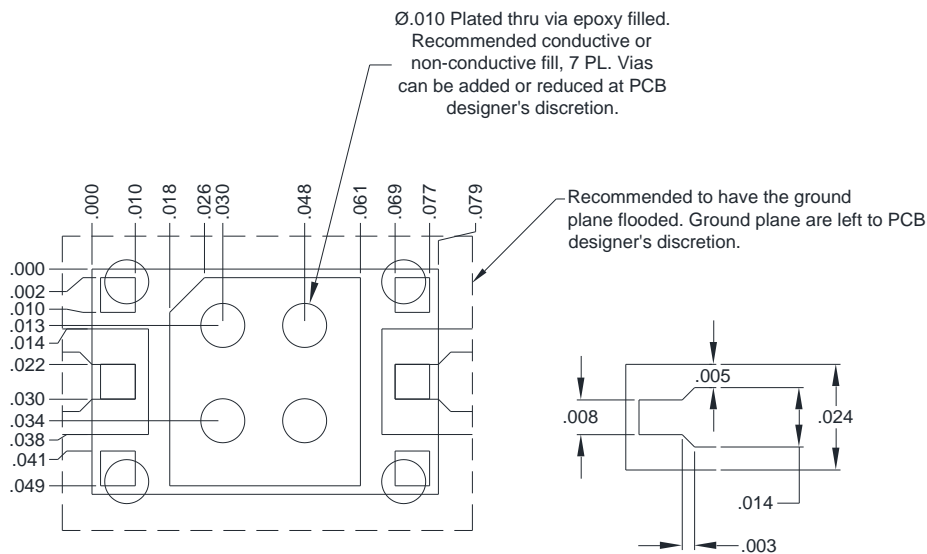

The landing pattern is to be used on Rogers 4003, 0.008" thick, 1/2 Oz Cu.

[DFN-Package Surface-Mount Landing Pattern](#)
[Click here for a DXF of the above layouts.](#)
[Click here for leaded solder reflow.](#) [Click here for lead-free solder reflow](#)

5.3 EVB-AKA-1500P Outline Drawing

All Dimensions are typical.

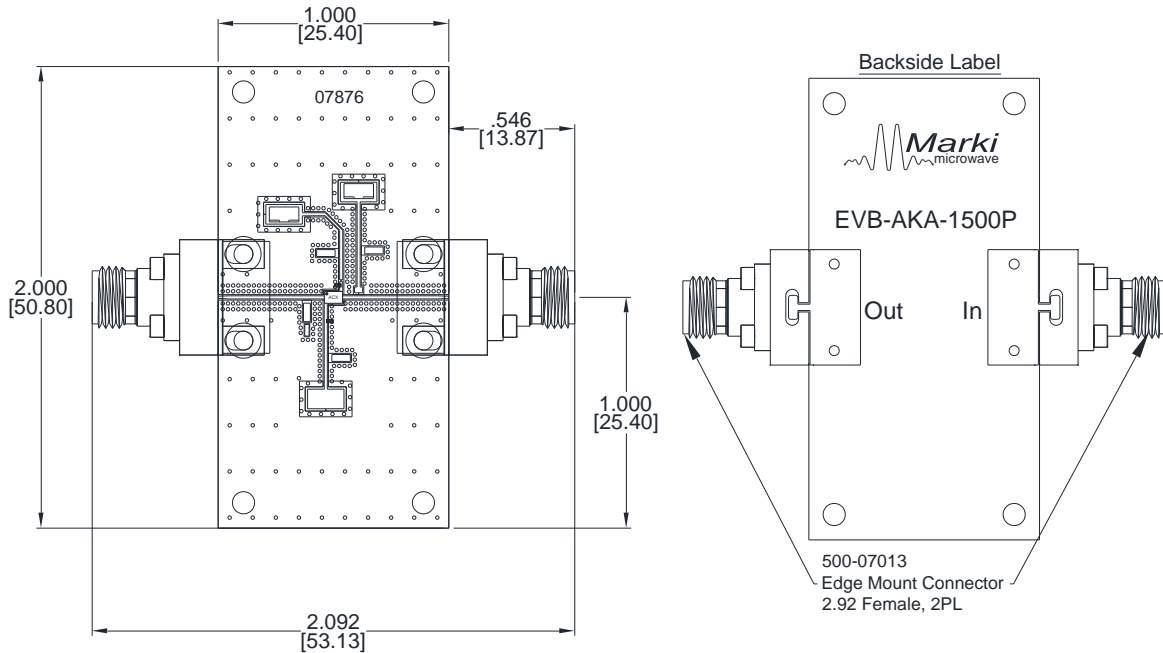
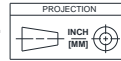

Marki Microwave reserves the right to make changes to the product(s) or information contained herein without notice.

Marki Microwave makes no warranty, representation, or guarantee regarding the suitability of its products for any particular purpose, nor does Marki Microwave assume any liability whatsoever arising out of the use or application of any product.