

0.09 - 10 GHz High Dynamic Range Gain Block

ADM-8095PSM

1. Device Overview

1.1 General Description

The ADM-8095PSM is a high-linearity low noise amplifier capable of providing +20 dBm output power up to 10 GHz. The ADM-8095PSM can serve either as a linear signal amplifier, or as a saturated driver amplifier for H- or S-diode mixers. The amplifier has excellent return losses and gain flatness.

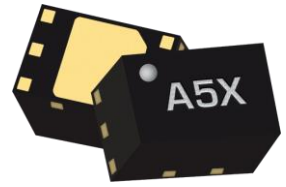

1.2 Features

- +21 dBm output power
- +18 dB gain
- 1.2 dB noise figure
- Excellent Gain flatness
- Excellent Return Losses
- No negative bias required
- .s2p S-Parameters: [ADM-8095PSM](#)

1.3 Applications

- Mobile test and measurement equipment
- Radar and satellite communications
- 5G Transceivers
- Driver amplifier H & S – diode mixers

1.4 Functional Block Diagram

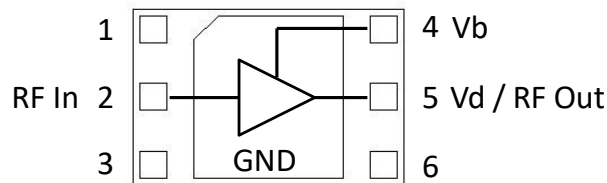

1.5 Part Ordering Options¹

Part Number	Description	Package	Green Status	Product Lifecycle	Export Classification
ADM-8095PSM	1.3 x 2 mm Surface Mount	DFN	RoHS	Active	EAR99
EVB-ADM-8095P	Connectorized Evaluation Fixture	EVAL	RoHS	Active	EAR99

¹ Refer to our [website](#) for a list of definitions for terminology presented in this table.

Table of Contents

1. Device Overview	1	3.2 Package Information	4
1.1 General Description	1	3.3 Recommended Operating Condition...	5
1.2 Features	1	3.4 Supply Sequencing Requirements	5
1.3 Applications	1	3.5 Electrical Specifications	6
1.4 Functional Block Diagram	1	3.6 ADM-8095PSM Typical Performance Plots.....	7
1.5 Part Ordering Options.....	1	4. Application Information	9
2. ADM-8095 Port Configurations and Functions	3	4.1 Application Circuit	9
2.1 ADM-8095PSM Port Diagram.....	3	5. Mechanical Data	10
2.2 ADM-8095PSM Port Functions	3	5.1 ADM-8095PSM Package Outline Drawing	10
3. Specifications	4	5.2 ADM-8095PSM Recommended Landing Pattern	11
3.1 Absolute Maximum Ratings.....	4	5.3 EVB-ADM-8095P Outline Drawing .	11
		5.4 EVB-ADM-8095P Bill of Materials .	12

Revision History

Revision Code	Revision Date	Comment
-	September 2022	Initial Release

2. ADM-8095 Port Configurations and Functions

2.1 ADM-8095PSM Port Diagram

A port diagram of the ADM-8095PSM DFN package is shown below (X-ray view from the top). The pin functions are detailed in section 2.2 of this datasheet.

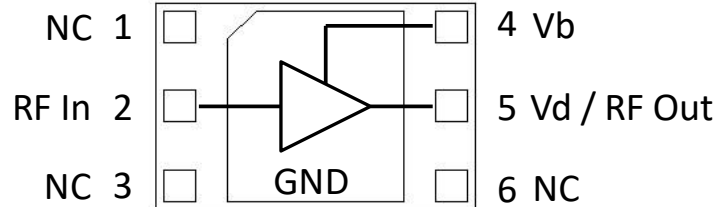

2.2 ADM-8095PSM Port Functions

Pin	Function	Description
2	RF Input	Pin 2 is the RF Input port of the amplifier. It is internally RF matched to 50 Ω and requires an external DC blocking cap.
5	RF Out / Vd	Pin 5 is the RF Output port and is also the Vd port providing the main power supply to the amplifier. This pin is DC coupled and requires an external bias-T or discrete choke and DC blocking capacitor. This port is RF matched to 50 Ω . DC voltage at this pin should be set to 5V for normal operation.
4	Vb	Pin 4 provides DC bias to the amplifier. Placement of an external series bias resistor allows this pin to be supplied by the same supply line providing 5V to Pin 5. For normal operation at 5V Vd, the recommended series bias resistor value is 3.3k Ω . Device drain current will change proportional to the current flowing into this pin. RF performance can be balanced with DC power consumption by adjusting this current.
1,3,6	Gnd	These pins should be connected to ground.
Paddle	Gnd	Package ground paddle must be connected to a DC/RF ground potential with high thermal and electrical conductivity.

3. Specifications

3.1 Absolute Maximum Ratings

The Absolute Maximum Ratings indicate limits beyond which damage may occur to the device. If any one of these limits are exceeded, the device may become inoperable or have a reduced lifetime.

Reliability limits are individual, instantaneous catastrophic limits only. Functional operation limits are indicated below. Operation of the device at multiple absolute maximum limits or for extended periods at a single limit can cause degradation and damage to the device.

Parameter	Maximum Rating	Units
Drain Supply Voltage (Vd)	+8	V
Drain Current (RF Applied)	90	mA
Bias Voltage (Vb)	+8	V
RF Input Power	+15	dBm
Operating Temperature for MTTF > 1E6 hours	-40 to +85	°C
Storage Temperature	-65 to +125	°C
θ_{Jc} , Junction to Case Thermal Resistance	76	°C/W
Max Junction Temperature for MTTF of 1E6 hours	175	°C
Max Power Dissipation for MTTF of 1E6 hours	0.26	W

3.2 Package Information

Parameter	Details	Rating
Weight	ADM-8095PSM	7 mg

3.3 Recommended Operating Condition

The Recommended Operating Conditions indicate the limits, inside which the device should be operated, to guarantee the performance given in Electrical Specifications. Operating outside these limits may not necessarily cause damage to the device, but the performance may degrade outside the limits of the electrical specifications. For limits, above which damage may occur, see Absolute Maximum Ratings.

Recommended Operating Conditions	Min	Nominal	Max	Units
T _A , Ambient Temperature	-40	+25	+85	°C
Power Supply DC Voltage (V _d)	+3	+5	+6	V
Power Supply DC Current (I _d) (No RF Input) ²	21	39	47	mA
Input Power for Saturation	+2	+4	+6	dBm

3.4 Supply Sequencing Requirements

There is no sequencing required to power up or power down the amplifier. The amplifier must have an output load connected during operation.

² Recommended operating current conditions without RF input applied.

3.5 Electrical Specifications

Unless otherwise specified, electrical specifications apply at $T_A=+25^{\circ}\text{C}$, $V_d = 5\text{ V}$, $V_b = 5\text{ V}$.

Parameter	Test Conditions	Frequency	Min	Typical	Units	
Saturated Output Power	$V_d, V_b = 5\text{ V}$	0.09 – 10 GHz		+21	dBm	
Small Signal Gain	$V_d, V_b = 5\text{ V}$, $P_{in} = -20\text{ dBm}$			18		
Input Return Loss				17		
Output Return Loss				21		
Reverse Isolation				23		
Noise Figure				0.2 – 5 GHz		1.2
			5 – 10 GHz	1.5		
Input IP3	$V_d, V_b = 5\text{ V}$, $P_{in} = -15\text{ dBm}$ per tone, 10 MHz tone spacing	0.09 – 10 GHz		+14	dBm	
Output IP3				+30		
Output IP2			0.09 – 6 GHz			+33
			6 – 10 GHz			+30
Output P1dB	$V_d, V_b = 5\text{ V}$	0.09 – 10 GHz		+18		
Input Power for Saturation				+4		
DC Supply Quiescent Current (I_{dq})	$V_d, V_b = 5\text{ V}$, no RF input			39	mA	

3.6 ADM-8095PSM Typical Performance Plots^{3,4}

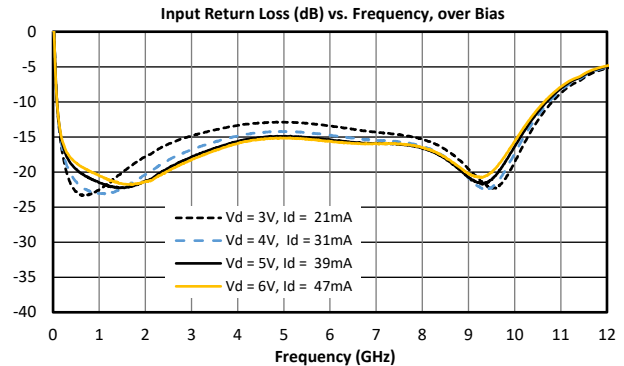
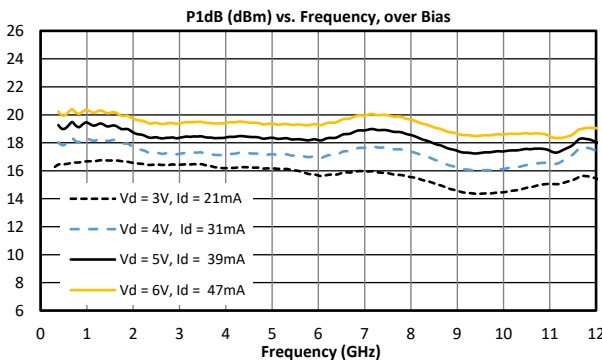
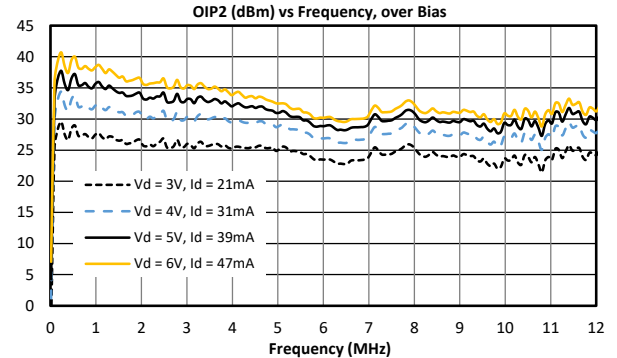
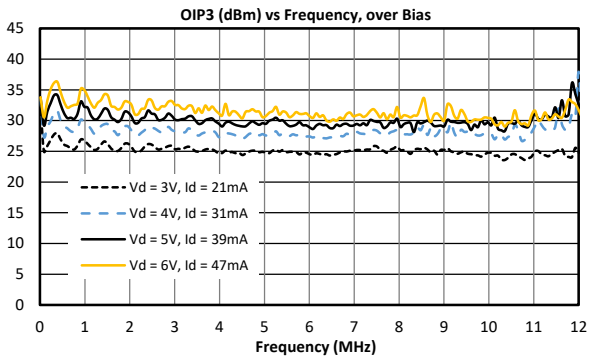
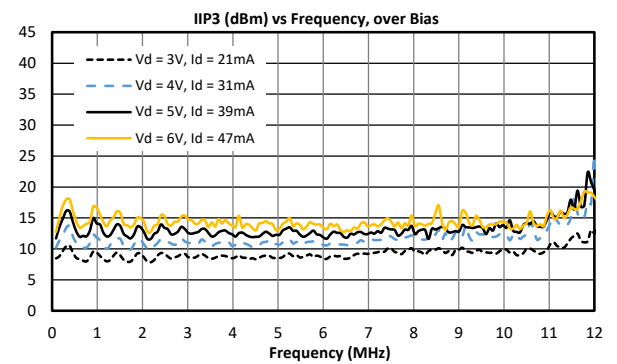
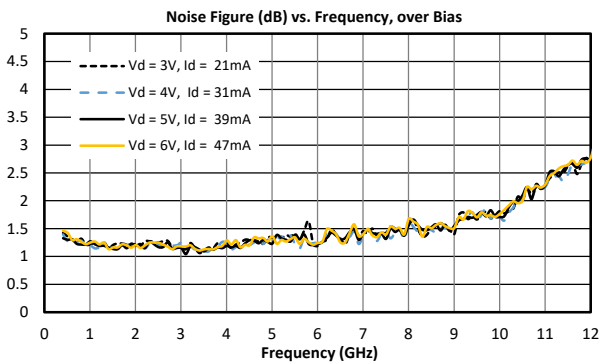
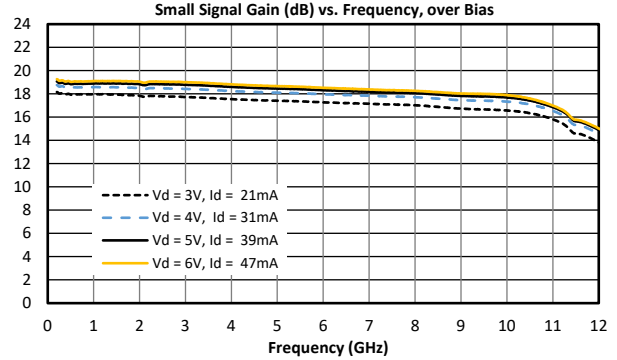
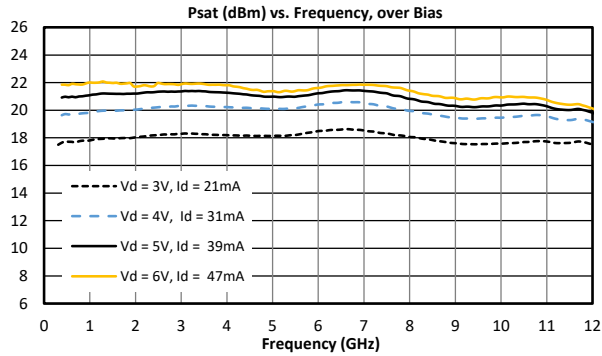

³ Performance measured on EVB-ADM-8095P with R₂ = 3.3k Ohms.

⁴ P_{sat}, Small Signal Gain and Noise Figure plots have PCB trace loss de-embedded.

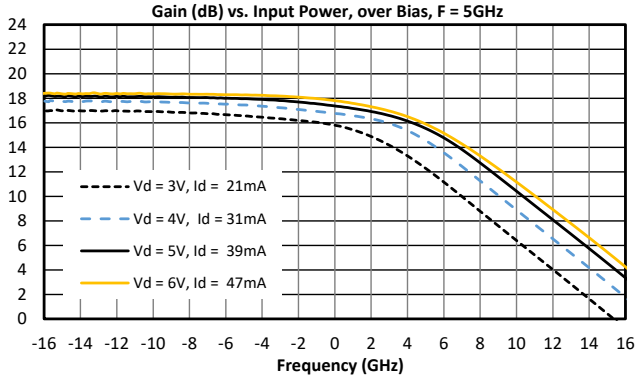
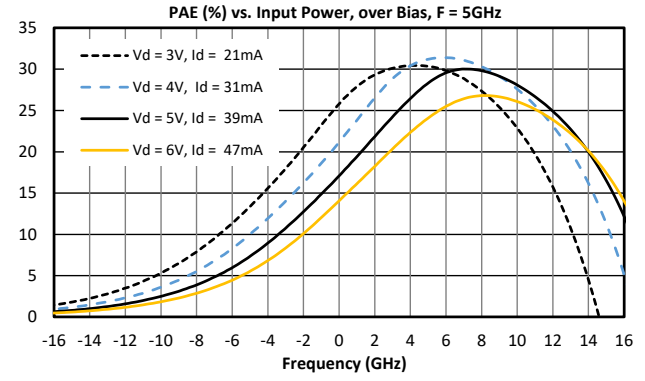
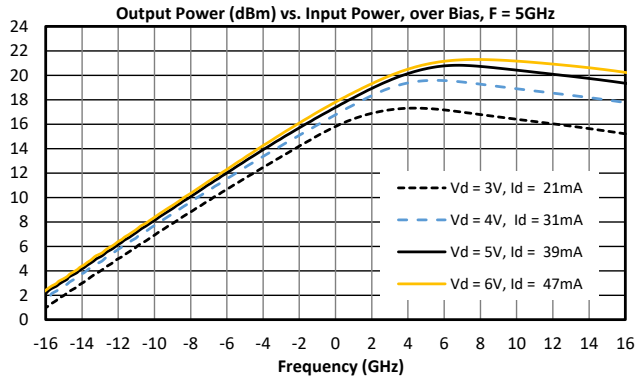
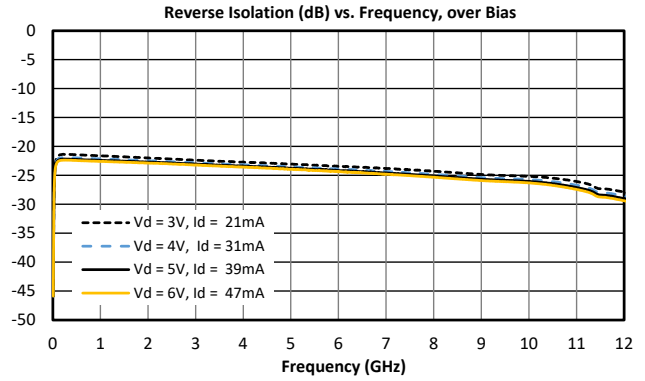
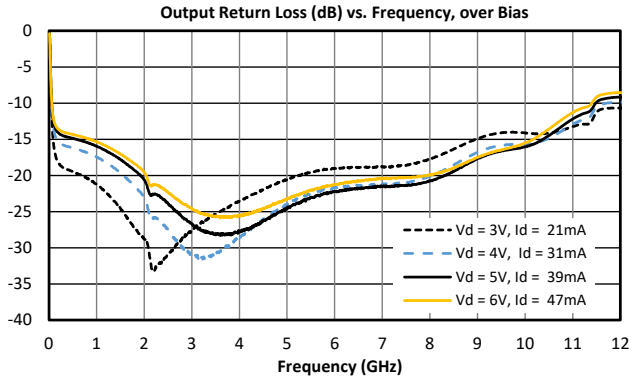

4. Application Information

4.1 Application Circuit

Below is the recommended application circuit for the ADM-8095PSM. DC power is supplied to RF Out/Vd pin 5 via a 150 nH choke inductor. Supply bypassing is provided by 100pF and 0.1uF capacitors. Drain current I_d can be controlled by applying voltage to Vb pin 4. Drain current I_d is adjusted proportionally to the current flowing into pin 4 with higher Vb and Ib resulting in increased current I_d . Amplifier performance can therefore be optimized for specific applications by adjusting the value of series resistor R2 on the Vb line. In particular, OIP3 across the band and especially at low voltage Vd can be improved from that shown in section 3.6 by increasing current into pin 4. The OIP3 can be improved by up to 4dB with the tradeoff being increased quiescent DC power consumption. EVB-ADM-8095P has provisions for an 0201 SMD resistor to be placed in series on the Vb line. The default value for R2 is 3.3k Ohms. For higher OIP3, R2 should be reduced to 453 Ohms. The ADM-8095PSM requires an RF input matching network at RF In pin 2 as shown. DC blocking capacitors are also required at RF input and output pins as shown. Note that EVB-ADM-8095P does not include DC blocking capacitors and must be externally blocked. See section 5.4 for more details on the EVB circuit layout and component values. Contact support@markimicrowave.com if you would like help creating an alternative application circuit for your system's requirements.

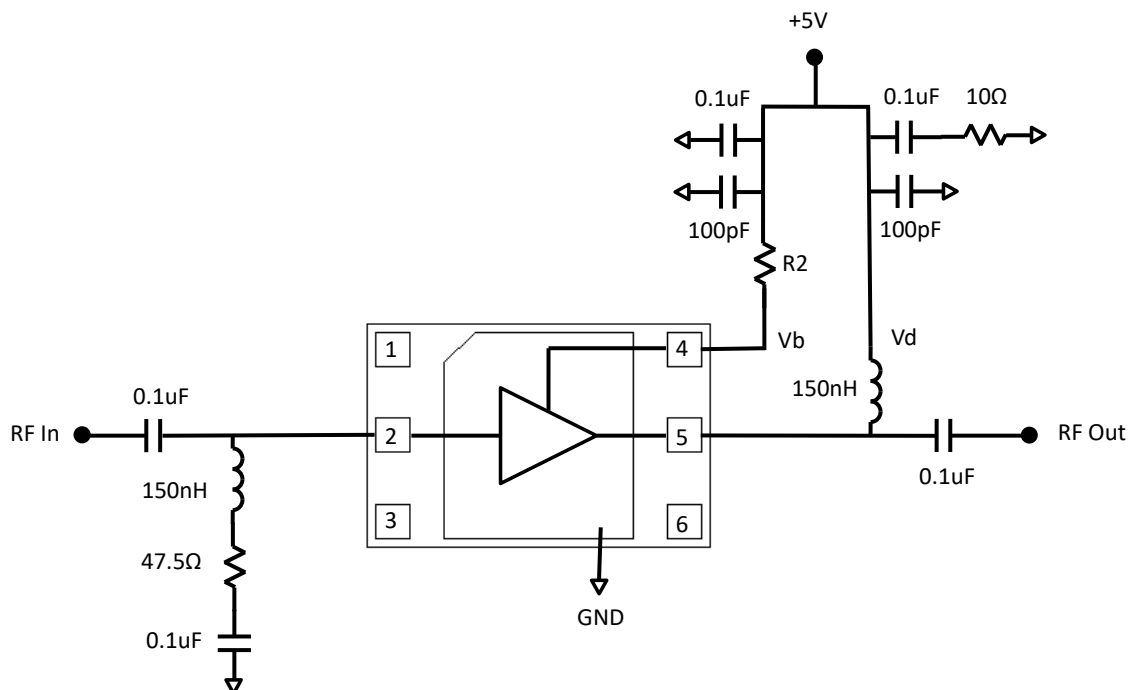

5. Mechanical Data

5.1 ADM-8095PSM Package Outline Drawing

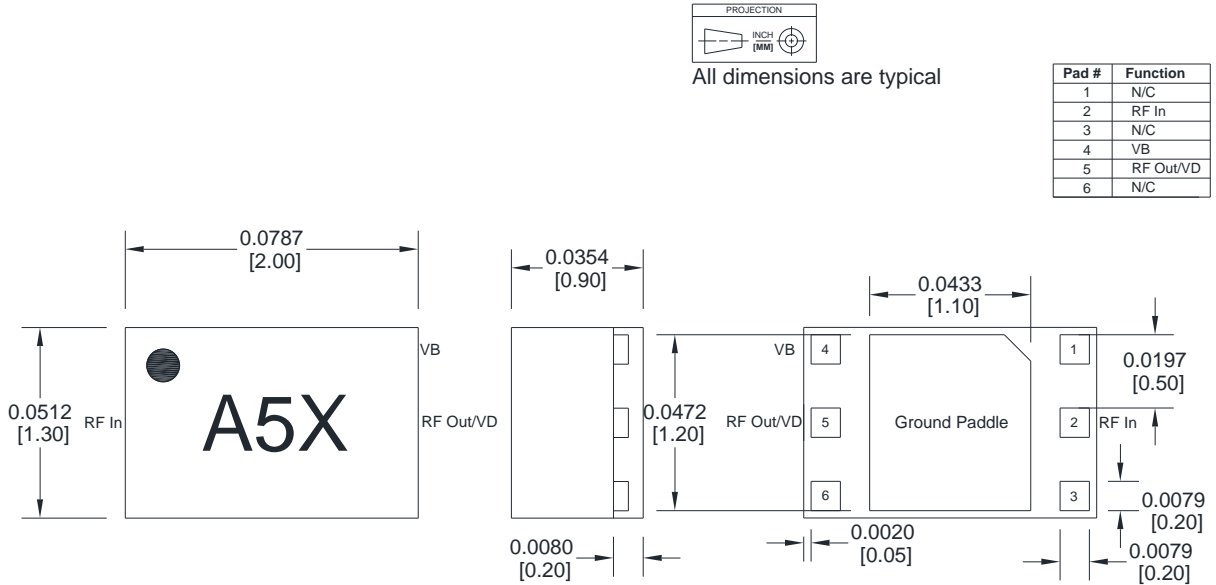

- 1) Substrate material is LCP
- 2) I/O Leads and Die Paddle is (from base to finish):
 - a. Ni: 0.5 um MIN
 - b. Pd: 0.02 um MIN
 - c. Au: 0.05 um MAX
- 3) All unconnected pins should be attached to PCB RF ground.

5.2 ADM-8095PSM Recommended Landing Pattern

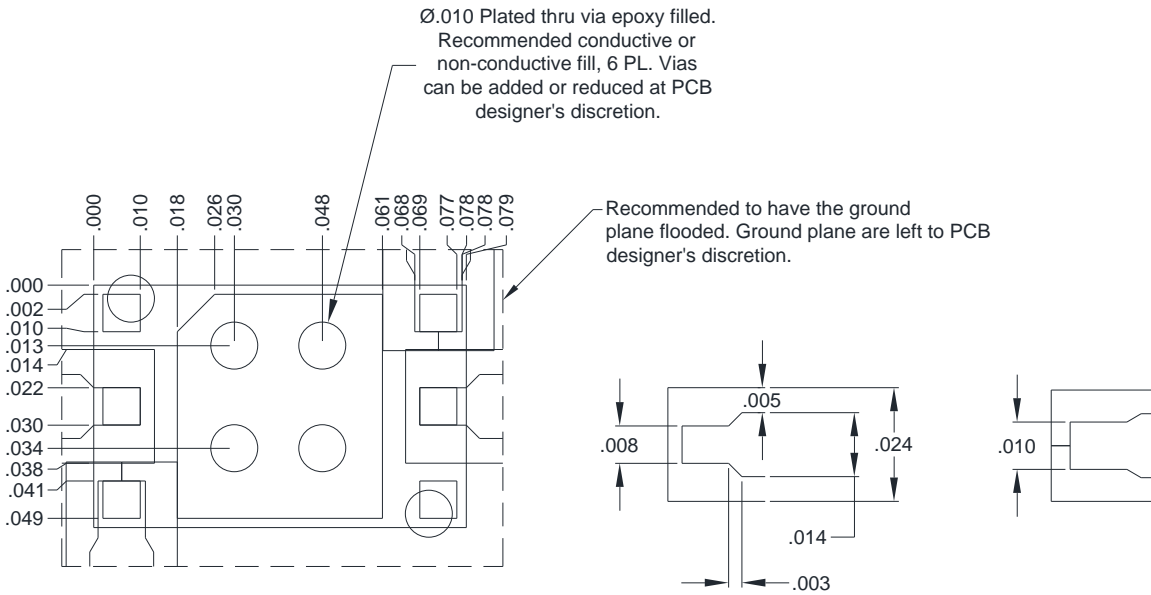

The landing pattern is to be used on Rogers 4003, 0.008" thick, $\frac{1}{2}$ Oz Cu.

5.3 EVB-ADM-8095P Outline Drawing

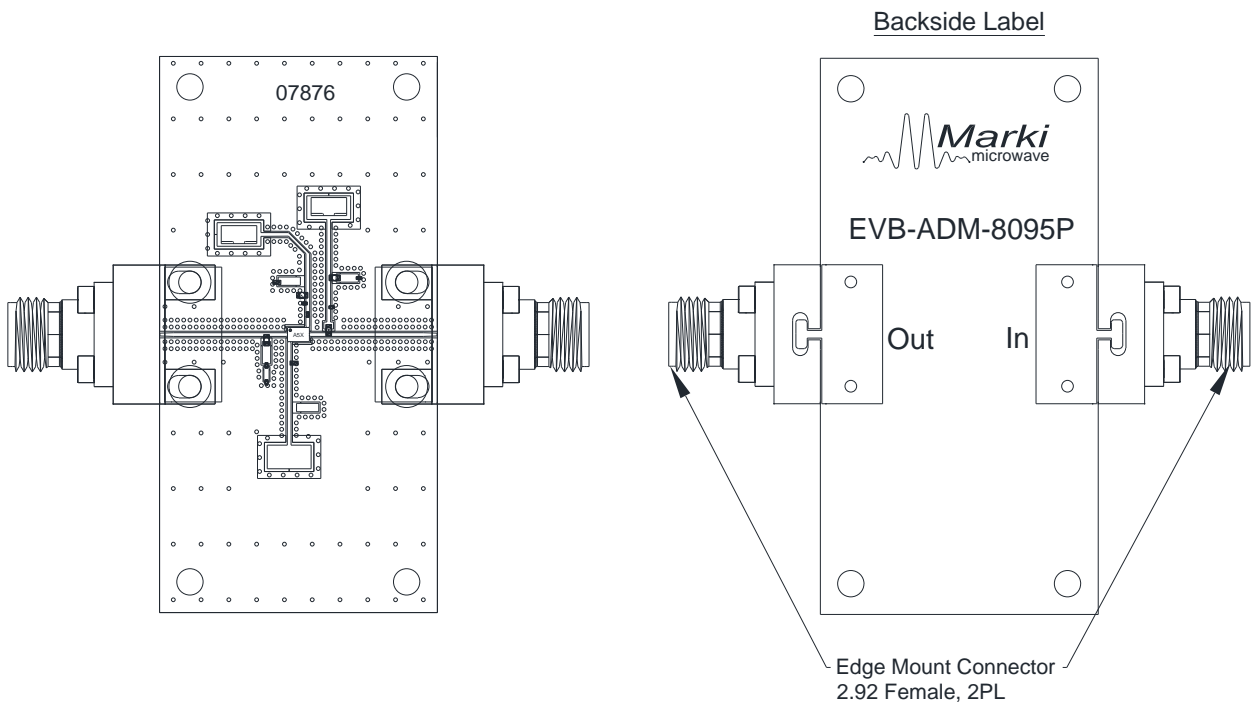

5.4 EVB-ADM-8095P Bill of Materials

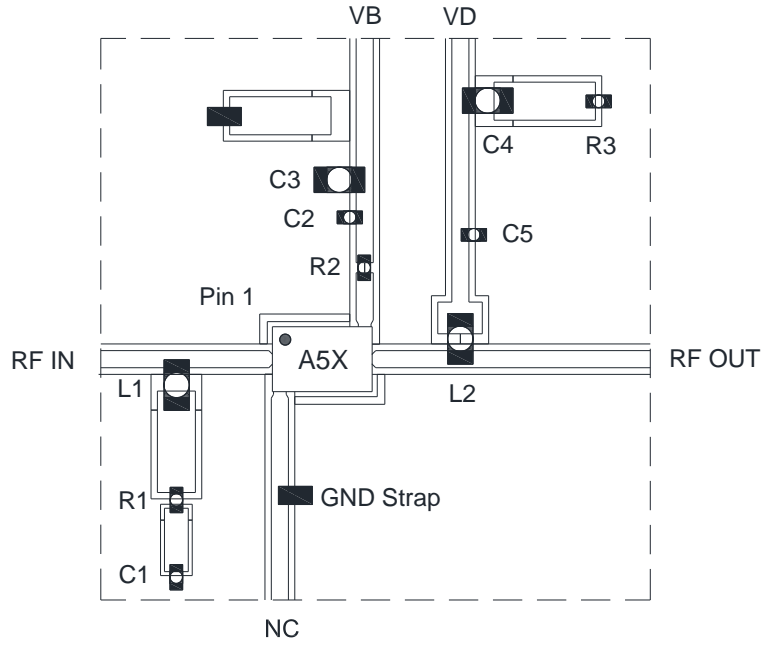

Reference	Manufacturer	Description	Qty
In, Out	Southwest	Connector, Edge Mount, 2.9mm F	2
C1	Murata	0201 Cap Cer 0.1 μ F 10V X5R	1
C3, C4	Murata	0402 Cap Cer 0.1uF	2
C2, C5	Murata	0201 Cap Cer 100pf	2
R1	Panasonic	0201 Res 47.5 Ω 5% 1/20W	1
R2	Panasonic	0201 Res 3.3k Ω 5% 1/20W	1
R3	Panasonic	0201 Res 10 Ω 5% 1/20W	1
L1, L2	Coilcraft	0402 Ind 150nH (MFR PN: 0402HPH-R15X_R)	2
U1	Marki	0.09-10GHz, 19 dBm Amplifier (ADM-8095PSM)	1