

BROADBAND DISTRIBUTED AMPLIFIER

ADM-0126-5835SM

The ADM-0126-5835SM is a broadband, efficient GaAs PHEMT distributed amplifier with an integrated bias tee in a 4mm QFN surface mount package, designed to provide efficient LO drive for T3 mixers. It offers 11 dB typical gain and 15 dBm typical output power at 1 dB compression for only 80 mA of current. The ADM-0126-5835SM is operated with a 5-7 volt positive bias and an optional current reducing negative voltage. Applications include amplification of LO drive signals for 'L', 'M', 'I', and 'H' level mixers, clock signals, and other general purpose driver applications in electronic warfare and test and measurement. The ADM-0126-5835SM is an excellent alternative to competing GaAs PHEMT distributed amplifiers.

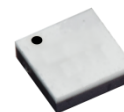

Features

- Optimized for use as a [T3 LO buffer amplifier](#)
- Suitable for driving L, M, I and H diode mixers
- Optional Positive Bias Operation
- Integrated Blocking Capacitors and Inductors
- 3rd and 5th Harmonic Generation
- Broadband 50 Ω Matching
- Unconditionally Stable

Electrical Specifications - Specifications guaranteed from -55 to +85°C, measured in a 50-Ohm system.

Parameter	Frequency (GHz)	Min	Typ	Max	
Input for Saturated Output (dBm)	0.7-26.5	+5	+10	+12	
Output 1 dB Compression (dBm)			+15		
Saturated Output Power with negative bias (dBm)				+17	
Small Signal Gain with negative bias (dB)				11	
Input Return Loss (dB)				12	
Output Return Loss (dB)				14	
Noise Figure (dB)				4	
Third Order Output Intercept Point (dBm)				25	
Bias Requirements (mA)					
Vd: +5.0 to +7.0 / Vg: -0.25 Volts				80	
Vd: +6.0 to +7.0 / Vg: 0 Volts			90		

Part Number Options

Model Number	Description
ADM-0126-5835SM ¹	Surface Mount 4mm QFN
EVAL-ADM-5835SM	Connectorized Evaluation Fixture

¹ Note: For port locations and I/O designations, refer to the drawings on pages 2, 8, and 9 of this document.

GaAs MMIC devices are susceptible to Electrostatic Discharge. Use proper ESD precautions when handling these items.

BROADBAND DISTRIBUTED AMPLIFIER

ADM-0126-5835SM

Page 2

Frequency 0.7 to 26.5 GHz

Functional Diagram and Application Circuit

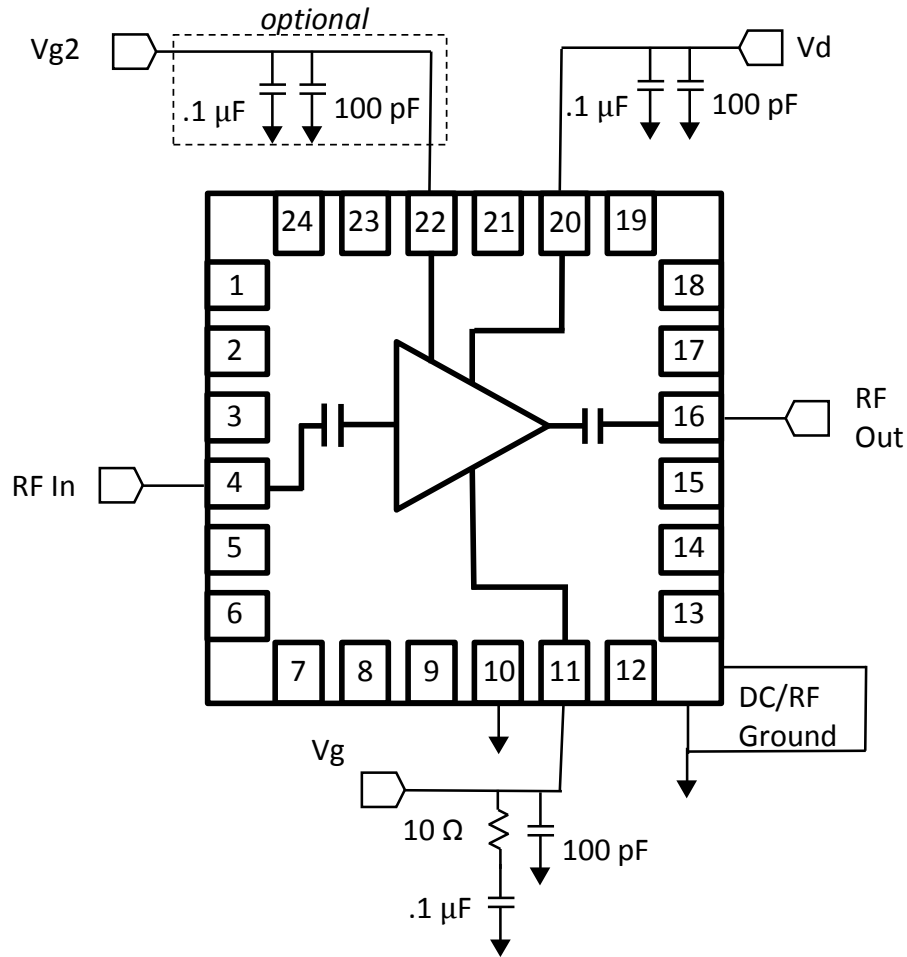

Biasing and Operation

RF In / RF Out – Input and output signals should be connected by 50 ohm microstrip or coplanar traces to well matched 50 ohm sources and loads. No external bias capacitor or inductor is required.

Vg /Vg2 – Bias on these pins is optional. Biasing of -0.2 V on Vg can reduce the current draw. It is recommended that the user supply a broadband, low impedance signal path to ground on this pin by providing multiple capacitance values with different resonant points to ground. It is also recommended to supply a 10 Ω resistor in series with any bypass capacitor with a value above 1 nF for Vg to eliminate self-resonant points in the circuit.

Vd- Bias supply on Vd should be voltage limited below 9 V and current limited below 200 mA at all times. The operational bias voltage should be between 5 V and 8 V for full gain, efficiency, and linearity. In general gain, linearity, and output power will increase marginally with increased voltage from 5 to 8 V. As with Vg/Vg2, it is recommended that the user supply a broadband, low impedance signal path to ground on this pin by providing multiple capacitance values with different resonant points to ground.

DC/RF Ground – The ground paddle of the QFN should be connected to a low noise RF and DC ground with very low electrical and thermal resistance for high frequency operation and thermal heat sinking.

BROADBAND DISTRIBUTED AMPLIFIER

ADM-0126-5835SM

Typical Performance: Positive Only (+6 to +7V) Bias (Pin 20), Grounded Gate (Pin 11)

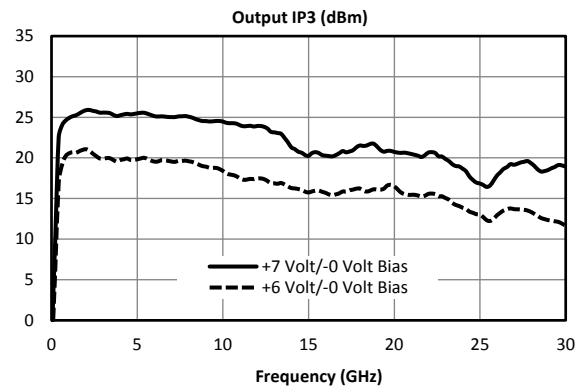
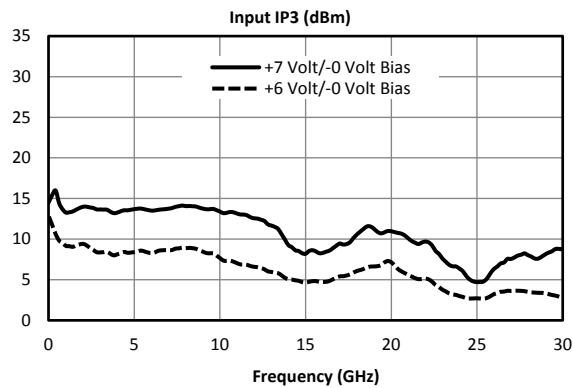
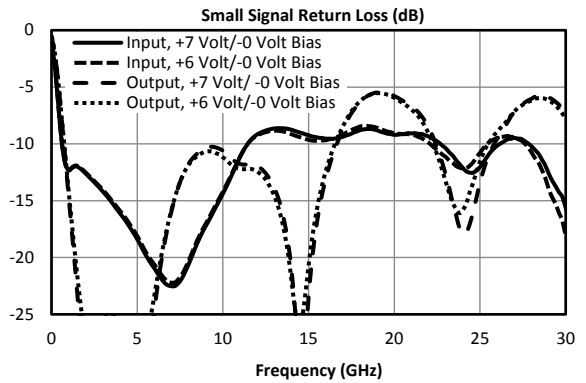
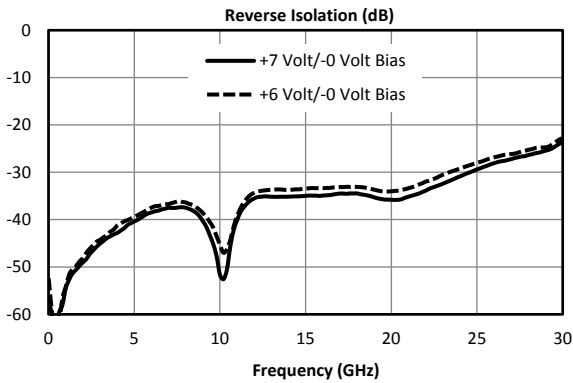
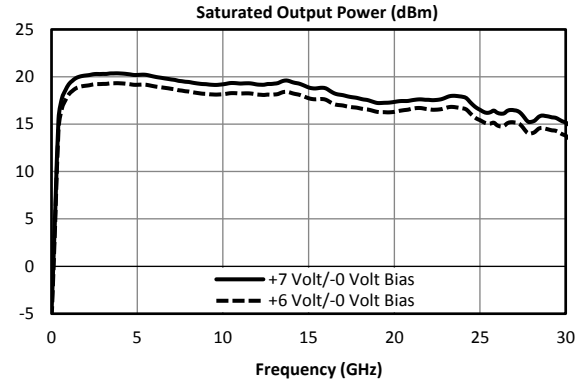
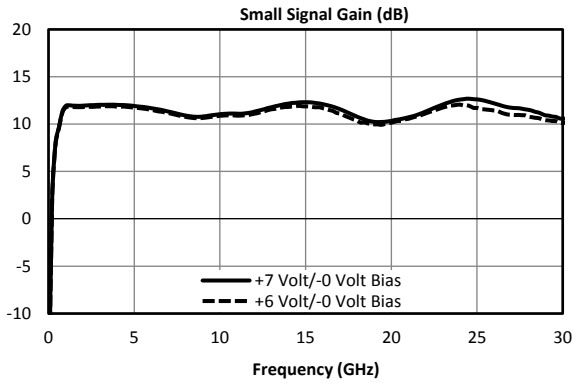

BROADBAND DISTRIBUTED AMPLIFIER

ADM-0126-5835SM

Page 4

Frequency 0.7 to 26.5 GHz

Typical Performance: Positive Only (+6 to +7V) Bias (Pin 20), Grounded Gate (Pin11), continued

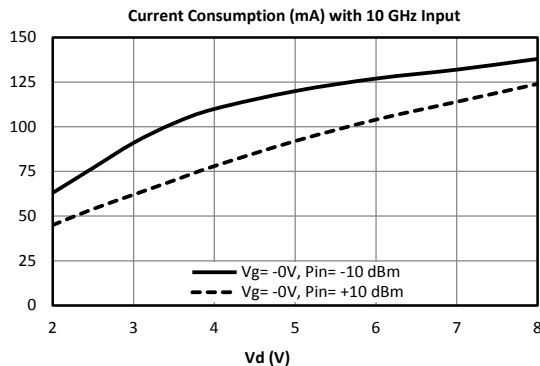
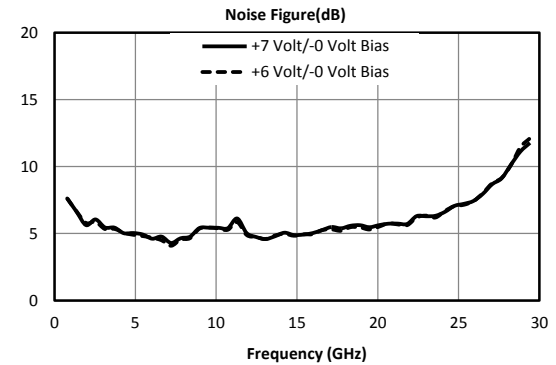
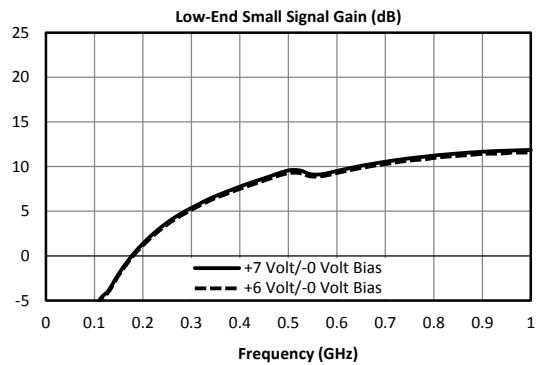
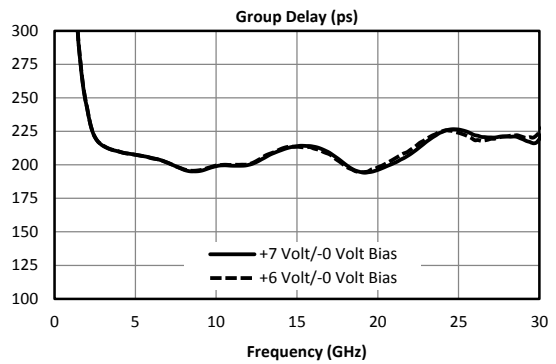
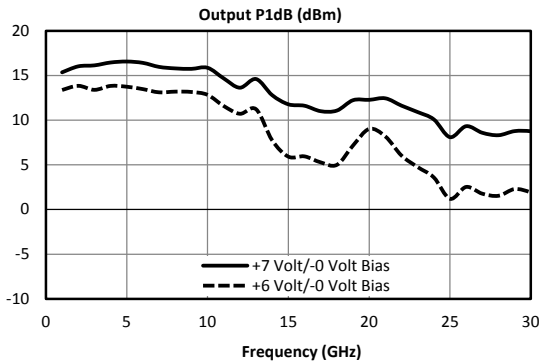
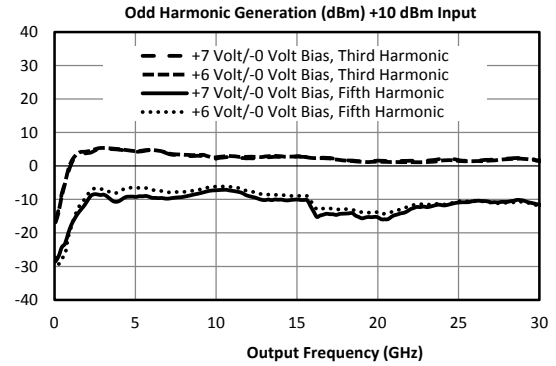
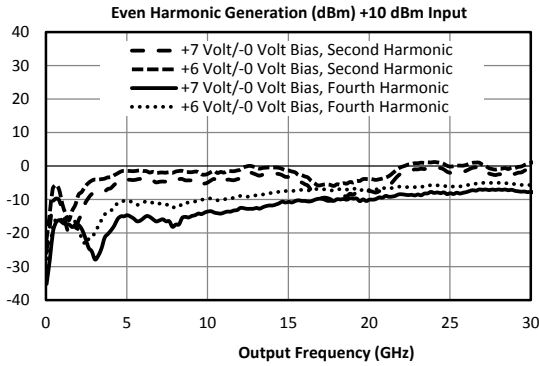

BROADBAND DISTRIBUTED AMPLIFIER

ADM-0126-5835SM

Page 5

Frequency 0.7 to 26.5 GHz

Typical Performance: +4 to +7V Bias (Pin 20), -0.25 Negative Bias (Pin11)

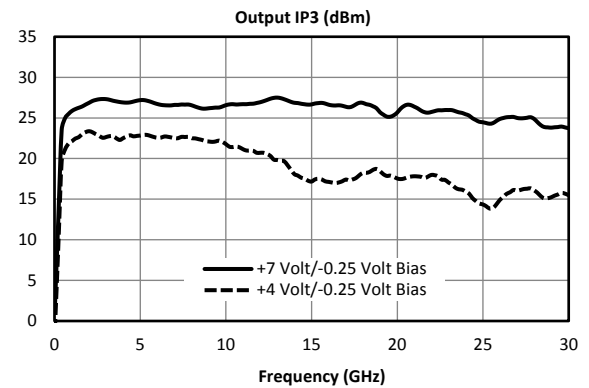
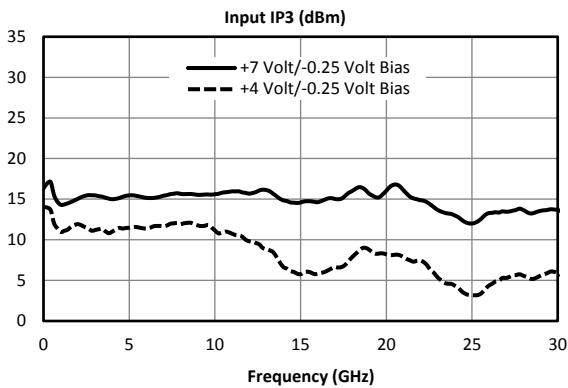
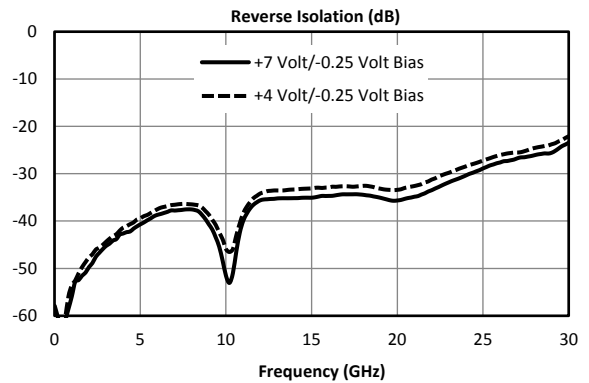
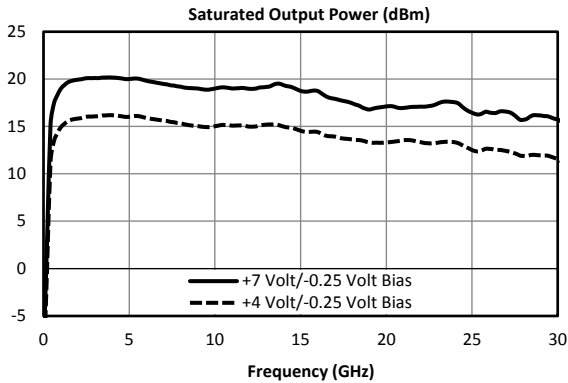
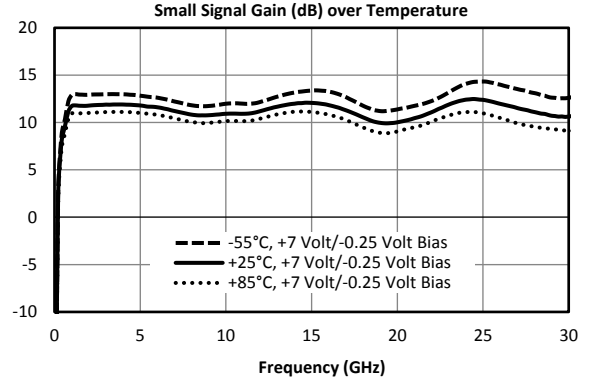
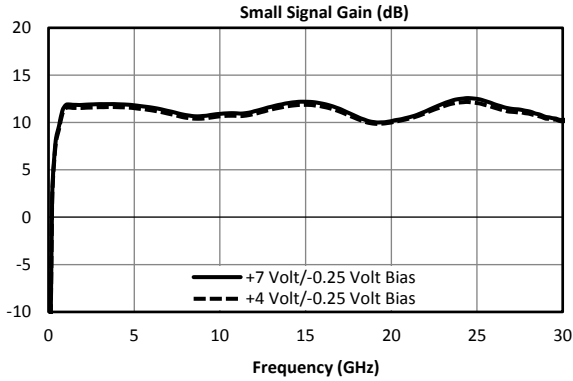

BROADBAND DISTRIBUTED AMPLIFIER

ADM-0126-5835SM

Page 6

Frequency 0.7 to 26.5 GHz

Typical Performance: +4 to +7V Bias (Pin 20), -0.25 Negative Bias (Pin11), continued

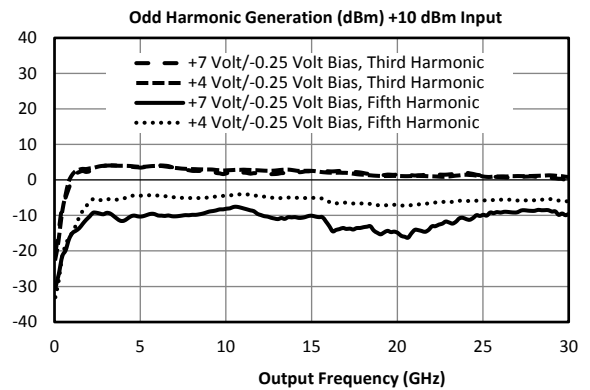
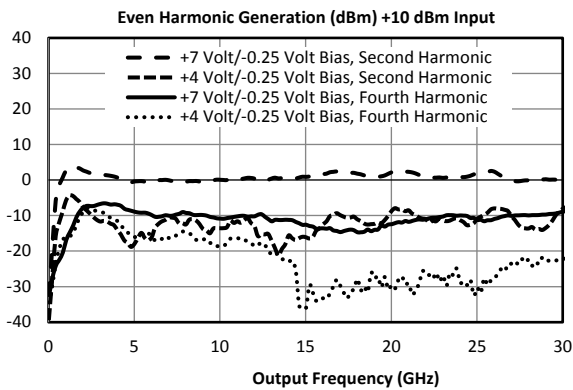
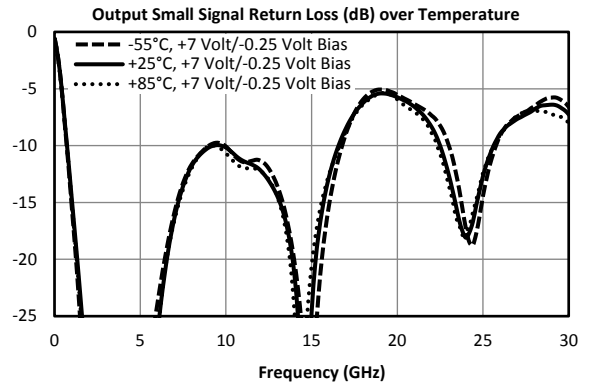
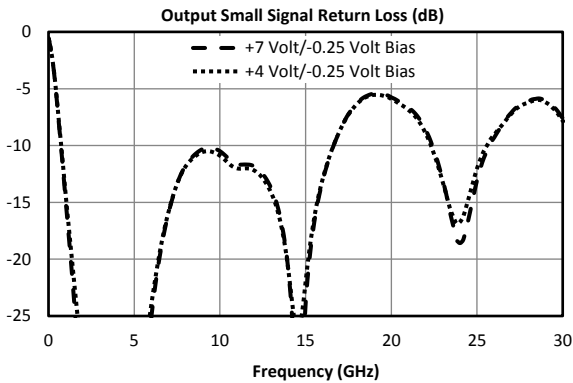
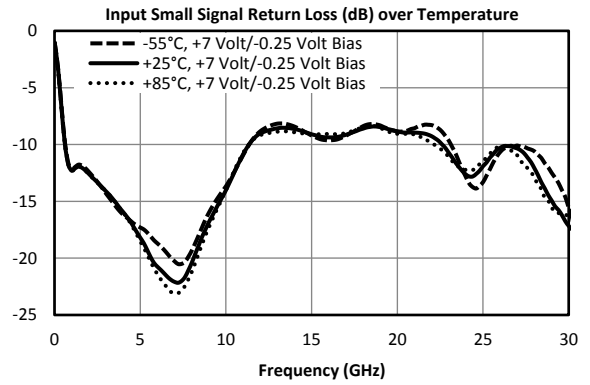
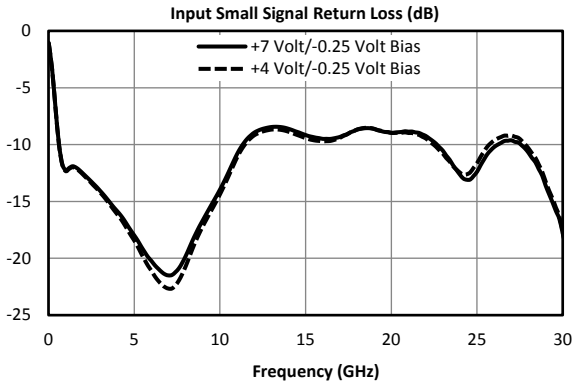

BROADBAND DISTRIBUTED AMPLIFIER

Page 7

ADM-0126-5835SM

Frequency 0.7 to 26.5 GHz

Typical Performance: +4 to +7V Bias (Pin 20), -0.25 Negative Bias (Pin11), continued

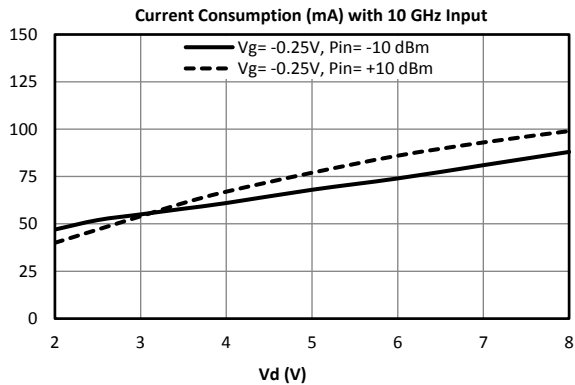
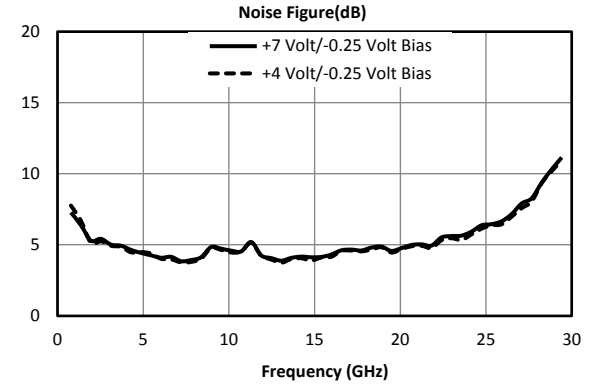
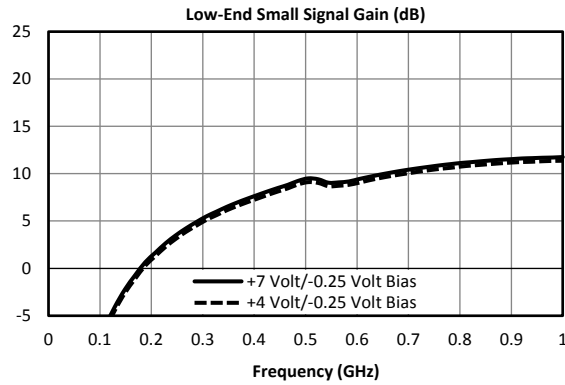
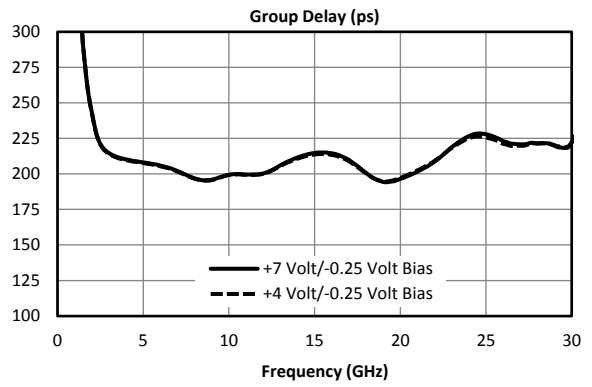
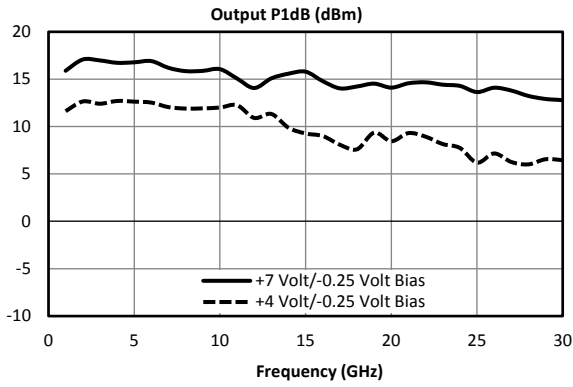

BROADBAND DISTRIBUTED AMPLIFIER

ADM-0126-5835SM

Outline Drawing

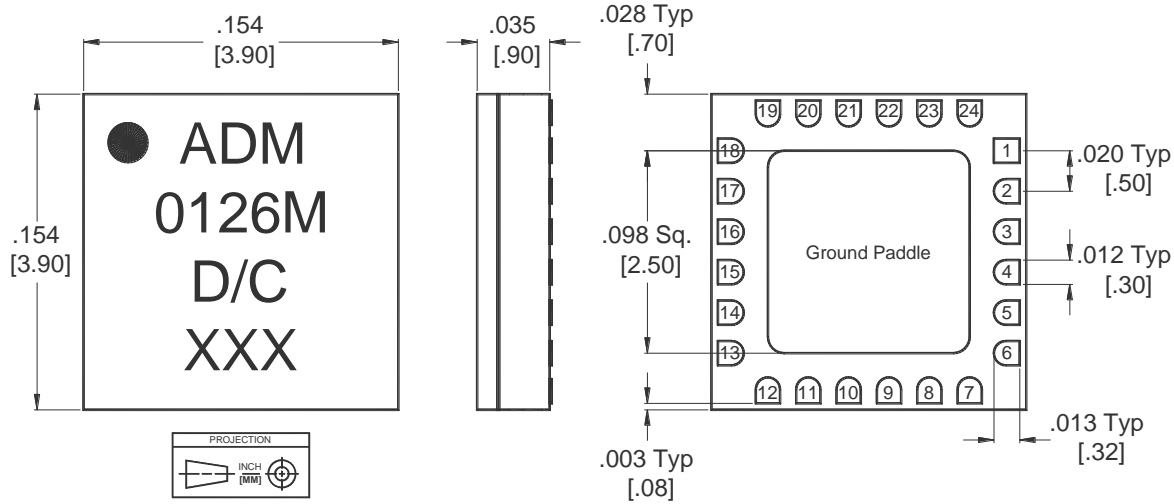

Pad #	Function
1	N/C
2	N/C
3	N/C
4	RF In
5	N/C
6	N/C
7	N/C
8	N/C
9	N/C
10	GND
11	Vg
12	N/C
13	N/C
14	N/C
15	N/C
16	RF Out
17	N/C
18	N/C
19	N/C
20	Vd
21	N/C
22	Vg2
23	N/C
24	N/C

Substrate material is Ceramic.

I/O Leads and Ground Paddle are 1.4±0.6 microns Au over 1.3 microns Ni.

All unconnected pads should be connected to PCB RF ground.

PCB Footprint Drawing

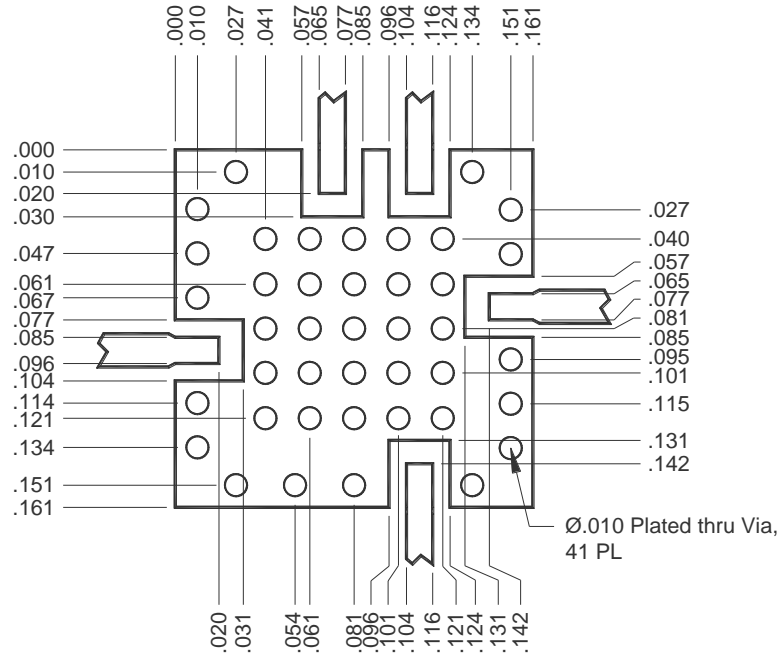

QFN-Package Surface-Mount Landing Pattern





[Click here for a DXF of the above layout.](#)

[Click here for leaded solder reflow.](#) [Click here for lead-free solder reflow.](#)

BROADBAND DISTRIBUTED AMPLIFIER

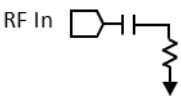
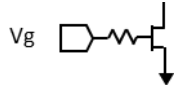
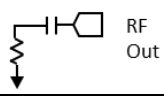
ADM-0126-5835SM

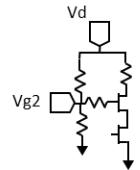
Frequency 0.7 to 26.5 GHz

Pin Descriptions			
Pin Number	Function	Description	Interface Schematic
1-3,5-9,12-15,17-19,21,23,24	NC	These pins are not connected internally. Datasheet performance is tested with NC pins grounded.	
4	RF in	This pin is AC coupled and matched to 50 Ω.	
11	Vg	Gate control for the amplifier. Adjust to achieve I _{dd} = 85 mA (should be near -0.2V). External bypass capacitors and Q reduction resistor are recommended.	
16	RF out	This pad is AC coupled and matched to 50 Ω.	
20	Vd	Power supply voltage for the amplifier. External bypass capacitors are required.	
22	Vg2	Optional gate control if AGC is required. Leave Vg2 open circuited if AGC is not required. Typical Vg2 = -2V to 2.4V	
10, Paddle	GND	Ground pad should be connected to RF/DC ground with low electrical and thermal resistance.	

Absolute Maximum Ratings	
Parameter	Maximum Rating
Positive Bias Voltage	9 V
Positive Bias Current	200 mA
Negative Bias Voltage	-2 V
Negative Bias Current	2 mA
RF Input Power	+15 dBm
Power Dissipation	875 mW
Thermal Resistance, θ _{jc}	1.177 (C/W)
ESD (Human Body Model)	Class 0
Operating Temperature	-55°C to +85°C
Storage Temperature	-65°C to +150°C

BROADBAND DISTRIBUTED AMPLIFIER

ADM-0126-5835SM

Page 10

Frequency 0.7 to 26.5 GHz

Evaluation Board

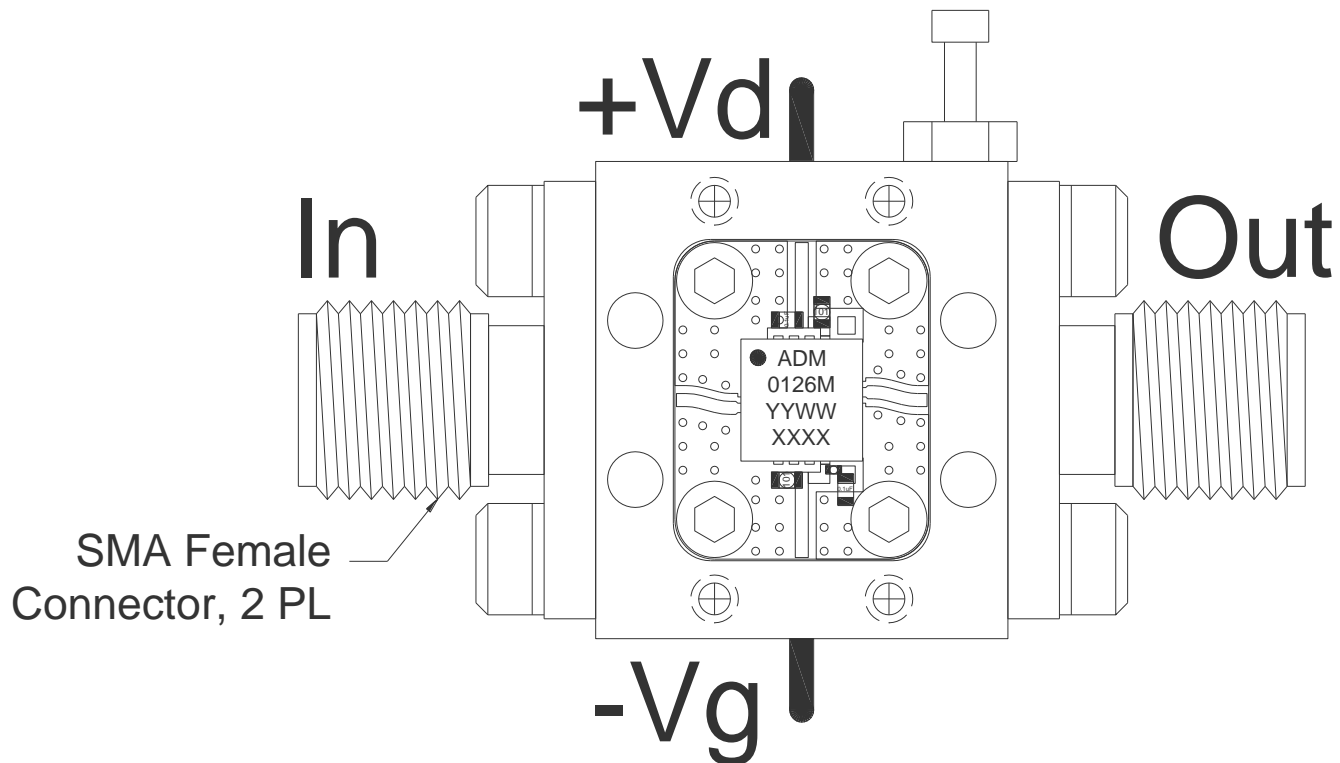

The evaluation module follows Marki standard assembly and evaluation procedures to give optimal performance for datasheet characterization. Actual performance will depend on substrate material, bypass capacitors, resistors, connectors, quality of bias current/voltage source, and assembly process.

Evaluation Board Bill of Materials	
Item	Description/Part Number
Connectors	Southwest 214-510SF
Bias Pins	Kovar
Housing	Aluminum
Circuit	.008 Thick Rogers 4003
0.1 uF Capacitor	AVX 0402YD104KAT2A
10 Ω Resistor	Venkel CR0201-20W-100JT
100 pF Capacitor	KEMET C0402C101K4GACTU
A26LGP	ADM-0126-5835SM

DATA SHEET NOTES:

1. Specifications are subject to change without notice. Contact Marki Microwave for the most recent specifications and data sheets.

Marki Microwave reserves the right to make changes to the product(s) or information contained herein without notice. Marki Microwave makes no warranty, representation or guarantee regarding the suitability of its products for any particular purpose, nor does Marki Microwave assume any liability whatsoever arising out of the use of or application of any product.