

GaAs MMIC High Dynamic Range Mixer

MM1-1467L

1. Device Overview

1.1 General Description

MM1-1467L is a GaAs MMIC double balanced mixer with a broad IF bandwidth and low conversion loss. This mixer ideal for applications which require broad IF bandwidths with operation at mmWave frequencies. The MM1-1467L is available as both wire bondable die and as connectorized modules. The -1 option for die is available for this mixer. Both the -1 and -2 mixers are electrically identically but with mirrored footprints.



Die



Module

1.2 Features

- High LO to RF isolation
- Broad IF bands covering critical Ku & K band
- Flat IF response through K band
- Low LO drive

1.3 Applications

- Test and measurement equipment
- Fixed RF up converters
- Electronic warfare equipment

1.4 Functional Block Diagram

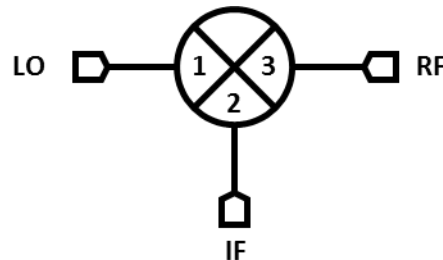

1.5 Part Ordering Options¹

Part Number	Description	Package	Green Status	Product Lifecycle	Export Classification
MM1-1467LCH-2	Wire bondable die	CH (option -2)	RoHS	Active	EAR99
MM1-1467LCH-1	Wire bondable die	CH (option -1)		Active	EAR99
MM1-1467LUB	Connectorized module	UB		Active	EAR99

¹ Refer to our [website](#) for a list of definitions for terminology presented in this table.

Table of Contents

1. Device Overview	1	3.6.2 Typical Performance Plots: LO Harmonic Isolation.....	9
1.1 General Description.....	1	3.6.3 Typical Performance Plots: Tuner Mixer.....	10
1.2 Features	1	3.6.4 Typical Spurious Performance: Down-Conversion	11
1.3 Applications	1	3.6.5 Typical Spurious Performance: Up-Conversion	11
1.4 Functional Block Diagram	1	4. Die Mounting Recommendations	12
1.5 Part Ordering Options.....	1	4.1 Mounting and Bonding Recommendations	12
2. Port Configurations and Functions	3	4.2 Handling Precautions	12
2.1 Port Diagram.....	3	4.3 Bonding Diagram	13
2.2 Port Functions	3	5. Mechanical Data.....	14
3. Specifications	4	5.1 CH Package Outline Drawing (Option - 2).....	14
3.1 Absolute Maximum Ratings.....	4	5.2 CH Package Outline Drawing (Option - 1).....	14
3.2 Package Information	4	5.3 UB Package Outline Drawing	15
3.3 Recommended Operating Conditions .	4		
3.4 Sequencing Requirements	4		
3.5 Electrical Specifications	5		
3.6 Typical Performance Plots	6		
3.6.1 Typical Performance Plots: IP3 ..	8		

Revision History

Revision Code	Revision Date	Comment
-	May 2019	Datasheet Initial Release

2. Port Configurations and Functions

2.1 Port Diagram

A top-down view of the MM1-1467LCH-2 outline drawing is shown below to the left. The MM1-1467LCH-1 is shown below to the right. Both mixers are electrically identical and have mirrored footprints. The MM1-1467L has the input and output ports given in Port Functions. The MM1-1467L can be used in either an up or down conversion.

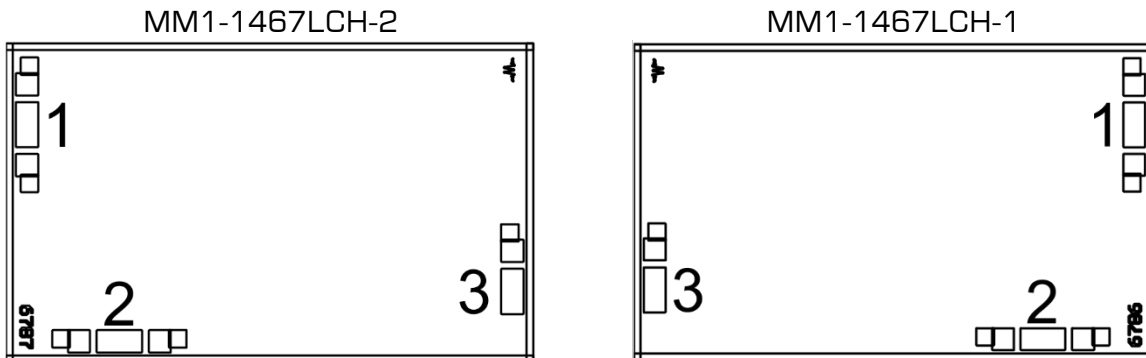

2.2 Port Functions

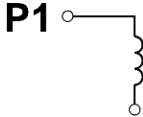
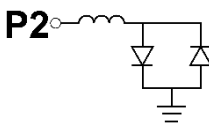
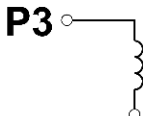
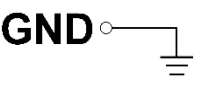
Port	Function	Description	Equivalent Circuit for Package
Port 1	LO (Configuration A) RF (Configuration B)	Port 1 is DC open for the CH and UB packages.	P1 
Port 2	IF	Port 2 is diode connected for the CH and UB package.	P2 
Port 3	RF (Configuration A) LO (Configuration B)	Port 3 is DC open for the CH and UB packages.	P3 
GND	Ground	CH package ground path is provided through the substrate and ground bond pads. UB package ground provided through metal housing and outer coax conductor.	GND 

3. Specifications

3.1 Absolute Maximum Ratings

The Absolute Maximum Ratings indicate limits beyond which damage may occur to the device. If these limits are exceeded, the device may be inoperable or have a reduced lifetime.

Parameter	Maximum Rating	Units
Port 1 DC Current	N/A	mA
Port 2 DC Current	TBD	mA
Power Handling, at any Port	+27	dBm
Operating Temperature	-55 to +100	°C
Storage Temperature	-65 to +125	°C

3.2 Package Information

Parameter	Details	Rating
ESD	Human Body Model (HBM), per MIL-STD-750, Method 1020	1A
Weight	UB Package	16 g

3.3 Recommended Operating Conditions

The Recommended Operating Conditions indicate the limits, inside which the device should be operated, to guarantee the performance given in Electrical Specifications. Operating outside these limits may not necessarily cause damage to the device, but the performance may degrade outside the limits of the electrical specifications. For limits, above which damage may occur, see Absolute Maximum Ratings.

	Min	Nominal	Max	Units
T _A , Ambient Temperature	-55	+25	+100	°C
LO Input Power	+9		+13	dBm

3.4 Sequencing Requirements

There is no requirement to apply power to the ports in a specific order. However, it is recommended to provide a 50Ω termination to each port before applying power. This is a passive diode mixer that requires no DC bias.

3.5 Electrical Specifications

The electrical specifications apply at $T_A=+25^{\circ}\text{C}$ in a 50Ω system. Typical data shown is for the connectorized UB package mixer used with a +13 dBm sine wave LO. Specifications shown for configuration A (B).

Min and Max limits apply only to our connectorized units and are guaranteed at $T_A=+25^{\circ}\text{C}$. All bare die are 100% DC tested and visually inspected.

Parameter		Test Conditions	Min	Typical	Max	Units
RF (Port 3) Frequency Range			14		67	GHz
LO (Port 1) Frequency Range			14		67	
I (Port 2) Frequency Range			0		21	
Conversion Loss (CL) ²		RF/LO = 14 - 67 GHz I = 0.091 GHz		7 (8.5)	12 (13)	dB
		RF/LO = 14 - 67 GHz I = 0.091- 21 GHz		9 (10.5)		
Noise Figure (NF) ³		RF/LO = 14 - 67 GHz I = 0.091- 21 GHz		8.5		dB
Isolation	LO to RF	RF/LO = 14 - 67 GHz		53		dB
	LO to IF	IF/LO = 14 - 67 GHz		33		
	RF to IF	RF/IF = 14 - 67 GHz		48		
Input IP3 (IIP3)		RF/LO = 14 - 67 GHz I = 0.091 GHz		+12 (+13)		dBm
Input 1 dB Gain Compression Point (P1dB)				+3 (+3.5)		dBm

² Measured as a down converter to a fixed 91 MHz IF. Unless otherwise stated, frequency conversion done using a highside LO.

³ Mixer Noise Figure typically measures within 0.5 dB of conversion loss for IF frequencies greater than 5 MHz.

3.6 Typical Performance Plots

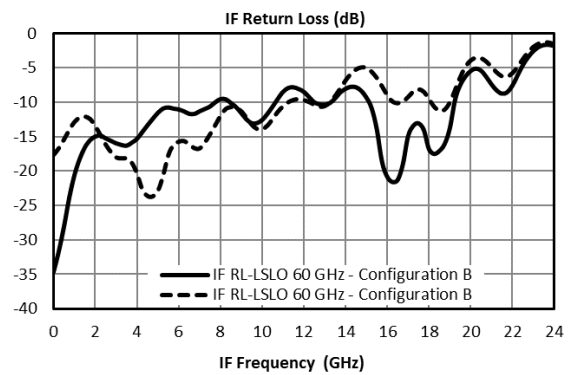
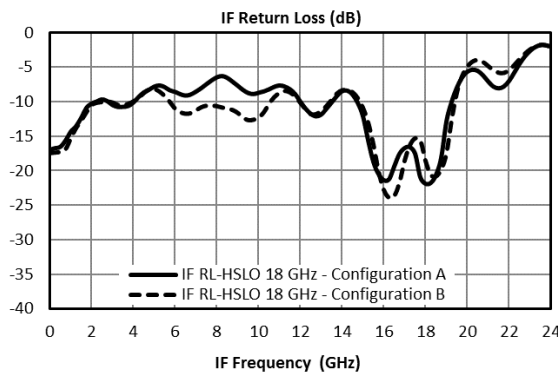
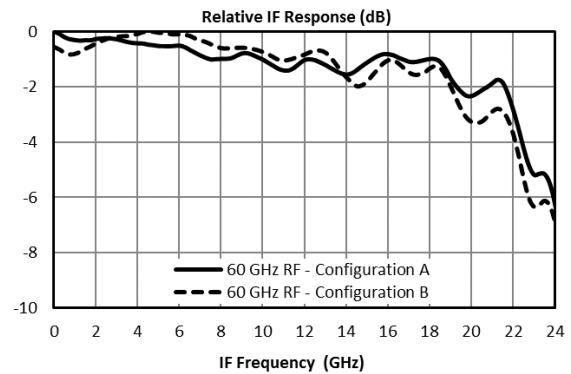
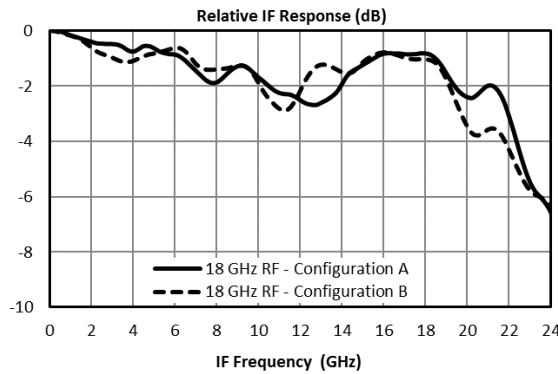
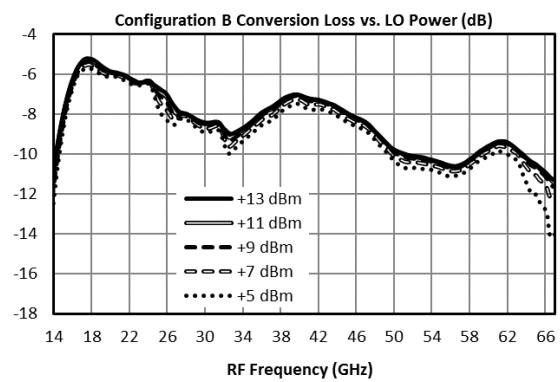
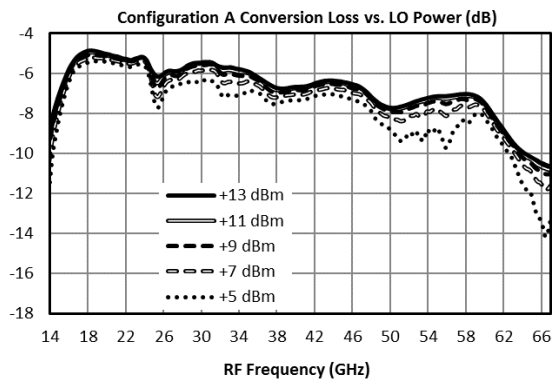
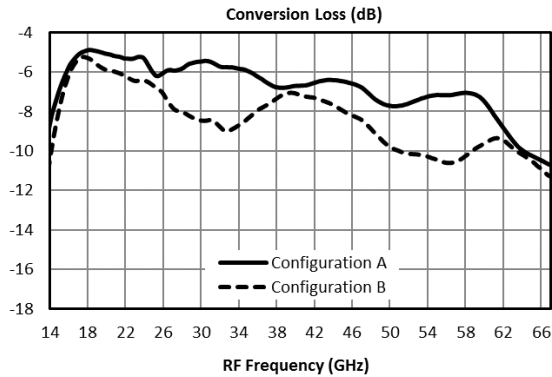

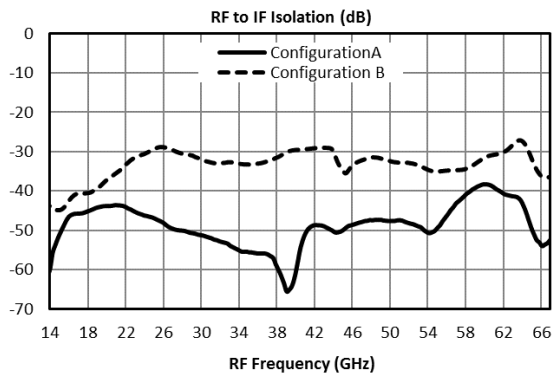
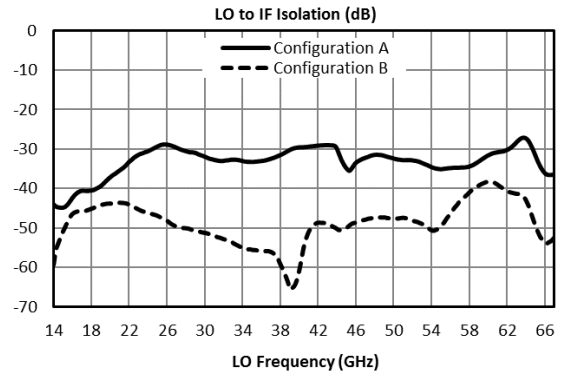
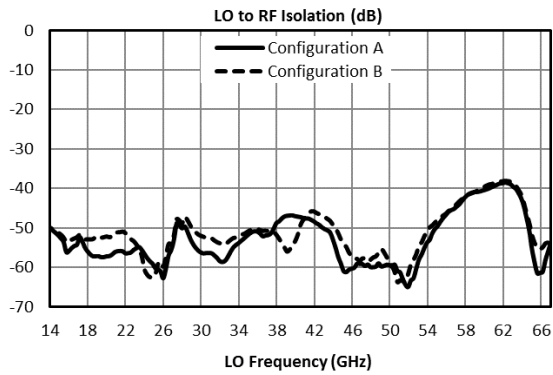
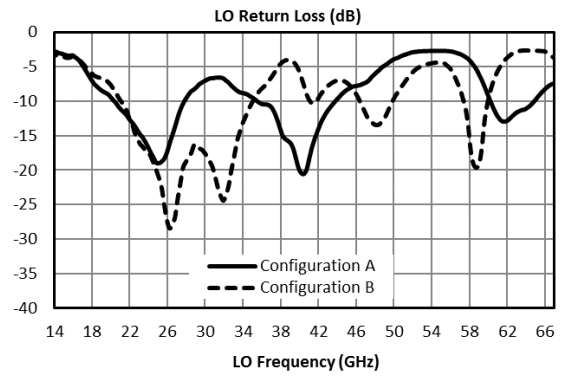
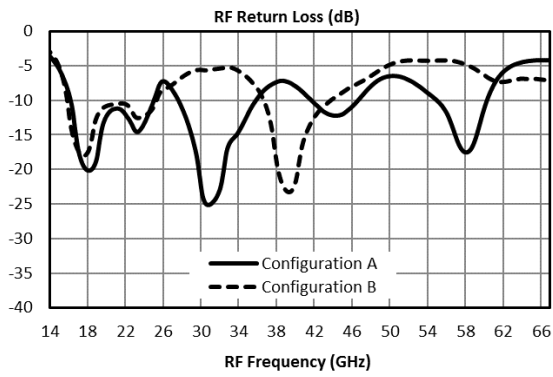

3.6.1 Typical Performance Plots: IP3

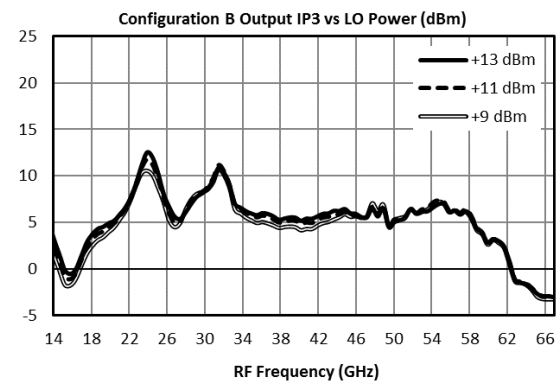
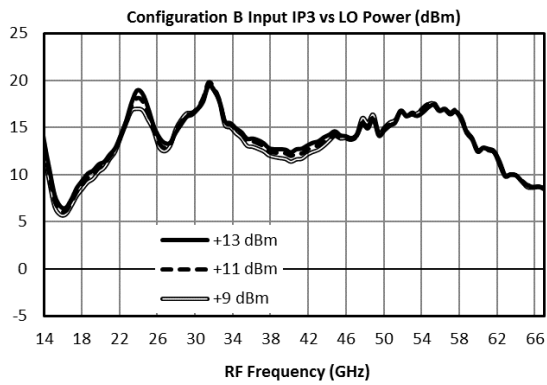
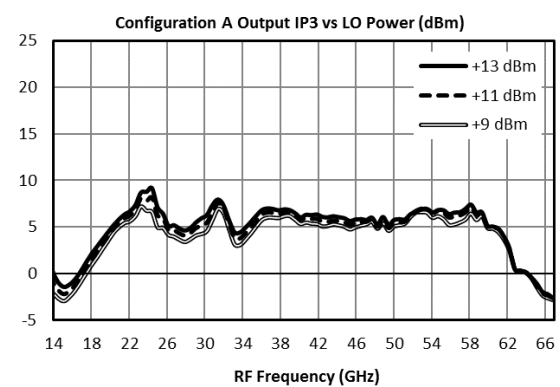
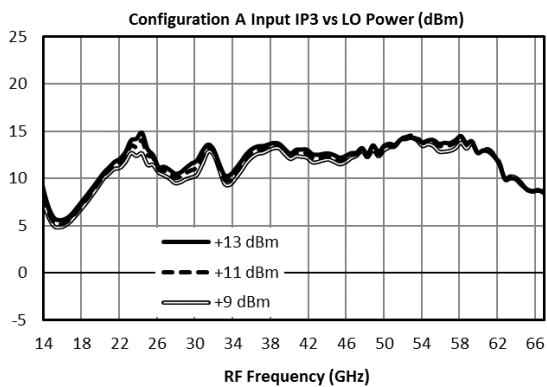
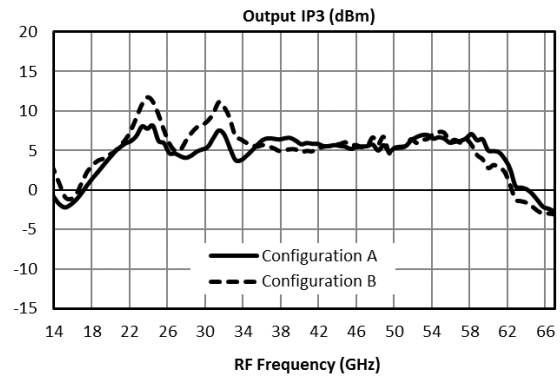
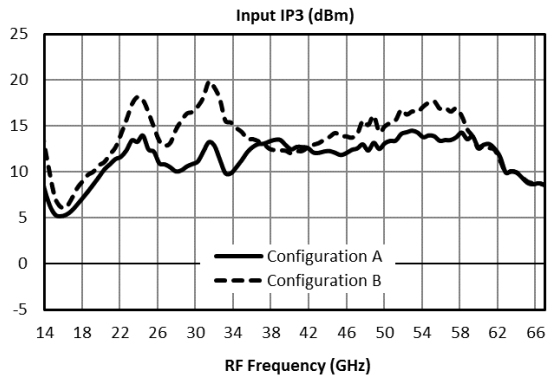

3.6.2 Typical Performance Plots: LO Harmonic Isolation

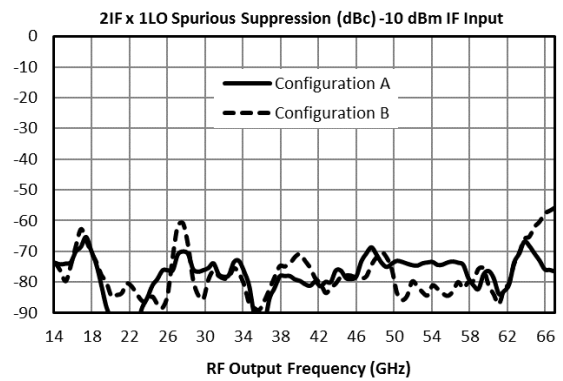
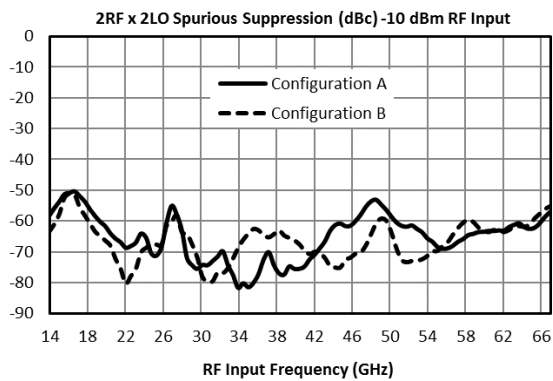
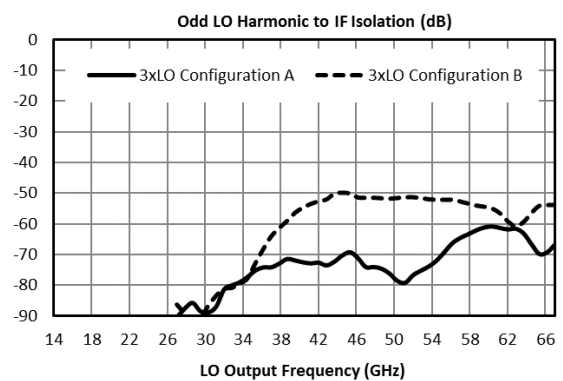
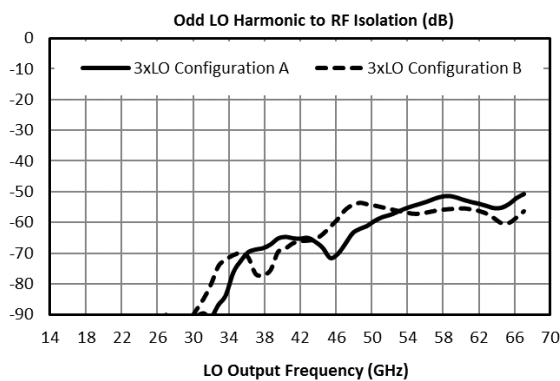
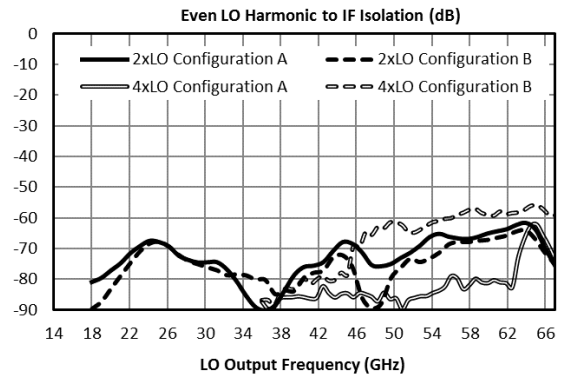
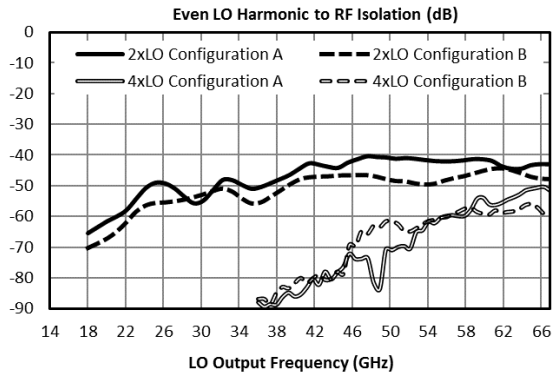

3.6.3 Typical Performance Plots: Tuner Mixer

Tuner mixer performance plots are taken with the following test conditions and frequency plan:

Parameter	Start	Nominal	Stop	Units
IF Input Frequency	0		24	GHz
IF Input Power		-10		dBm
LO Input Frequency	24		48	GHz
LO Input Power		+13		dBm
RF Output Frequency		24		GHz

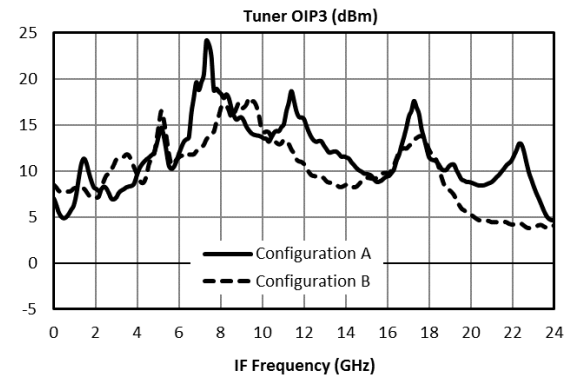
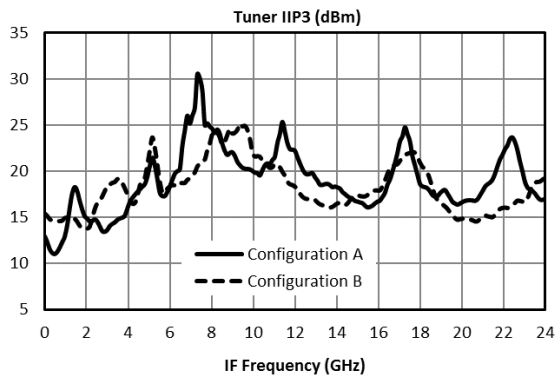
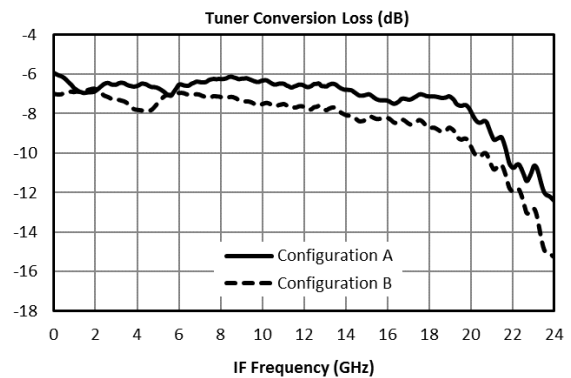
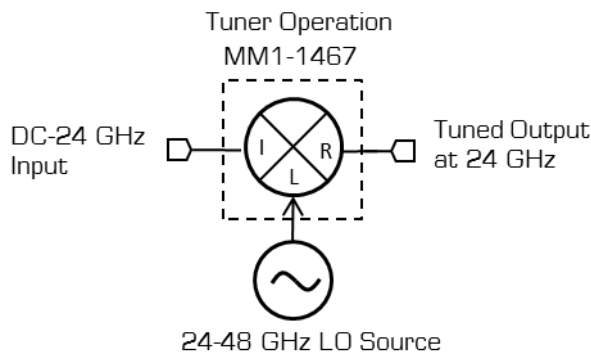

3.6.4 Typical Spurious Performance: Down-Conversion

Typical spurious data is provided by selecting RF and LO frequencies ($\pm m \cdot \text{LO} \pm n \cdot \text{RF}$) within the RF/LO bands, to create a spurious output within the IF band. The mixer is swept across the full spurious band and the mean is calculated. The numbers shown in the table below are for a -10 dBm RF input. Spurious suppression is scaled for different RF power levels by $(n-1)$, where "n" is the RF spur order. For example, the 2RF x 2LO spur is 65 dBc for a -10 dBm input, so a -20 dBm RF input creates a spur that is $(2-1) \times (-10 \text{ dB})$ lower, or 75 dBc.

Typical Down-conversion spurious suppression (dBc): Config A (B)

-10 dBm RF Input	0xLO	1xLO	2xLO	3xLO	4xLO	5xLO
1xRF	41 (25)	Reference	41 (36)	15 (13)	45 (37)	N/A
2xRF	87 (89)	48 (61)	65 (66)	56 (63)	65 (69)	63 (71)
3xRF	90 (79)	50 (50)	85 (77)	58 (62)	79 (81)	56 (61)
4xRF	115 (112)	88 (101)	94 (94)	94 (101)	102 (104)	91 (103)
5xRF	N/A	103 (108)	109 (94)	94 (100)	118 (114)	97 (105)

3.6.5 Typical Spurious Performance: Up-Conversion

Typical spurious data is taken by mixing an input within the IF band, with LO frequencies ($\pm m \cdot \text{LO} \pm n \cdot \text{IF}$), to create a spurious output within the RF output band. The mixer is swept across the full spurious output band and the mean is calculated. The numbers shown in the table below are for a -10 dBm IF input. Spurious suppression is scaled for different IF input power levels by $(n-1)$, where "n" is the IF spur order. For example, the 2IFx1LO spur is typically 78 dBc for a -10 dBm input with a sine-wave LO, so a -20 dBm IF input creates a spur that is $(2-1) \times (-10 \text{ dB})$ lower, or 88 dBc.

Typical Up-conversion spurious suppression (dBc): Config A (B)

-10 dBm RF Input	0xLO	1xLO	2xLO	3xLO	4xLO	5xLO
1xIF	40 (25)	Reference	41 (34)	14 (13)	46 (38)	N/A
2xIF	71 (70)	78 (77)	63 (66)	72 (73)	67 (71)	63 (66)
3xIF	85 (80)	59 (62)	80 (74)	56 (55)	74 (70)	47 (50)
4xIF	96 (101)	103 (105)	100 (98)	100 (97)	96 (95)	94 (101)
5xIF	120 (119)	99 (106)	117 (114)	88 (85)	110 (105)	84 (91)

4. Die Mounting Recommendations

4.1 Mounting and Bonding Recommendations

Marki MMICs should be attached directly to a ground plane with conductive epoxy. The ground plane electrical impedance should be as low as practically possible. This will prevent resonances and permit the best possible electrical performance. Datasheet performance is only guaranteed in an environment with a low electrical impedance ground.

Mounting - To epoxy the chip, apply a minimum amount of conductive epoxy to the mounting surface so that a thin epoxy fillet is observed around the perimeter of the chip. Cure epoxy according to manufacturer instructions.

Wire Bonding - Ball or wedge bond with 0.025 mm (1 mil) diameter pure gold wire. Thermosonic wirebonding with a nominal stage temperature of 150 °C and a ball bonding force of 40 to 50 grams or wedge bonding force of 18 to 22 grams is recommended. Use the minimum level of ultrasonic energy to achieve reliable wirebonds. Wirebonds should be started on the chip and terminated on the package or substrate. All bonds should be as short as possible <0.31 mm (12 mils).

Circuit Considerations – 50 Ω transmission lines should be used for all high frequency connections in and out of the chip. Wirebonds should be kept as short as possible, with multiple wirebonds recommended for higher frequency connections to reduce parasitic inductance. In circumstances where the chip more than .001” thinner than the substrate, a heat spreading spacer tab is optional to further reduce bondwire length and parasitic inductance.

4.2 Handling Precautions

General Handling

Chips should be handled with care using tweezers or a vacuum collet. Users should take precautions to protect chips from direct human contact that can deposit contaminants, like perspiration and skin oils on any of the chip's surfaces.

Static Sensitivity

GaAs MMIC devices are sensitive to ESD and should be handled, assembled, tested, and transported only in static protected environments.

Cleaning and Storage: Do not attempt to clean the chip with a liquid cleaning system or expose the bare chips to liquid. Once the ESD sensitive bags the chips are stored in are opened, chips should be stored in a dry nitrogen atmosphere.

4.3 Bonding Diagram

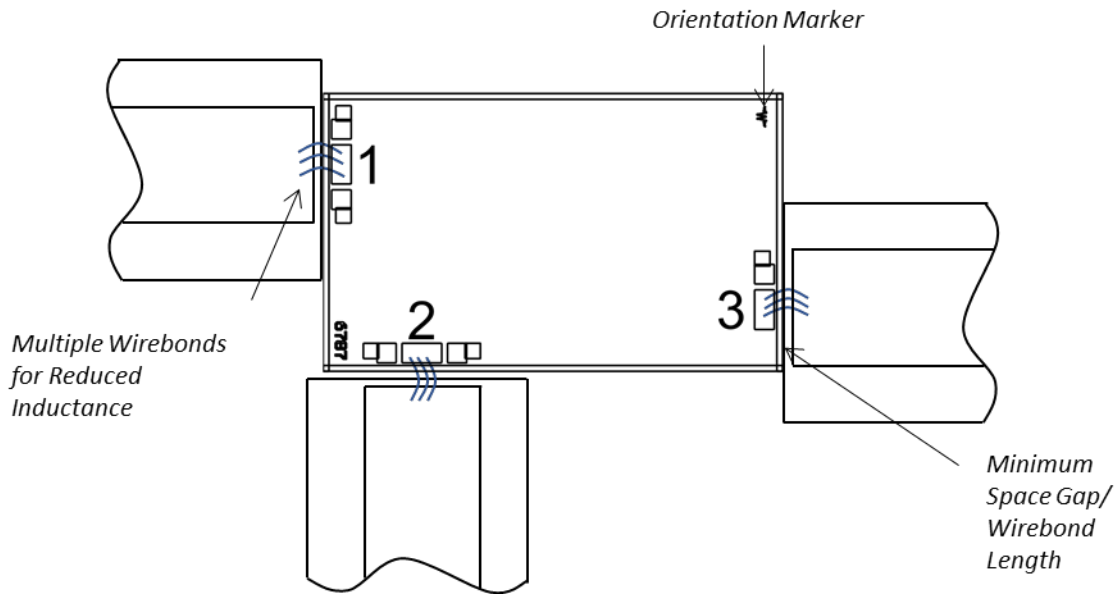

5. Mechanical Data

5.1 CH Package Outline Drawing (Option -2)

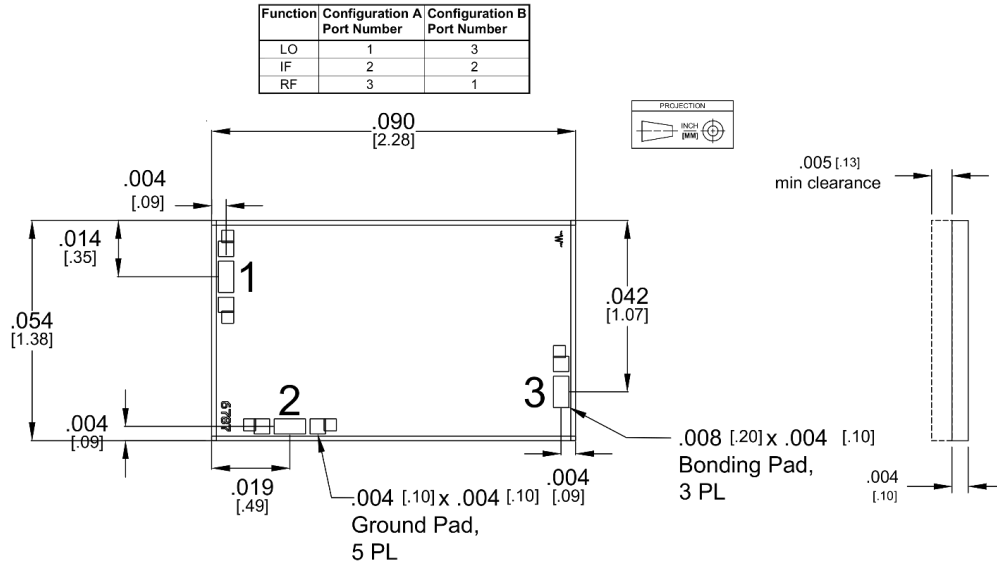

1. CH Substrate material is 0.004 in thick GaAs.
2. I/O trace finish is 4.2 microns Au. Ground plane finish is 5 microns Au.

5.2 CH Package Outline Drawing (Option -1)

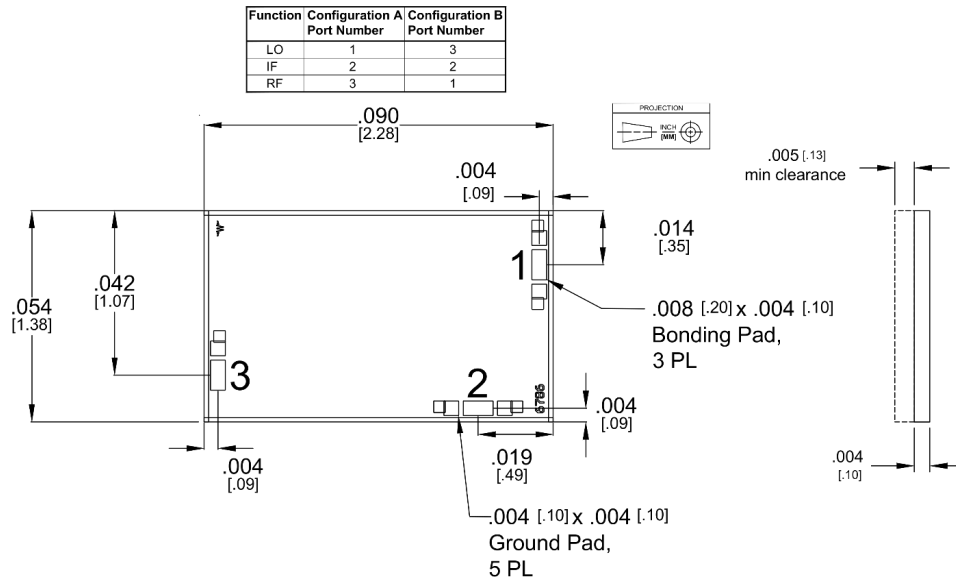

3. CH Substrate material is 0.004 in thick GaAs.
4. I/O trace finish is 4.2 microns Au. Ground plane finish is 5 microns Au.

5.3 UB Package Outline Drawing

Function	Configuration A Port Number	Configuration B Port Number	Connector Type
LO	1	3	1.85 mm Female
IF	2	2	SMA Female
RF	3	1	1.85 mm Female

Note: UB-Package Connectors are not removable

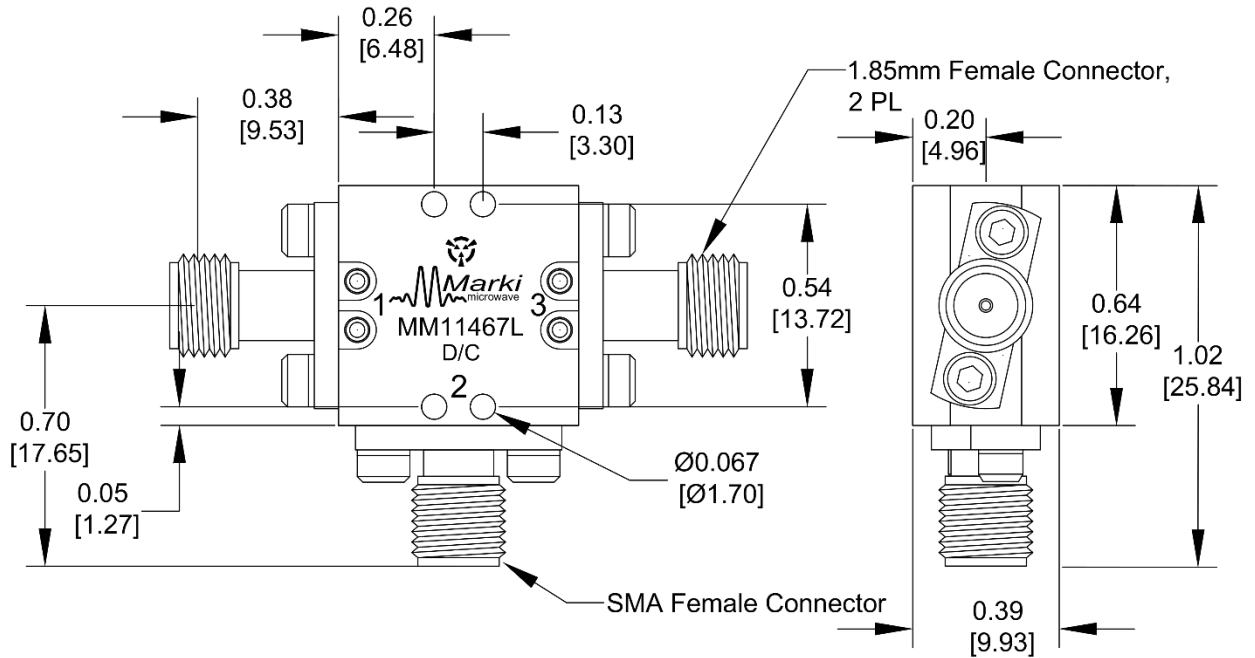
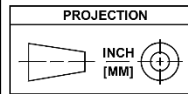

Marki Microwave reserves the right to make changes to the product(s) or information contained herein without notice.

Marki Microwave makes no warranty, representation, or guarantee regarding the suitability of its products for any particular purpose, nor does Marki Microwave assume any liability whatsoever arising out of the use or application of any product.