

MICROLITHIC™ DOUBLE-BALANCED MIXER

ML1-0936

The ML1-0936 is a Microlithic™ double balanced mixer. As with all Microlithic™ mixers (patent pending), it features excellent conversion loss, isolations, and spurious performance across a broad bandwidth and in a miniaturized form factor. Accurate, nonlinear software models are available for Microwave Office through the Marki Microwave PDK. The ML1-0936 is available as a wire bondable chip or in a connectorized package. The ML1-0936 is an excellent alternative to Marki Microwave M9 mixers packaged in drop-in carriers such as the ES carrier.

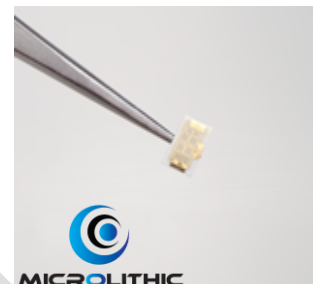

Features

- Compact Chip Style Package (0.152" x 0.090" x 0.010")
- CAD Optimized for Superior Isolation and Spurious Response
- Broadband Performance
- Excellent Unit-to-Unit Repeatability
- Fully nonlinear software models available with Marki PDK for Microwave Office
- RoHS Compliant

Electrical Specifications - Specifications guaranteed from -55 to +100°C, measured in a 50Ω system.

Parameter	LO (GHz)	RF (GHz)	IF (GHz)	Min	Typ	Max	Diode Option LO drive level (dBm)
Conversion Loss (dB)	9-36		DC-12		7	12	
Isolation (dB) LO-RF LO-IF RF-IF					See Plots		
Input 1 dB Compression (dBm)					+3 +9		L (+10 to +13) I (+15 to +19)
Input Two-Tone Third Order Intercept Point (dBm)					+13 +19		L (+10 to +13) I (+15 to +19)

Part Number Options¹

Part Number	Description	Package	Green Status	Product Lifecycle	Export Classification	Recommended Part Number
ML1-0936LCH-2	Chip	CH	RoHS Compliant	Active Not Recommended for New Designs	EAR99	MM1-1140HCH-2
ML1-0936ICH-2	Chip	CH				MM1-1140HCH-2
ML1-0936LS	Connectorized	S				MM1-1140HS
ML1-0936IS	Connectorized	S				MM1-1140HS

¹Refer to our [website](#) for a list of definitions for terminology presented in this table.

MICROLITHIC™ DOUBLE-BALANCED MIXER

ML1-0936

Page 2

LO/RF 9 to 36 GHz
IF DC to 12 GHz

Typical Performance

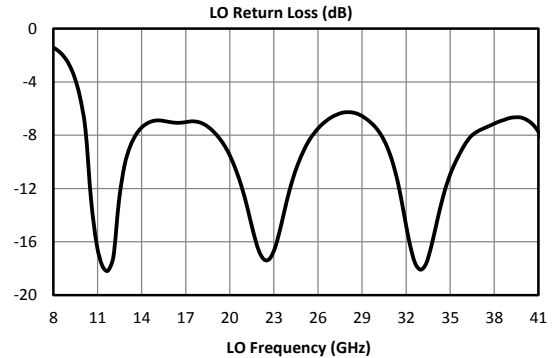
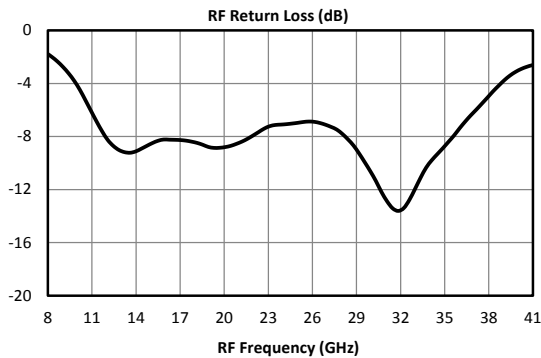
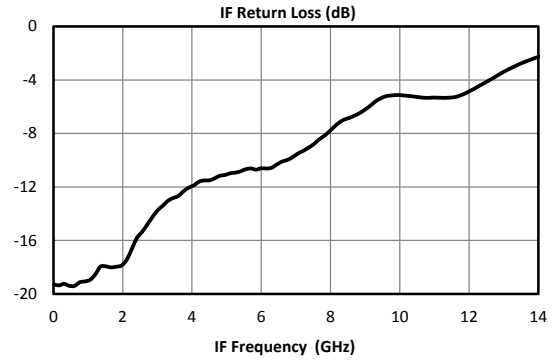
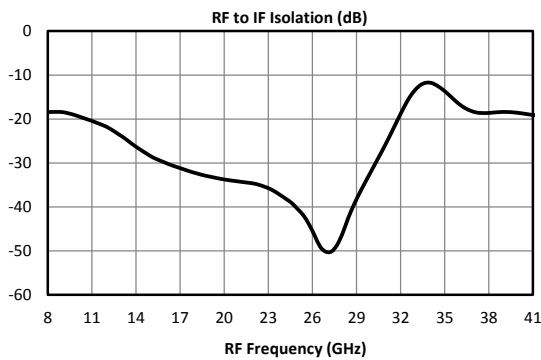
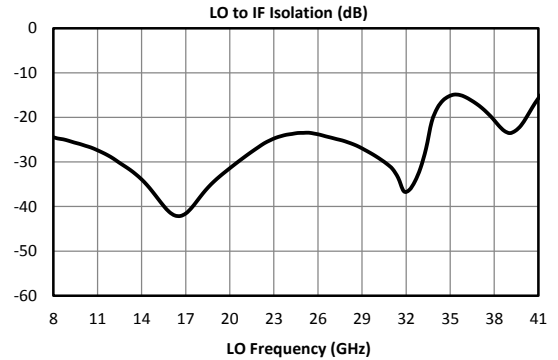
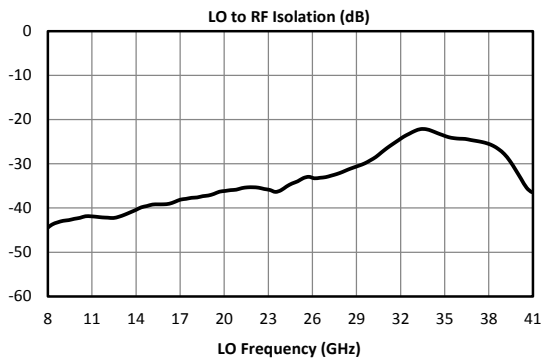
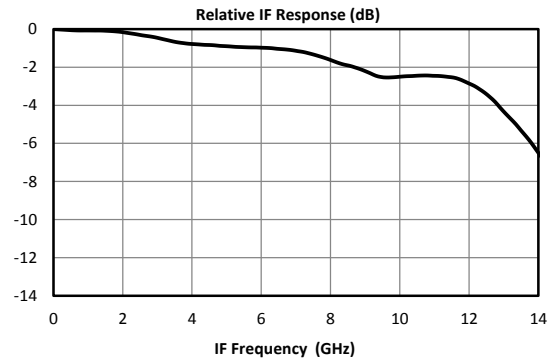
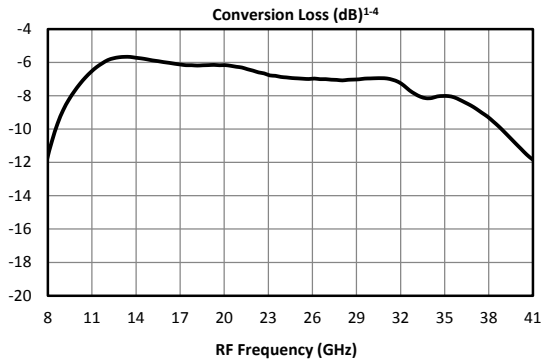

MICROLITHIC™ DOUBLE-BALANCED MIXER

ML1-0936

Page 3

LO/RF 9 to 36 GHz
IF DC to 12 GHz

Typical Performance

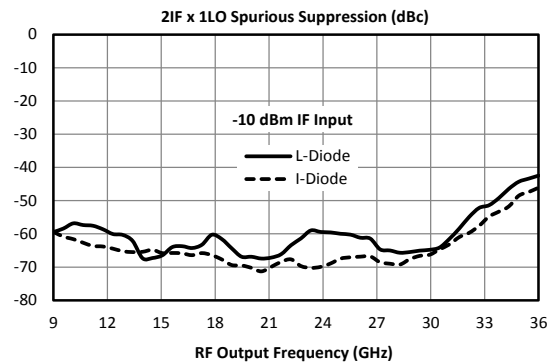
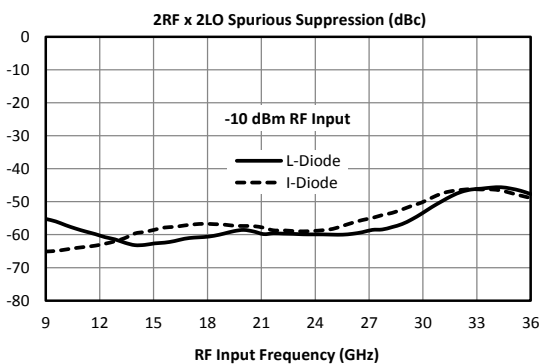
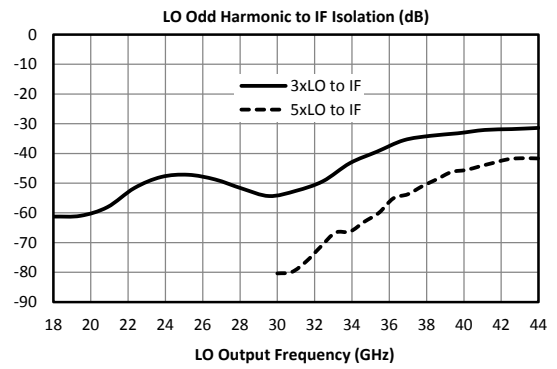
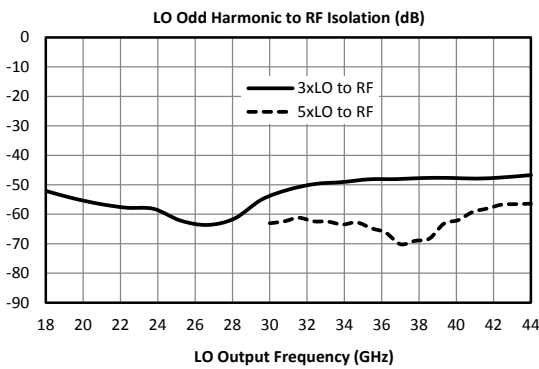
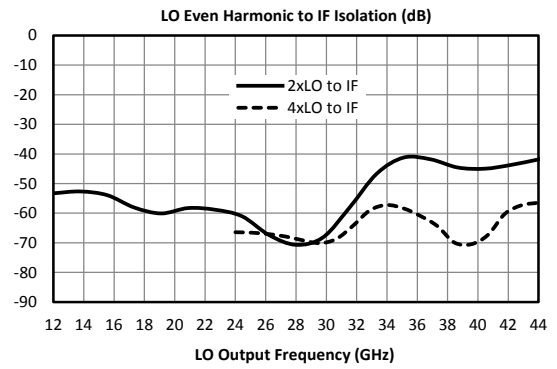
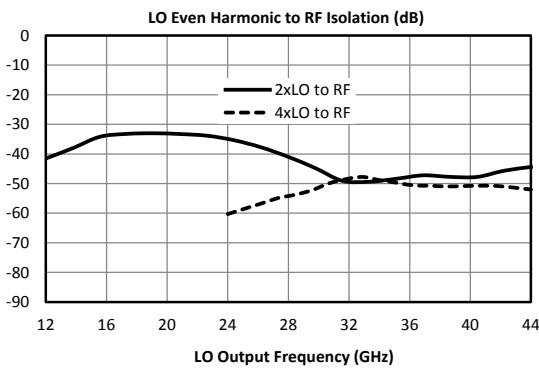
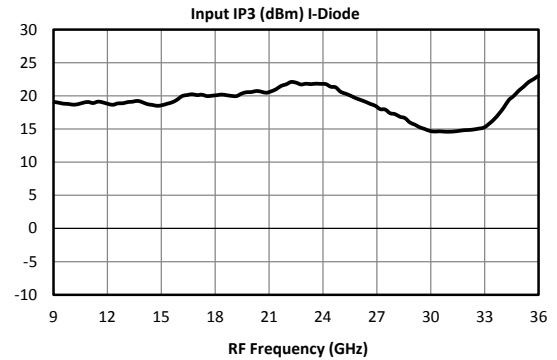
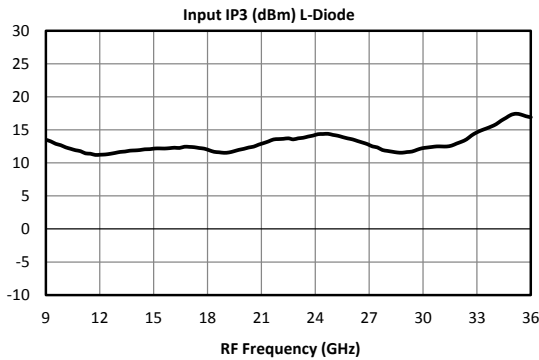

MICROLITHIC™ DOUBLE-BALANCED MIXER

ML1-0936

Page 4

LO/RF 9 to 36 GHz
IF DC to 12 GHz

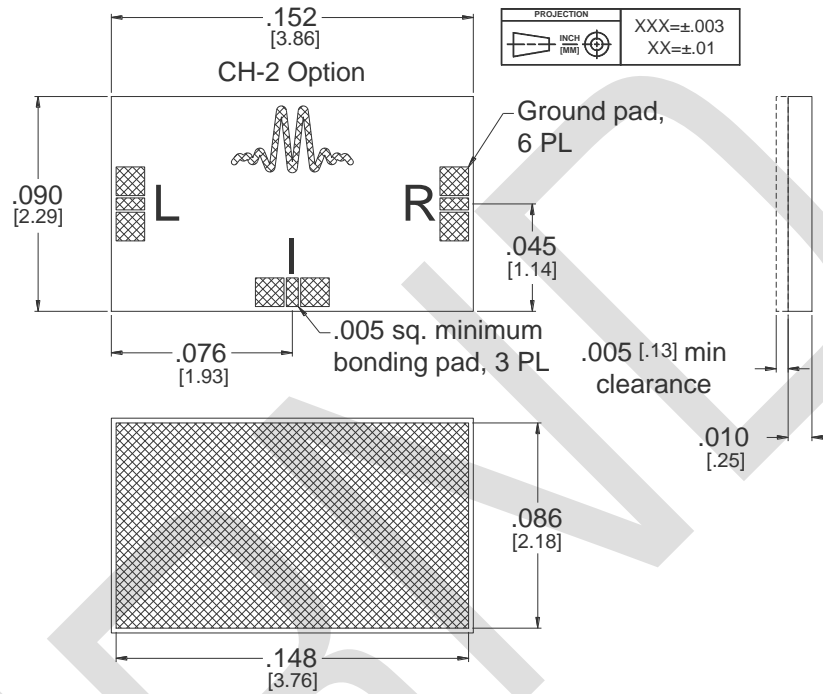

Outline Drawing – CH-2 package

*CH Substrate material is .010 thick Ceramic.

I/O traces and ground plane finish is 2.5 microns Au over .05 microns WTi.

Wire Bonding - Ball or wedge bond with 0.025 mm (1 mil) diameter pure gold wire. Thermosonic wirebonding with a nominal stage temperature of 150 °C and a ball bonding force of 40 to 50 grams or wedge bonding force of 18 to 22 grams is recommended. Use the minimum level of ultrasonic energy to achieve reliable wirebonds. Wirebonds should be started on the chip and terminated on the package or substrate. All bonds should be as short as possible <0.31 mm (12 mils).

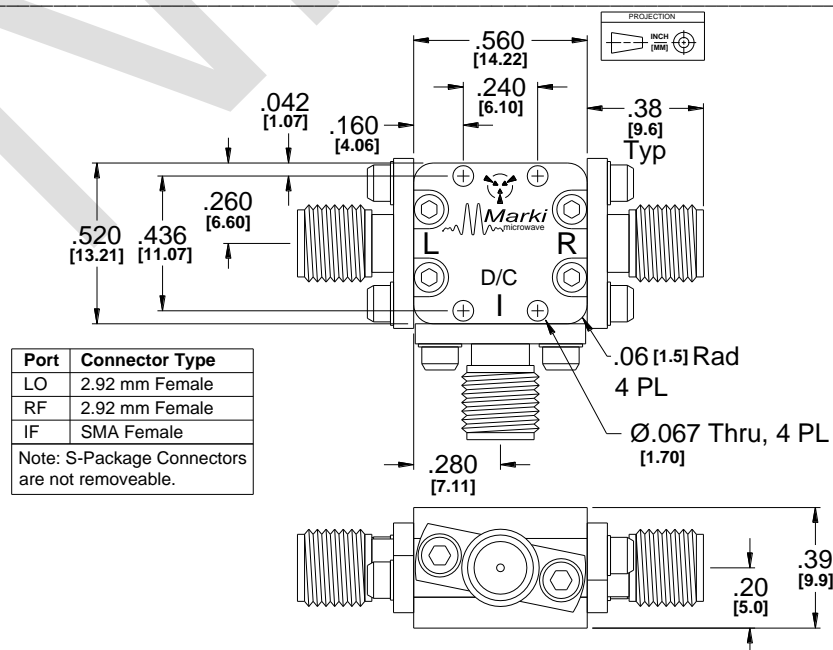

Outline Drawing – S package



MICROLITHIC™ DOUBLE-BALANCED MIXER

ML1-0936

Page 5

**LO/RF 9 to 36 GHz
IF DC to 12 GHz**

Downconversion Spurious Suppression

Spurious data is taken by selecting RF and LO frequencies ($\pm mLO \pm nRF$) within the RF/LO bands, to create a spurious output within the IF band. The mixer is swept across the full spurious band and the mean is calculated. The numbers shown in the table below are for a -10 dBm RF input. Spurious suppression is scaled for different RF power levels by $(n-1)$, where “n” is the RF spur order. For example, the $2RF \times 2LO$ spur is 56 dBc for the I-diode version for a -10 dBm input, so a -20 dBm RF input creates a spur that is $(2-1) \times (-10 \text{ dB})$ dB lower, or 66 dBc.

Typical Downconversion Spurious Suppression (dBc): I-diode (L-diode) ⁵

-10 dBm RF Input	0xLO	1xLO	2xLO	3xLO	4xLO	5xLO
1xRF	21 (21)	Reference	26 (29)	11 (12)	35 (44)	23 (24)
2xRF	68 (63)	56 (53)	56 (57)	54 (56)	62 (62)	62 (56)
3xRF	91 (77)	57 (49)	80 (68)	68 (55)	85 (69)	67 (55)
4xRF	113 (101)	96 (89)	93 (89)	102 (94)	106 (95)	107 (92)
5xRF	118 (124)	114 (100)	115 (99)	116 (97)	124 (104)	119 (94)

Upconversion Spurious Suppression

Spurious data is taken by mixing an input within the IF band, with LO frequencies ($\pm mLO \pm nIF$), to create a spurious output within the RF output band. The mixer is swept across the full spurious output band and the mean is calculated. The numbers shown in the table below are for a -10 dBm IF input. Spurious suppression is scaled for different IF input power levels by $(n-1)$, where “n” is the IF spur order. For example, the $2IF \times 1LO$ spur is typically 66 dBc for the I-diode version for a -10 dBm input, so a -20 dBm IF input creates a spur that is $(2-1) \times (-10 \text{ dB})$ dB lower, or 76 dBc.

Typical Upconversion Spurious Suppression (dBc): I-diode (L-diode) ⁵

-10 dBm IF Input	0xLO	1xLO	2xLO	3xLO	4xLO	5xLO
1xIF	18 (17)	Reference	24 (28)	10 (10)	35 (33)	27 (28)
2xIF	58 (53)	66 (59)	54 (54)	59 (57)	60 (56)	62 (62)
3xIF	101 (85)	76 (66)	79 (67)	75 (65)	83 (73)	69 (57)
4xIF	119 (106)	108 (99)	105 (92)	121 (102)	110 (96)	110 (98)
5xIF	134 (120)	125 (105)	122 (106)	131 (111)	129 (117)	127 (102)



MICROLITHIC™ DOUBLE-BALANCED MIXER

ML1-0936

Page 6

LO/RF 9 to 36 GHz
IF DC to 12 GHz

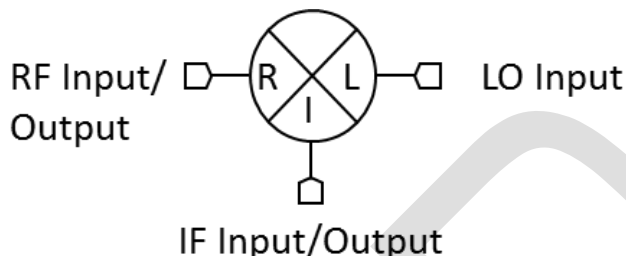

Port	Description	DC Interface Schematic
LO	The LO port is DC short to ground and AC matched to 50 Ohms from 9 GHz to 36 GHz. Blocking capacitor is optional.	
RF	The RF port is DC short to ground and AC matched to 50 Ohms from 9 GHz to 36 GHz. Blocking capacitor is optional.	
IF	The IF port is DC coupled to the diodes. Blocking capacitor is optional.	

Absolute Maximum Ratings	
Parameter	Maximum Rating
RF DC Current	1 Amp
LO DC Current	1 Amp
IF DC Current	50 mA
RF Power Handling (RF+LO)	+25 dBm at +25°C, derated linearly to +20 dBm at +100°C
Operating Temperature	-55°C to +100°C
Storage Temperature	-65°C to +125°C

DATA SHEET NOTES:

- Mixer Conversion Loss Plot IF frequency is 100 MHz.
- Mixer Noise Figure typically measures within 0.5 dB of conversion loss for IF frequencies greater than 5 MHz.
- Conversion Loss typically degrades less than 0.5 dB for LO drives 2 dB below the lowest and 3 dB above highest nominal LO drive levels.
- Conversion Loss typically degrades less than 0.5 dB at +100°C and improves less than 0.5 dB at -55°C.
- Unless otherwise specified L diode data taken with +13 dBm LO drive and I diode data is taken with +17 dBm LO drive.
- Specifications are subject to change without notice. Contact Marki Microwave for the most recent specifications and data sheets.
- Catalog mixer circuits are continually improved. Configuration control requires custom mixer model numbers and specifications.

Marki Microwave reserves the right to make changes to the product(s) or information contained herein without notice. Marki Microwave makes no warranty, representation, or guarantee regarding the suitability of its products for any particular purpose, nor does Marki Microwave assume any liability whatsoever arising out of the use or application of any product.

© Marki Microwave, Inc.

