

GaAs MMIC High Dynamic Range Mixer

MT3-0113SCQG

Page 1

The MT3-0113SCQG is a triple balanced passive diode GaAs MMIC mixer offering high dynamic range, low conversion loss, and excellent repeatability. As with all T3 mixers, this mixer offers unparalleled nonlinear performance in terms of IIP3, P_{1dB}, and spurious performance with a flexible LO drive requirement from +22 dBm to +30 dBm. The MT3-0113SCQG is available in a surface-mount outline, or in an SMA connectorized evaluation fixture. The MT3-0113SCQG is a superior alternative to Marki Microwave carrier and packaged T3 mixers, and is form-fit compatible with legacy T3's in the CQ and CQG footprints. For a list of recommended LO driver amps for all mixers and IQ mixers, see [here](#).

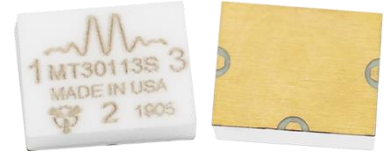

Features

- Form-Fit Compatible with Legacy CQ and CQG T3 Mixers
- Broadband, Overlapping RF, LO and IF
- Suitable for Up or Down Conversion
- Compatible with Sine or Square-Wave LO
- Industry-Leading Spurious, IP3, and P_{1dB} Performance
- Application Note: [T3 Mixer Primer](#)

Electrical Specifications - Specifications guaranteed over -40 to +100°C temperature range, measured in a 50Ω system. Specifications are shown for Configurations A (B). See page 2 for port locations. Consult factory for more information.

Parameter	LO (GHz)	RF (GHz)	IF (GHz)	Min	Typ	Max	LO drive level (dBm)
Conversion Loss (dB) ¹	1.5-13	1.5-13	0.01-0.5		8.5 (8.5)	12	+27 (+27)
			0.5-7.0		11.5 (11.5)		
Isolation (dB) LO-RF LO-IF RF-IF				See Plots			
Input 1 dB Compression (dBm) ²				See Plots		Config. A: +22 to +30 Config. B: +22 to +30	
Input Two-Tone Third Order Intercept Point (dBm) ³				+36 +35		Config. A: +22 to +30 Config. B: +22 to +30	

¹Unless otherwise specified, Conversion Loss and Spurious data is measured with a 100 MHz fixed IF.

²P_{1dB} is typically within 1-2 dB of LO drive power.

³The typical value is for a +27 dBm LO. IP3 is dependent on LO drive and waveform. See plots and data sheet notes on page 5 for more details.

Part Number Options

Model Number	Description
MT3-0113SCQG-2 ¹	RoHS Compliant Surface Mount, IF Port Configuration -2
EVAL-MT3-0113S	Connectorized Evaluation Fixture

¹Note: For port locations and I/O designations, refer to the drawings on page 2 of this document.

GaAs MMIC High Dynamic Range Mixer

MT3-0113SCQG

Page 2

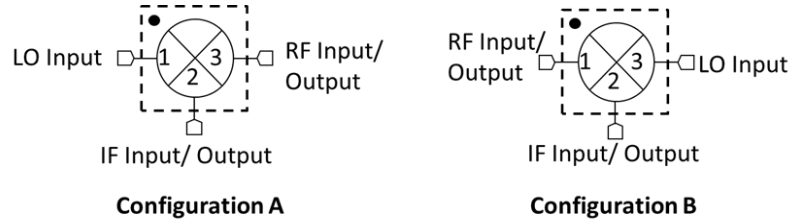

1. Configuration A/B refer to the same part number (MT3-0113SCQG) used in one of two different ways for optimal spurious performance. For the lowest conversion loss, use the mixer in Configuration A (port 1 as the LO input, port 3 as the RF input or output). If you need to use a lower LO drive, use the mixer in Configuration B (port 1 as the RF input or output, port 3 as the LO input). For optimal spurious suppression, experimentation or simulation is required to choose between Configuration A and B. For more information, [see here](#).

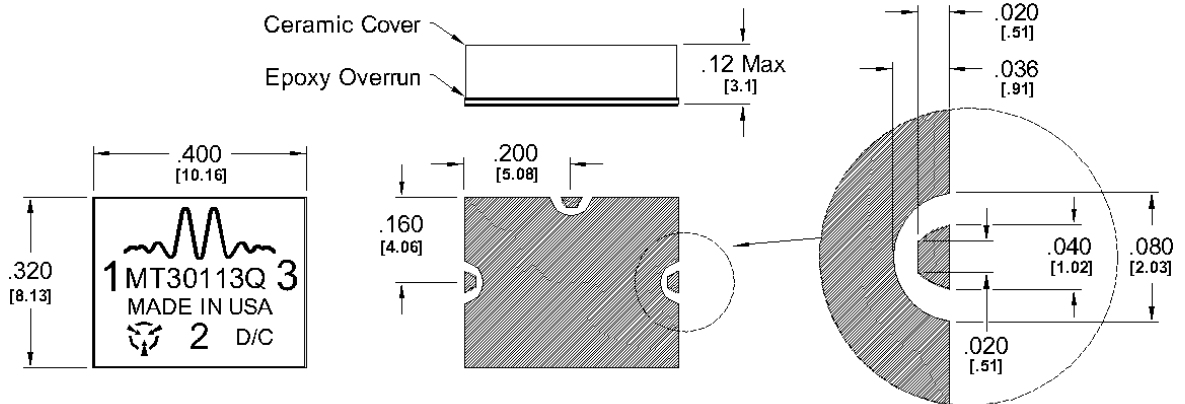

I/O Connections & Ground Plane Finish is Gold Flash, 5 to 10 μ -inches, over Solderable Nickel, 100-200 μ -inches, over Cu.

Outline Drawing – CQG-2 Package

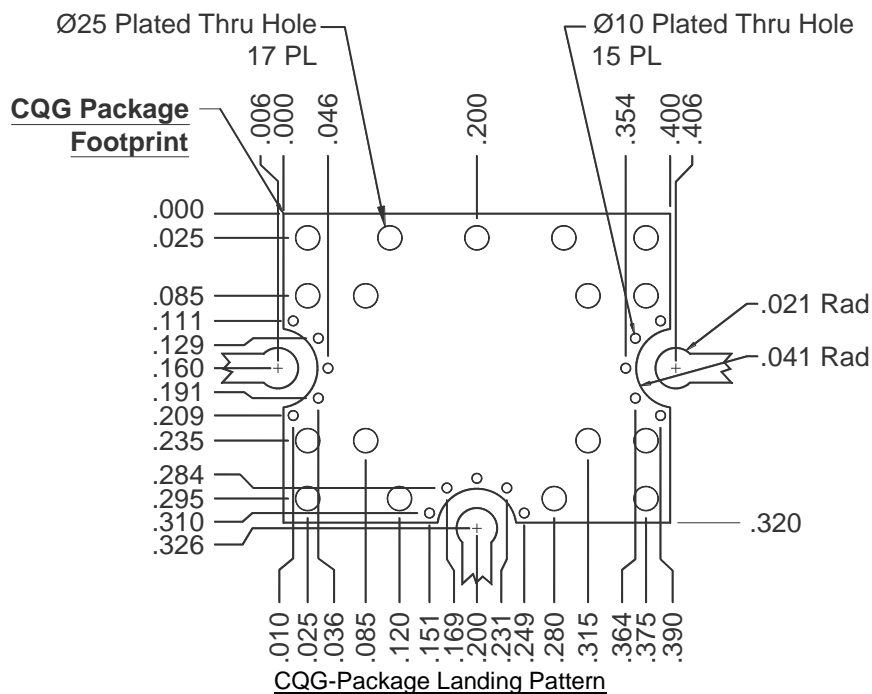

[Click here for a DXF of the above layout.](#)
[Click here for leaded solder reflow.](#) [Click here for lead-free solder reflow.](#)

GaAs MMIC High Dynamic Range Mixer

MT3-0113SCQG

Page 3

Typical Performance

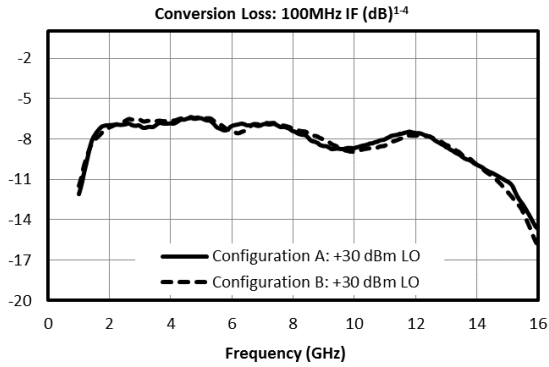

This space intentionally left blank

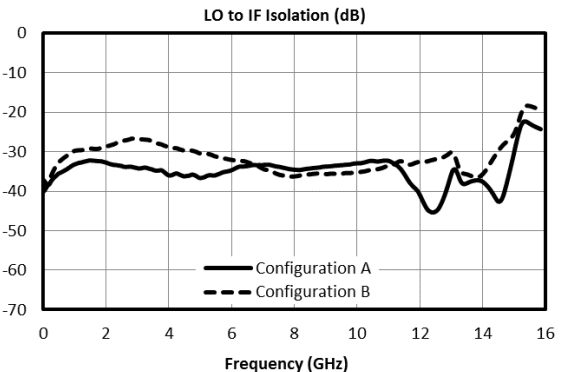
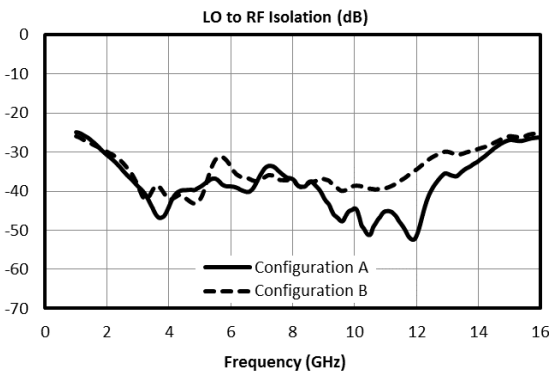
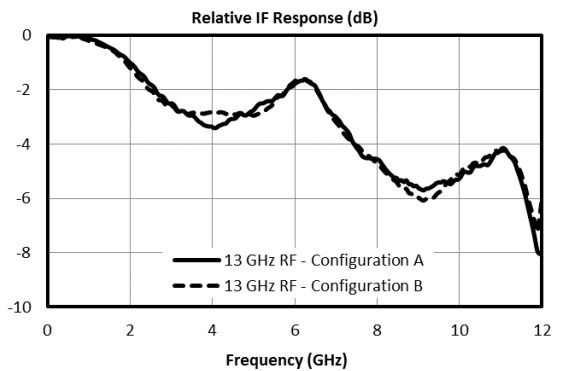
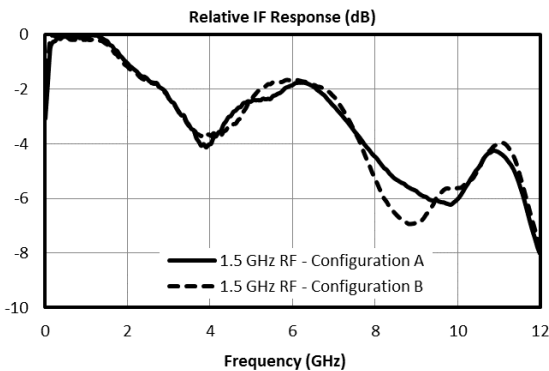
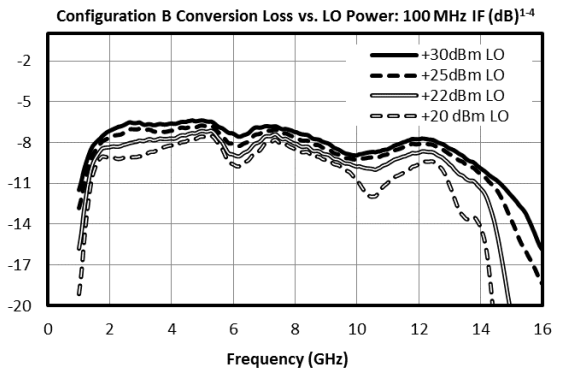
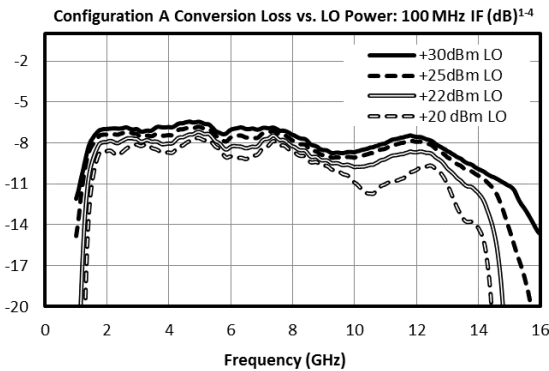

GaAs MMIC High Dynamic Range Mixer

MT3-0113SCQG

Page 4

Typical Performance

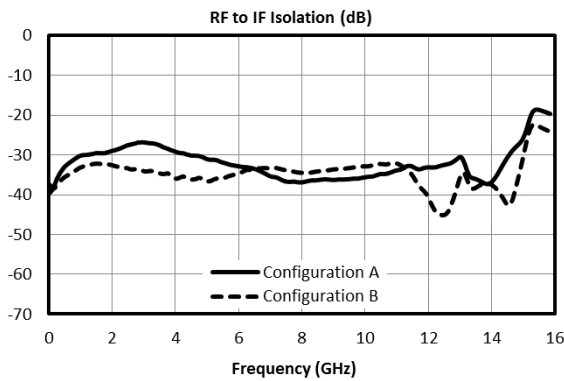
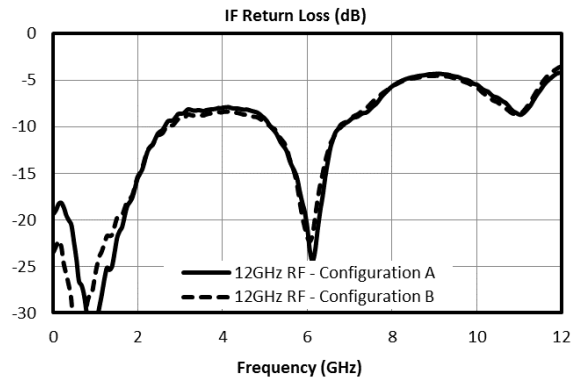
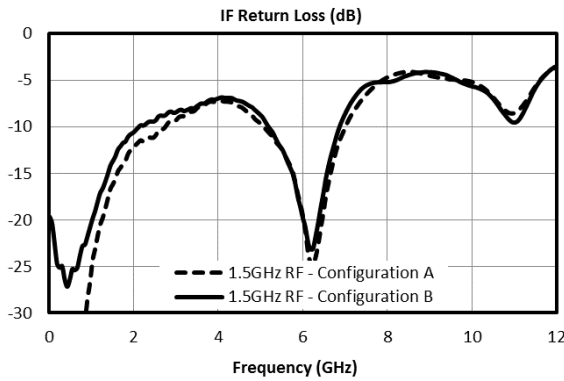
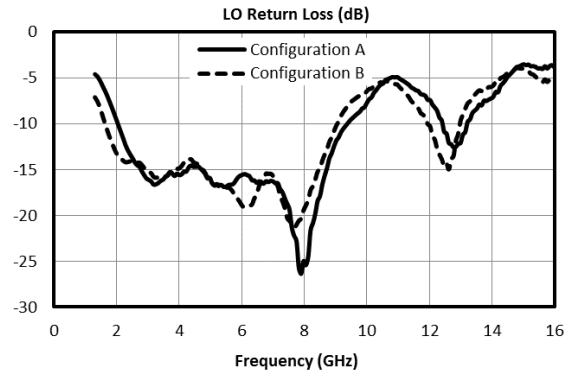
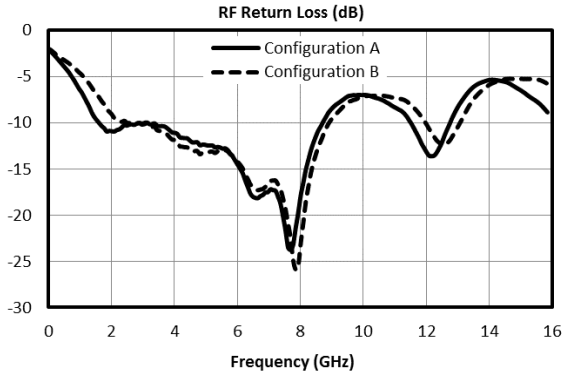

This space intentionally left blank

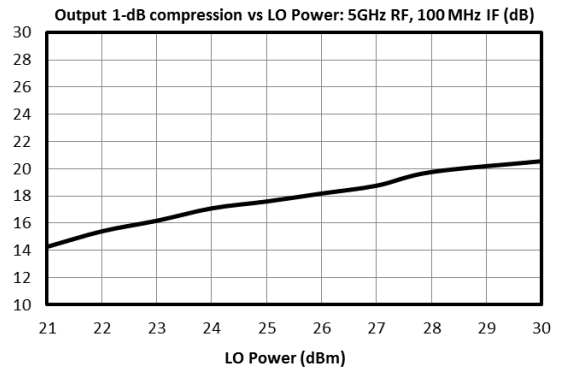
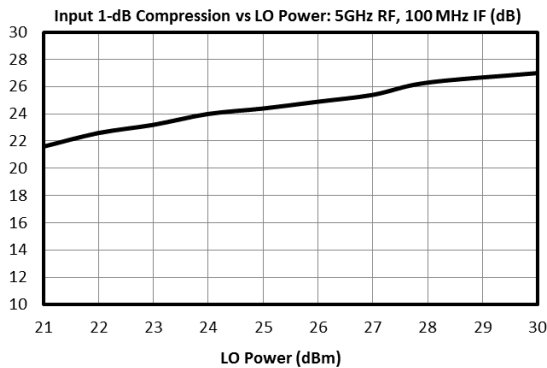

GaAs MMIC High Dynamic Range Mixer

MT3-0113SCQG

Page 5

Typical Performance

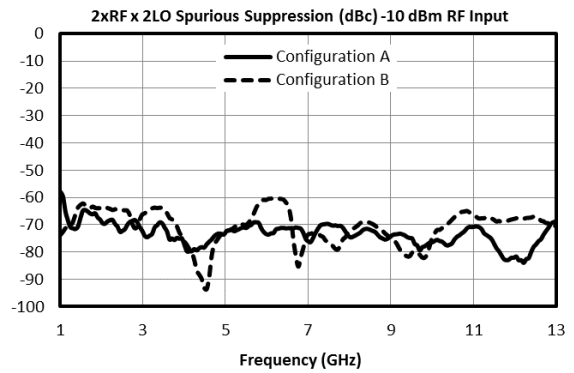
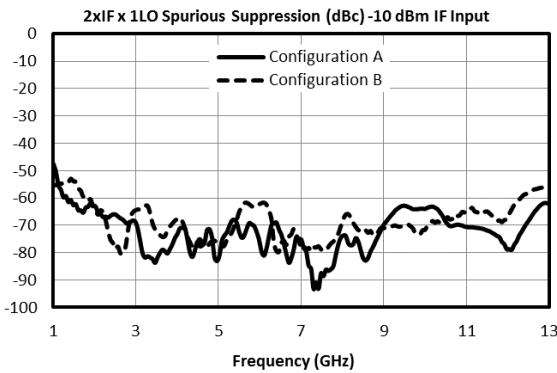
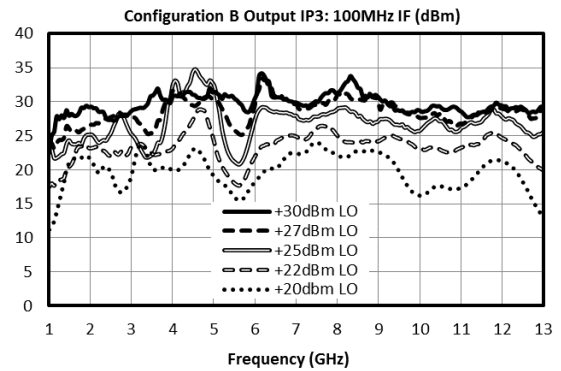
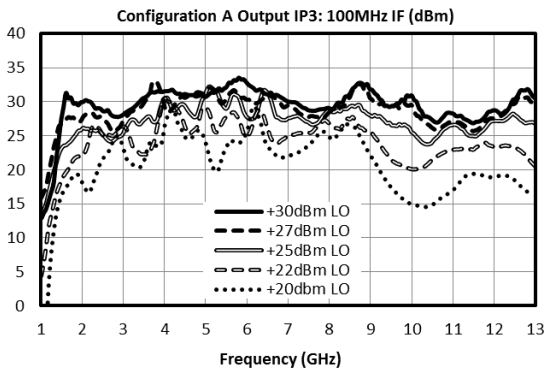
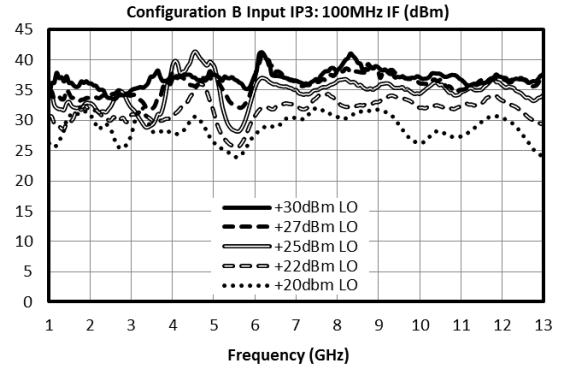
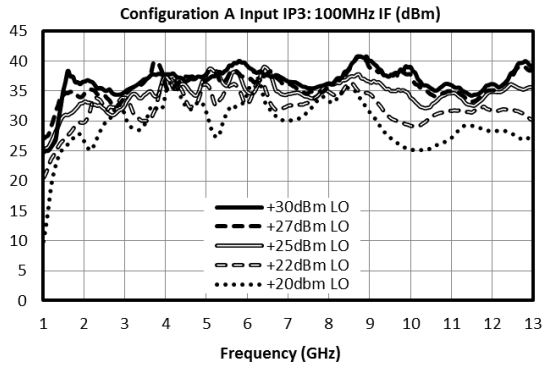

Example Downconversion Spurious Suppression

The numbers shown in the chart below are for a 0 dBm RF input. Spurious suppression is scaled for different RF power levels by (n-1), where “n” is the RF spur order. For example, the 2RFx2LO spur is 67 dBc for the A configuration for a 0 dBm input with a sine-wave LO, so a -10 dBm RF input creates a spur that is (2-1) x (-10 dB) dB lower, or 77 dBc.

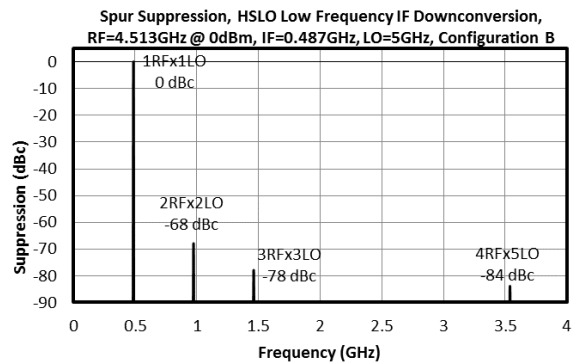
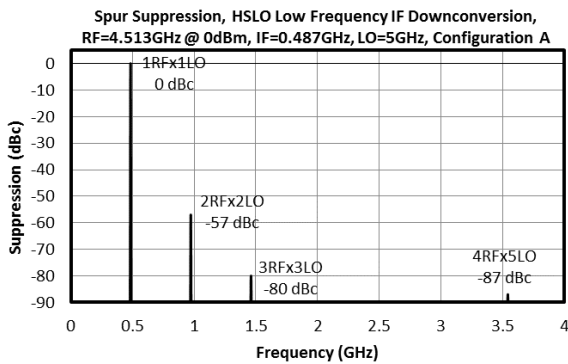
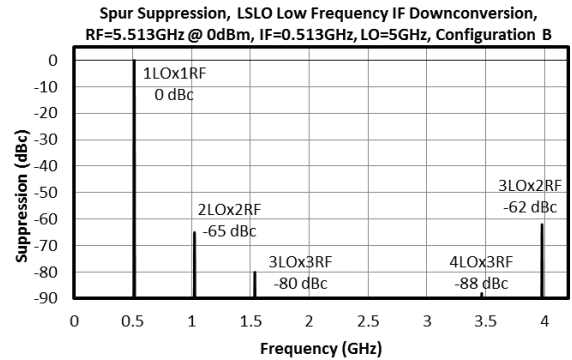
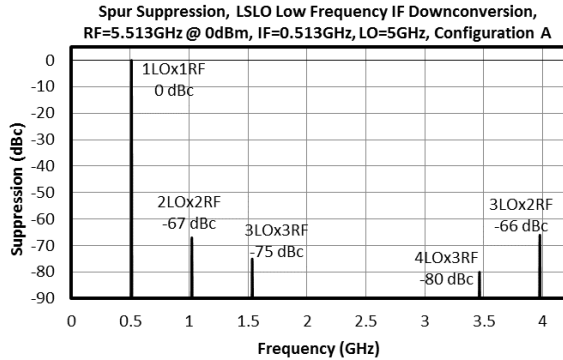

GaAs MMIC High Dynamic Range Mixer

MT3-0113SCQG

Page 7

Example Upconversion Spurious Suppression

The numbers shown in the chart below are for a 0 dBm RF input. Spurious suppression is scaled for different RF power levels by (n-1), where “n” is the RF spur order. For example, the 1LOx2IF spur is 56 dBc for the A configuration for a 0 dBm input with a sine-wave LO, so a -10 dBm IF input creates a spur that is (2-1) x (-10 dB) dB lower, or 66 dBc.

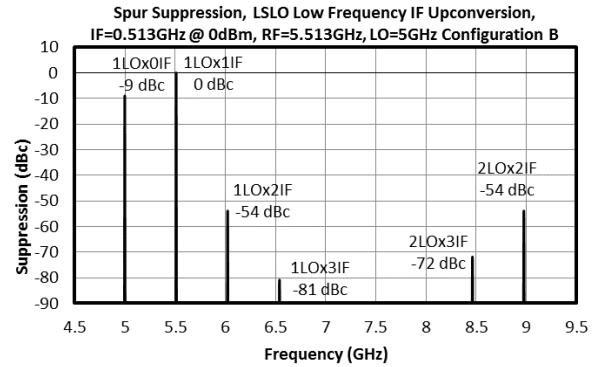
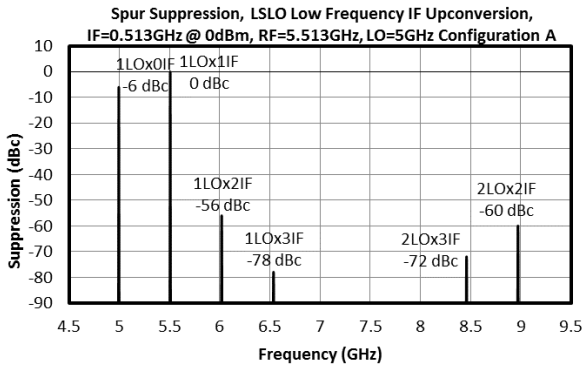
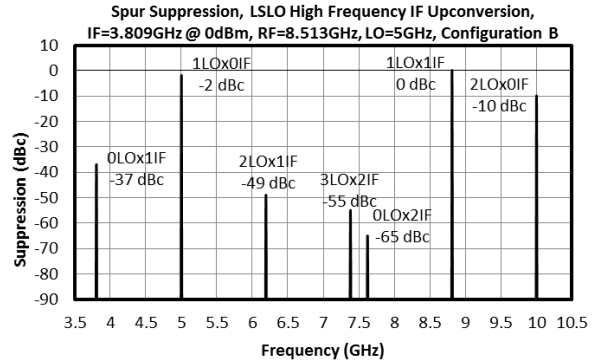
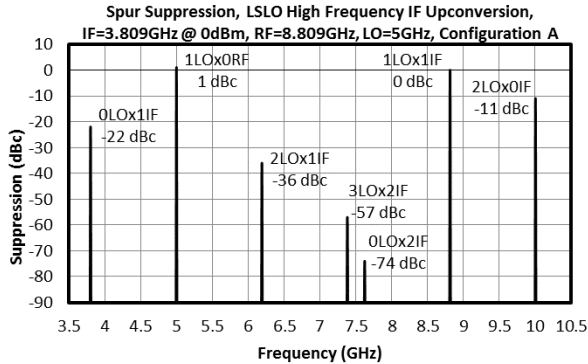

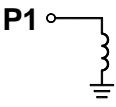
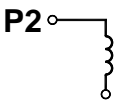
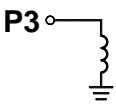
Port	Description	DC Interface Schematic
Port 1	Port 1 is DC short and AC matched to 50 Ω from 1.5 to 13 GHz. Blocking capacitor is optional.	
Port 2	Port 2 is DC open. Blocking capacitor is optional.	
Port 3	Port 3 is DC short and AC matched to 50 Ω from 1.5 to 13 GHz. Blocking capacitor is optional.	

Absolute Maximum Ratings	
Parameter	Maximum Rating
Port 1 DC Current	TBD mA
Port 2 DC Current	N/A
Port 3 DC Current	TBD mA
RF Power Handling (RF+LO)	+33 dBm
Operating Temperature	-40 to +100°C
Storage Temperature	-40 to +150°C

DATA SHEET NOTES:

- Mixer Conversion Loss Plot IF frequency is 100 MHz unless otherwise specified.
- Mixer Noise Figure typically measures within 0.5 dB of conversion loss for IF frequencies greater than 5 MHz.
- Conversion Loss typically degrades less than 0.5 dB at +100°C and improves less than 0.5 dB at -40°C.
- Unless otherwise specified, sine-wave data is taken with +27 dBm LO drive.
- Specifications are subject to change without notice. Contact Marki Microwave for the most recent specifications and data sheets.
- Catalog mixer circuits are continually improved. Configuration control requires custom mixer model numbers and specifications.

Revision History

Revision Code	Revision Date	Comment
-	August 2019	Initial Release
A	May 2020	Changed cover to ceramic

Marki Microwave reserves the right to make changes to the product(s) or information contained herein without notice. Marki Microwave makes no warranty, representation, or guarantee regarding the suitability of its products for any particular purpose, nor does Marki Microwave assume any liability whatsoever arising out of the use or application of any product.

215 Vineyard Court, Morgan Hill, CA 95037 | Ph: 408.778.4200 | Fax 408.778.4300 | info@markimicrowave.com

www.markimicrowave.com



GaAs MMIC High Dynamic Range Mixer
Page 9

MT3-0113SCQG