

GaAs MMIC Double Balanced Mixer

MM1-1850SSM

1. Device Overview

1.1 General Description

The MM1-1850SSM is a GaAs MMIC double balanced mixer that operates at high frequency in a proprietary surface mount package. MM1-1850SSM is a K/Ka band mixer that works well as both an up and down converter. This mixer offers exceptionally high frequency RF bandwidth for a surface mount mixer and high spurious suppression. The sister MM1-1850HSM is recommended for lower LO power applications. The MM1-1850SSM is available in a proprietary 4x4 mm package. Evaluation boards are available.

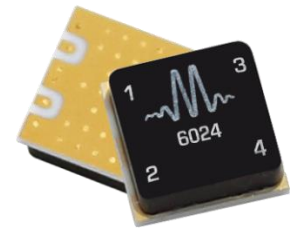

KFN

1.2 Features

- High Linearity
- High Frequency Operation
- RoHS Compliant

1.3 Applications

- Electronic Warfare Scanners
- 5G Test Receivers
- Recommended Surface Mount Amplifier: [AMM-6702SM](#)

1.4 Functional Block Diagram

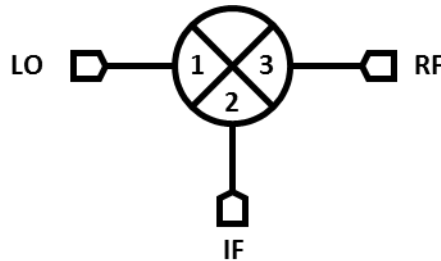

1.5 Part Ordering Options¹

Part Number	Description	Package	Green Status	Product Lifecycle	Export Classification
MM1-1850SSM-2	4x4 mm SMT	KFN	RoHS	Active	EAR99
EVAL-MM1-1850S	Connectorized Evaluation Fixture	Eval		Active	EAR99

¹ Refer to our [website](#) for a list of definitions for terminology presented in this table.

Table of Contents

1. Device Overview	1	3.6 Typical Performance Plots	6
1.1 General Description	1	3.6.1 Typical Performance Plots: IP3 ..	7
1.2 Features	1	3.6.2 Typical Performance Plots: Spurious Suppression	7
1.3 Applications	1	3.6.3 Typical Performance Plots: Tuner Mixer.....	8
1.4 Functional Block Diagram	1	3.6.4 Typical Spurious Performance: Down-Conversion	9
1.5 Part Ordering Options.....	1	3.6.5 Typical Spurious Performance: Up- Conversion	9
2. Port Configurations and Functions	3	3.6.6 Typical Spurious Performance: Tuner Mixer.....	10
2.1 Port Diagram	3	4. Operation.....	11
2.2 Port Functions	3	4.1 Application Circuit	11
3. Specifications	4	4.2 Ports Operation	11
3.1 Absolute Maximum Ratings.....	4	5. Mechanical Data.....	12
3.2 Package Information.....	4	5.1 KFN Package Outline Drawing....	12
3.3 Recommended Operating Conditions 4		5.2 KFN Package Footprint	12
3.4 Sequencing Requirements.....	4		
3.5 Electrical Specifications	5		

Revision History

Revision Code	Revision Date	Comment
-	May 2019	Datasheet Release
A	July 2019	Corrected SM Package Dimension Callout



2. Port Configurations and Functions

2.1 Port Diagram

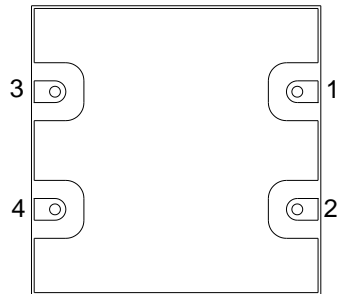
A bottom-up view of the MM1-1850SSM's KFN package outline drawing is shown below. The MM1-1850SSM has the input and output ports given in Port Functions. The MM1-1850SSM can be used in either an up or down conversion. For configuration A, input the LO into pin 1, use pin 3 for the RF, and pin 2 for the IF. For configuration B, input the LO into pin 3, use pin 1 for the RF, and pin 2 for the IF.

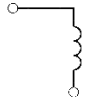
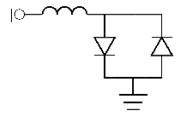
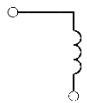

2.2 Port Functions

Port	Function	Description	DC Interface Schematic
Pin 1	LO (Configuration A) RF (Configuration B)	Pin 1 is DC open and AC matched to 50 Ohms from 18 to 50 GHz.	
Pin 2	IF	Port 2 is DC coupled to the diodes. Blocking capacitor is optional.	
Pin 3	RF (Configuration A) LO (Configuration B)	Pin 3 is DC open and AC matched to 50 Ohms from 18 to 50 GHz	
Pin 4	NC	Pin 4 is not connected internally and should be connected to RF ground.	
GND	Ground	KFN package ground path is provided through the ground paddle.	

3. Specifications

3.1 Absolute Maximum Ratings

The Absolute Maximum Ratings indicate limits beyond which damage may occur to the device. If these limits are exceeded, the device may be inoperable or have a reduced lifetime.

Parameter	Maximum Rating	Units
Power Handling, at any Port	+30	dBm
Operating Temperature	TBD	°C
Storage Temperature	TBD	°C

3.2 Package Information

Parameter	Details	Rating
ESD	Human Body Model (HBM), per MIL-STD-750, Method 1020	1A
Weight	EVAL package	TBD
MSL	J-STD-020	TBD

3.3 Recommended Operating Conditions

The Recommended Operating Conditions indicate the limits, inside which the device should be operated, to guarantee the performance given in Electrical Specifications. Operating outside these limits may not necessarily cause damage to the device, but the performance may degrade outside the limits of the electrical specifications. For limits, above which damage may occur, see Absolute Maximum Ratings.

	Min	Nominal	Max	Units
T _A , Ambient Temperature		+25		°C
LO Input Power	+20		+28	dBm

3.4 Sequencing Requirements

There is no requirement to apply power to the ports in a specific order. However, it is recommended to provide a 50Ω termination to each port before applying power. This is a passive diode mixer that requires no DC bias.

3.5 Electrical Specifications

The electrical specifications apply at TA=+25°C in a 50Ω system. Typical data shown is for a down conversion application with the LO driven with an [AMM-6702UC](#) with +10 dBm input power biased at +4/-0.4V. Specifications shown for configuration A. Configuration B may be suitable for conversions below 45 GHz.

Parameter		Test Conditions	Min	Typical	Max	Units
RF Frequency Range			18		50	GHz
LO Frequency Range			18		45	
IF Frequency Range			0		21	
Conversion Loss (CL) ²		RF = 18 - 50 GHz LO = 18 - 45 GHz IF = DC - 0.2 GHz		7.9	12	dB
		RF = 18 - 50 GHz LO = 18 - 45 GHz IF = 0.2 - 21 GHz		9.7		
Noise Figure (NF) ³		RF = 18 - 50 GHz LO = 18 - 45 GHz IF = DC - 0.2 GHz		9.7		dB
Isolation	LO to RF	RF/LO = 18 - 50 GHz		28		dB
	LO to IF	IF/LO = 18 - 50 GHz		26		
	RF to IF	RF/IF = 18 - 50 GHz		25		
Input IP3 (IIP3)		RF/LO = 18 - 45 GHz IF = DC - 0.2 GHz		+28		dBm
Output IP3 (OIP3)		RF/LO = 18 - 45 GHz IF = DC - 0.2 GHz		+19		dBm
Input 1 dB Gain Compression Point (P1dB)				+14		dBm

² Measured as a down converter to a fixed 91MHz IF.

³ Mixer Noise Figure typically measures within 0.5 dB of conversion loss for IF frequencies greater than 5 MHz.

3.6 Typical Performance Plots

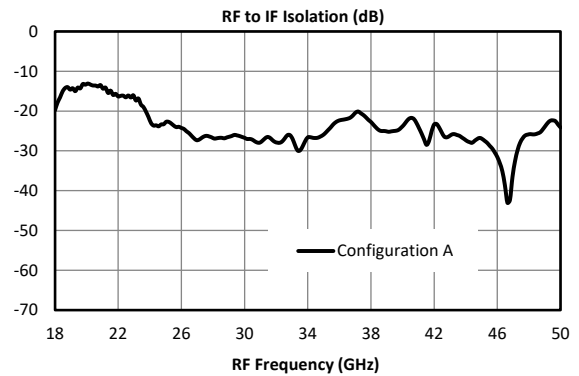
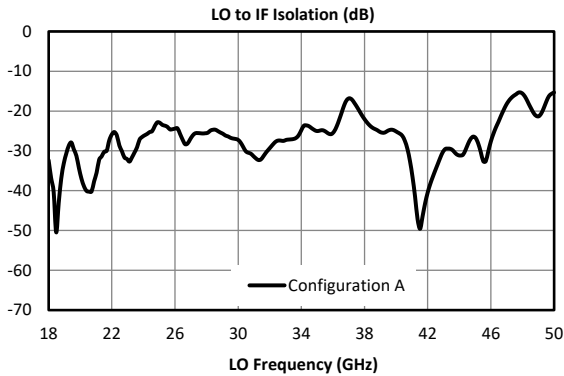
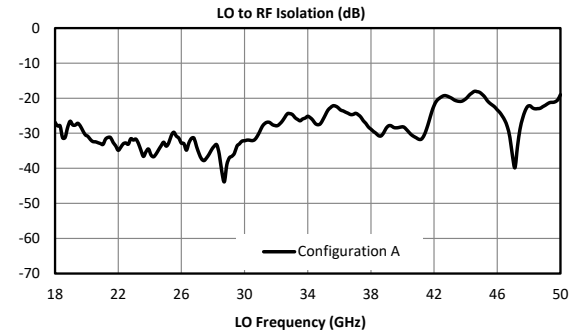
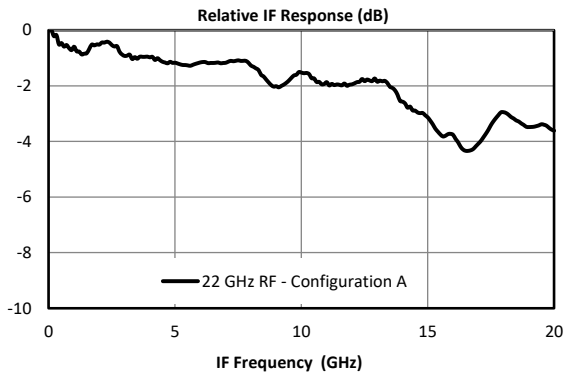
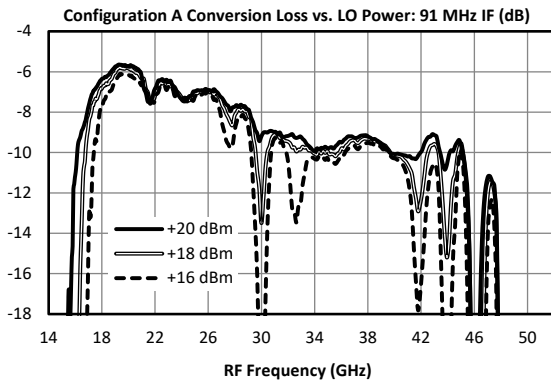
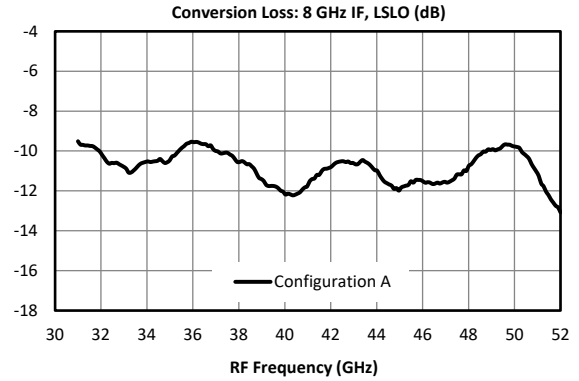
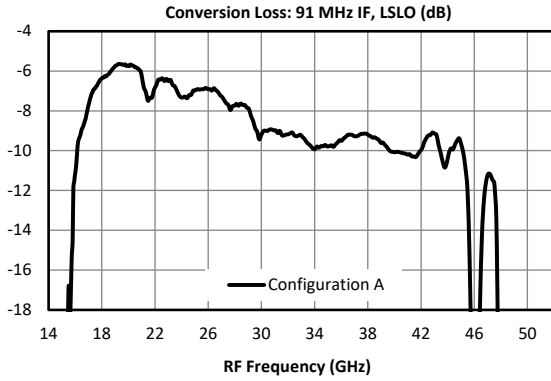

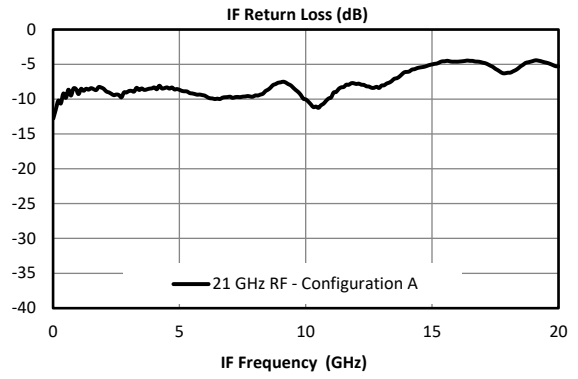
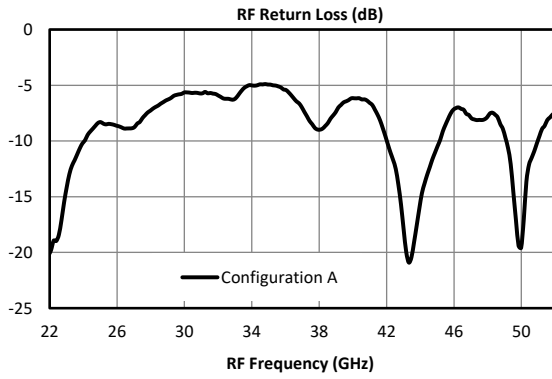

3.6.1 Typical Performance Plots: IP3

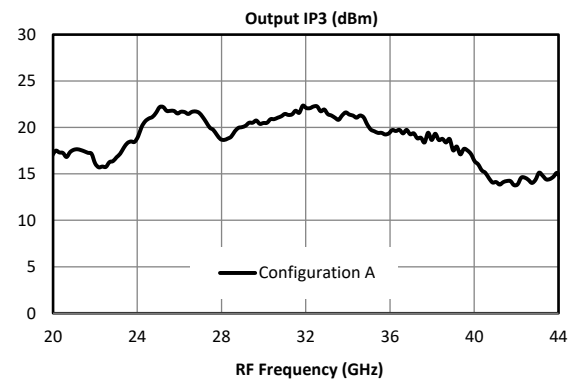
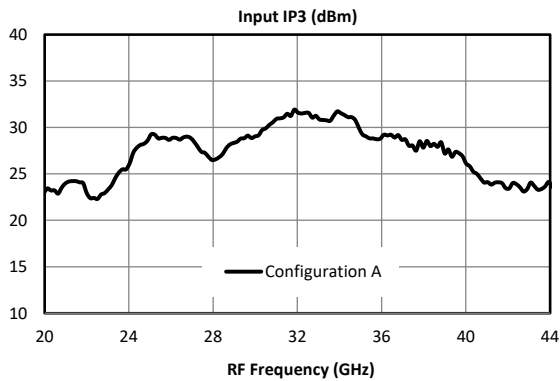

3.6.2 Typical Performance Plots: Spurious Suppression

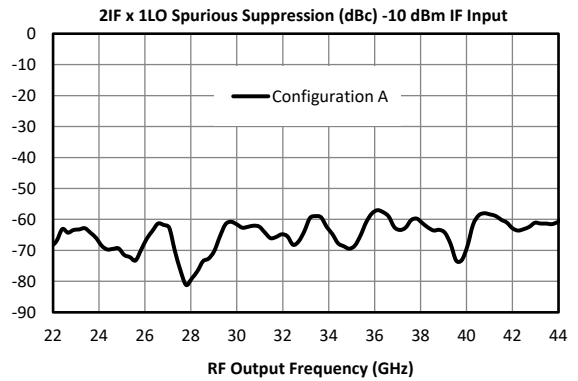
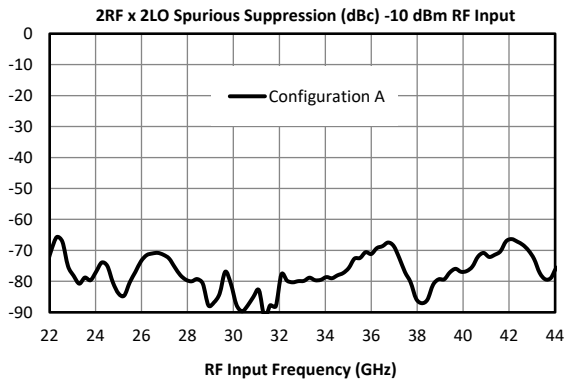

3.6.3 Typical Performance Plots: Tuner Mixer

Tuner mixer performance plots are taken with the following test conditions and frequency plan:

Parameter	Start	Nominal	Stop	Units
IF Input Frequency	0		20	GHz
IF Input Power		-10		dBm
LO Input Frequency	22		42	GHz
RF Output Frequency		22		GHz

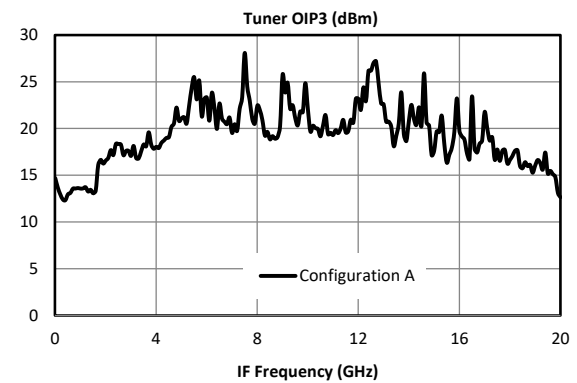
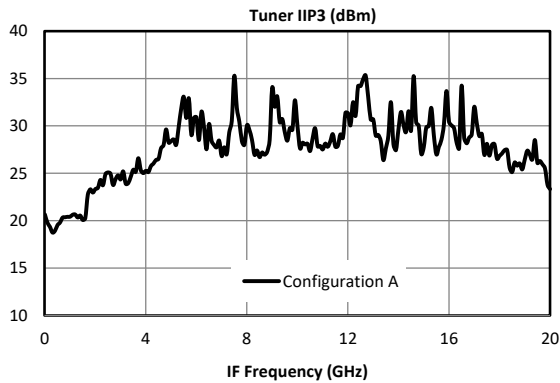
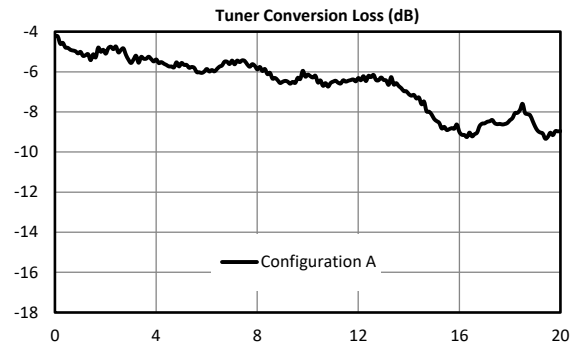
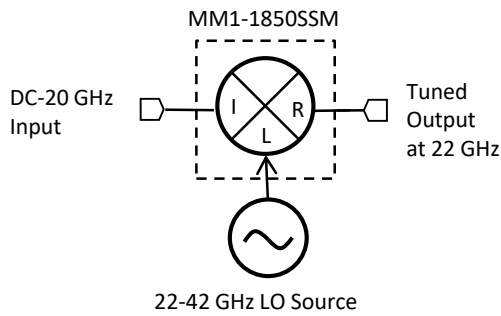

3.6.4 Typical Spurious Performance: Down-Conversion

Typical spurious data is provided by selecting RF and LO frequencies ($\pm m \cdot \text{LO} \pm n \cdot \text{RF}$) within the RF/LO bands, to create a spurious output within the IF band. The mixer is swept across the full spurious band and the mean is calculated. The numbers shown in the table below are for a -10 dBm RF input. Spurious suppression is scaled for different RF power levels by $(n-1)$, where “n” is the RF spur order. For example, the $2\text{RF} \times 2\text{LO}$ spur is 77 dBc for a -10 dBm input, so a -20 dBm RF input creates a spur that is $(2-1) \times (-10 \text{ dB})$ lower, or 87 dBc. Data is shown for the frequency plan in Typical Performance. $m\text{LO} \times n\text{RF}$ plots can be found in section 3.6.2 Typical Performance Plots: . $\text{LO} \times 1\text{RF}$ plot is identical to the plot of LO-RF isolation.

Typical Down-conversion spurious suppression (dBc): Config A

-10 dBm RF Input	0xLO	1xLO	2xLO	3xLO	4xLO	5xLO
1xRF	27	Reference	25	15	NA	NA
2xRF	85	59	77	71	70	NA
3xRF	NA	70	87	86	93	90
4xRF	NA	NA	121	122	121	127
5xRF	NA	NA	NA	135	132	131

3.6.5 Typical Spurious Performance: Up-Conversion

Typical spurious data is taken by mixing an input within the IF band, with LO frequencies ($\pm m \cdot \text{LO} \pm n \cdot \text{IF}$), to create a spurious output within the RF output band. The mixer is swept across the full spurious output band and the mean is calculated. The numbers shown in the table below are for a -10 dBm IF input. Spurious suppression is scaled for different IF input power levels by $(n-1)$, where “n” is the IF spur order. For example, the $2\text{IF} \times 1\text{LO}$ spur is typically 64 dBc for a -10 dBm input with a sine-wave LO, so a -20 dBm IF input creates a spur that is $(2-1) \times (-10 \text{ dB})$ lower, or 74 dBc. Data is shown for the frequency plan in Typical Performance.

Typical Up-conversion spurious suppression (dBc): Config A

-10 dBm IF Input	0xLO	1xLO	2xLO	3xLO	4xLO	5xLO
1xIF	13	Reference	16	11	NA	NA
2xIF	56	64	59	63	71	NA
3xIF	79	78	72	74	76	70
4xIF	101	116	67	113	110	111
5xIF	116	126	119	124	121	122

3.6.6 Typical Spurious Performance: Tuner Mixer

The following spurs are present in a typical tuner mixer conversion application

Typical Tuner Mixer spurious suppression (dBc): Config A

-10 dBm IF Input	-2xLO	-1xLO	0xLO	1xLO	2xLO	3xLO	4xLO
-5xIF	NA	NA	NA	NA	NA	NA	125
-4xIF	NA	NA	NA	112	114	118	115
-3xIF	NA	NA	NA	78	86	86	NA
-2xIF	NA	NA	NA	61	63	NA	NA
2xIF	NA	NA	53	NA	NA	NA	NA
3xIF	NA	85	86	NA	NA	NA	NA
4xIF	115	107	NA	NA	NA	NA	NA

4. Operation

4.1 Application Circuit

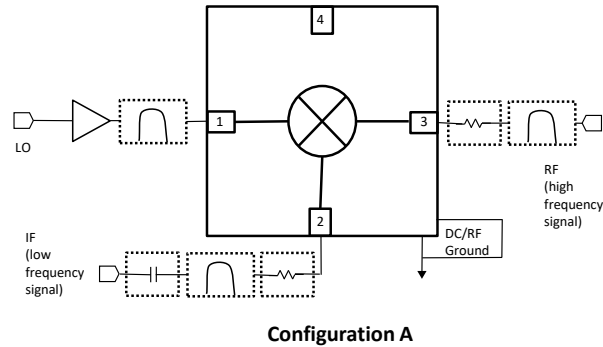

4.2 Ports Operation

IF Port – Used as input on an upconversion, output on downconversion, or LO port in a band shifting application. Signals should be connected by 50 ohm microstrip or coplanar traces to well matched broadband 50 ohm sources and loads. Blocking capacitor is recommended if DC voltage is present on the line.

RF Port – Used as input on a downconversion, output on upconversion, or output in a band shifting application. Signals should be connected by 50 ohm microstrip or coplanar traces to well matched broadband 50 ohm sources and loads.

Filtering and Matching- Filtering is generally desired for spurious and image removal on the output port of the mixer. Reflective filters can cause out of band signals to reflect back into the mixer and cause conversion loss ripple, erroneous spurs, and other undesired behaviors. To eliminate these problems it is recommend that the filters be placed as close to the output port as possible. If undesired behavior is still observed, a diplexer with one port terminated or a 1-3 dB attenuator may reduce this problem.

RF Ground – The ground paddle of the QFN should be connected to a low noise RF ground with very low electrical resistance for high frequency operation.

LO Port – The noise floor of the LO input signal should be less than the value of the noise floor plus isolation of the mixer, or a filter is recommended to prevent reduction in dynamic range. An LO amplifier is required if the LO power is below the recommended drive level. It is important to use an amplifier with a broadband 50 ohm match such that it does not reflect spurious signals back into the mixer or other system circuitry.

5. Mechanical Data

5.1 KFN Package Outline Drawing

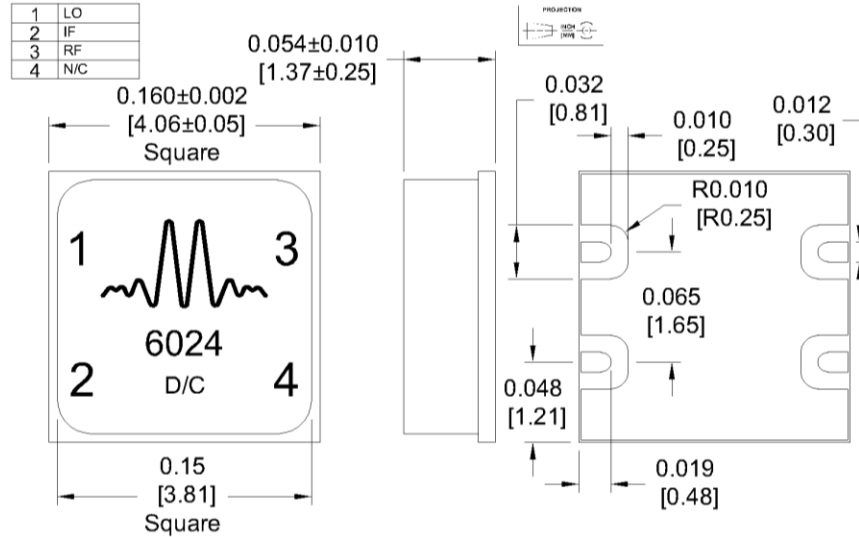

1. Substrate material is ceramic.
2. I/O Leads and Ground Paddle plating is TiW/NiAu, 0.51 μm max Au.
3. All unconnected pads should be connected to PCB RF ground.

5.2 KFN Package Footprint

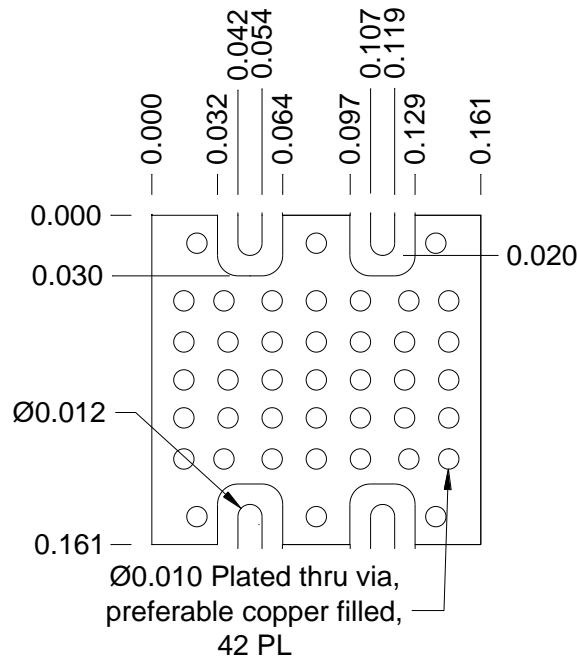

KFN-Package Surface-Mount Landing Pattern

[Click here for a DXF of the above layout.](#)

[Click here for leaded solder reflow.](#) [Click here for lead-free solder reflow](#)

Marki Microwave reserves the right to make changes to the product(s) or information contained herein without notice.

Marki Microwave makes no warranty, representation, or guarantee regarding the suitability of its products for any particular purpose, nor does Marki Microwave assume any liability whatsoever arising out of the use or application of any product.