

GaAs MMIC Double Balanced Mixer

MM1-1850HSM

1. Device Overview

1.1 General Description

The MM1-1850HSM is a GaAs MMIC double balanced mixer that operates at high frequency in a proprietary surface mount package. MM1-1850HSM is a K/Ka band mixer that works well as both an up and down converter. This mixer offers exceptionally high frequency RF bandwidth for a surface mount mixer and high spurious suppression. The sister MM1-1850SSM is recommended for high linearity applications. The MM1-1850HSM is available in a proprietary 4x4 mm package. Evaluation boards are available.

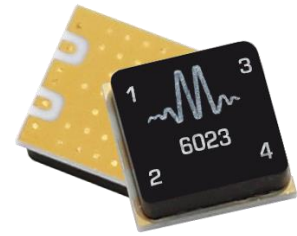

KFN

1.2 Features

- High Frequency Operation
- High LO to RF isolation
- RoHS Compliant

1.3 Applications

- Electronic Warfare Scanners
- 5G Test Receivers

1.4 Functional Block Diagram

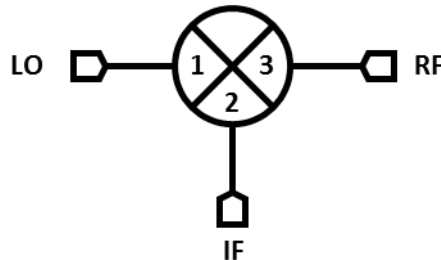

1.5 Part Ordering Options¹

Part Number	Description	Package	Green Status	Product Lifecycle	Export Classification
MM1-1850HSM-2	KFN	SM	RoHS	Active	EAR99
EVAL-MM1-1850H	Connectorized Evaluation Fixture	Eval		Active	EAR99

¹ Refer to our [website](#) for a list of definitions for terminology presented in this table.

Table of Contents

1. Device Overview	1	3.4 Sequencing Requirements.....	4
1.1 General Description	1	3.5 Electrical Specifications	5
1.2 Features	1	3.6 Typical Performance Plots	6
1.3 Applications	1	3.6.1 Typical Performance Plots: IP3 ..	7
1.4 Functional Block Diagram	1	3.6.2 Typical Performance Plots: LO	
1.5 Part Ordering Options.....	1	Harmonic Isolation.....	7
2. Port Configurations and Functions	3	3.6.3 Typical Spurious Performance:	
2.1 Port Diagram	3	Down-Conversion	9
2.2 Port Functions	3	3.6.4 Typical Spurious Performance: Up-	
3. Specifications	4	Conversion	9
3.1 Absolute Maximum Ratings.....	4	4. Operation.....	10
3.2 Package Information.....	4	4.1 Application Circuit	10
3.3 Recommended Operating Conditions	4	4.2 Ports Operation	10
		5. Mechanical Data.....	11
		5.1 SM Package Outline Drawing	11
		5.2 SM Package Footprint	11

Revision History

Revision Code	Revision Date	Comment
-	May 2019	Datasheet Release



2. Port Configurations and Functions

2.1 Port Diagram

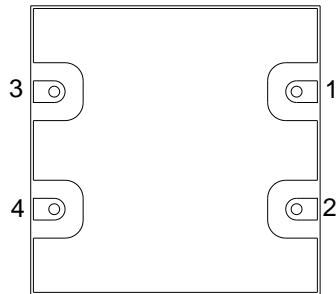
A bottom-up view of the MM1-1850HSM's SM package outline drawing is shown below. The MM1-1850HSM has the input and output ports given in Port Functions. The MM1-1850HSM can be used in either an up or down conversion. For configuration A, input the LO into pin 1, use pin 3 for the RF, and pin 2 for the IF. For configuration B, input the LO into pin 3, use pin 1 for the RF, and pin 2 for the IF.

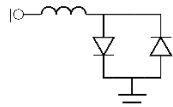

2.2 Port Functions

Port	Function	Description	DC Interface Schematic
Pin 1	LO (Configuration A) RF (Configuration B)	Pin 1 is DC open and AC matched to 50 Ohms from 18 to 50 GHz.	
Pin 2	IF	Port 2 is DC coupled to the diodes. Blocking capacitor is optional.	
Pin 3	RF (Configuration A) LO (Configuration B)	Pin 3 is DC open and AC matched to 50 Ohms from 18 to 50 GHz	
GND	Ground	SM package ground path is provided through the ground paddle.	

3. Specifications

3.1 Absolute Maximum Ratings

The Absolute Maximum Ratings indicate limits beyond which damage may occur to the device. If these limits are exceeded, the device may be inoperable or have a reduced lifetime.

Parameter	Maximum Rating	Units
Power Handling, at any Port	+30	dBm
Operating Temperature	TBD	°C
Storage Temperature	TBD	°C

3.2 Package Information

Parameter	Details	Rating
ESD	Human Body Model (HBM), per MIL-STD-750, Method 1020	1A
Weight	EVAL package	TBD
MSL	J-STD-020	TBD

3.3 Recommended Operating Conditions

The Recommended Operating Conditions indicate the limits, inside which the device should be operated, to guarantee the performance given in Electrical Specifications. Operating outside these limits may not necessarily cause damage to the device, but the performance may degrade outside the limits of the electrical specifications. For limits, above which damage may occur, see Absolute Maximum Ratings.

	Min	Nominal	Max	Units
T _A , Ambient Temperature		+25		°C
LO Input Power	+12		+22	dBm

3.4 Sequencing Requirements

There is no requirement to apply power to the ports in a specific order. However, it is recommended to provide a 50Ω termination to each port before applying power. This is a passive diode mixer that requires no DC bias.

3.5 Electrical Specifications

The electrical specifications apply at TA=+25°C in a 50Ω system. Typical data shown is for a down conversion application with a +18dBm sine wave LO input. Specifications shown for configuration A. Configuration B may be suitable for conversions below 45 GHz.

Parameter		Test Conditions	Min	Typical	Max	Units
RF Frequency Range			18		50	GHz
LO Frequency Range			18		45	
IF Frequency Range			0		21	
Conversion Loss (CL) ²		RF = 18 - 50 GHz LO = 18-45 GHz IF = DC - 0.2 GHz		8.7	11.5	dB
		RF = 18 - 50 GHz LO = 18-45 GHz IF = 0.2 - 21 GHz		11.5		
Noise Figure (NF) ³		RF = 18 - 50 GHz LO = 18-45 GHz IF = DC - 0.2 GHz		10		dB
Isolation	LO to RF	RF/LO = 18 - 50 GHz		39		dB
	LO to IF	IF/LO = 18 - 50 GHz		35		
	RF to IF	RF/IF = 18 - 50 GHz		28		
Input IP3 (IIP3)		RF/LO = 18 - 50 GHz IF = DC - 0.2 GHz		+17		dBm
Output IP3 (OIP3)		RF/LO = 18 - 50 GHz IF = DC - 0.2 GHz		+6		dBm
Input 1 dB Gain Compression Point (P1dB)				+9		dBm

² Measured as a down converter to a fixed 91MHz IF.

³ Mixer Noise Figure typically measures within 0.5 dB of conversion loss for IF frequencies greater than 5 MHz.

3.6 Typical Performance Plots

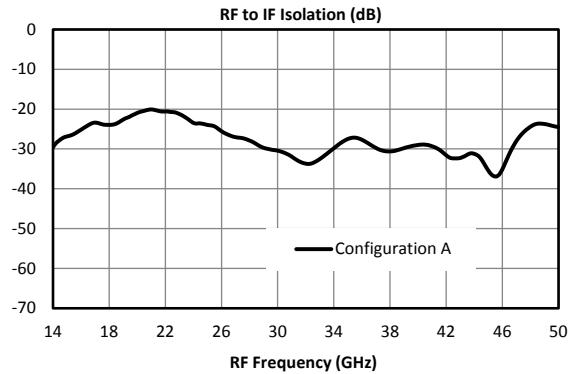
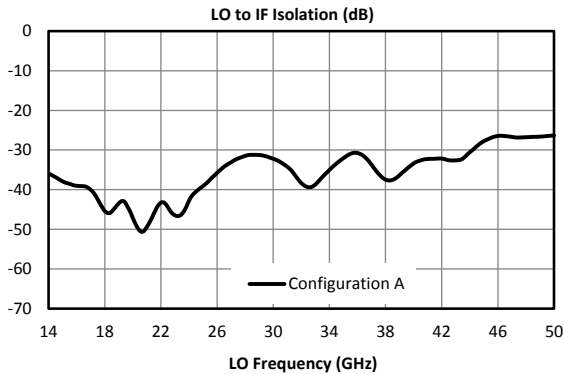
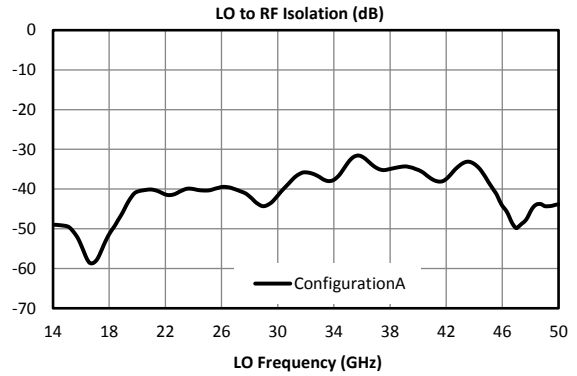
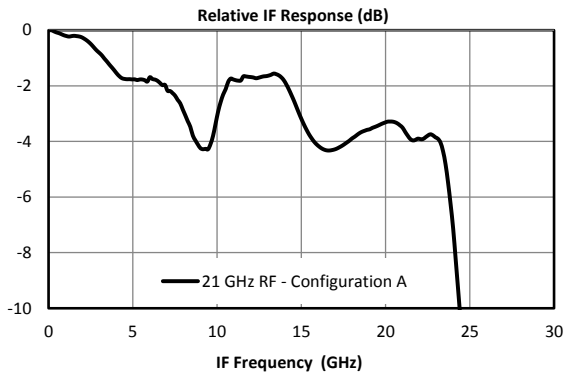
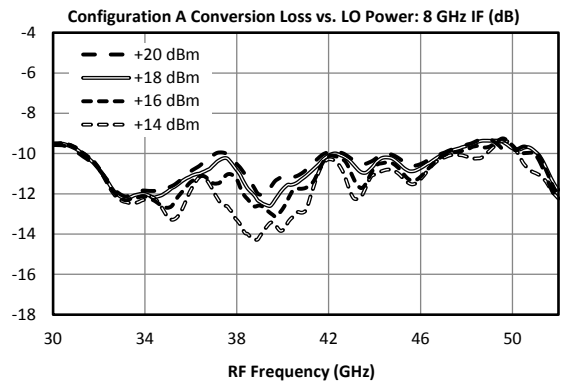
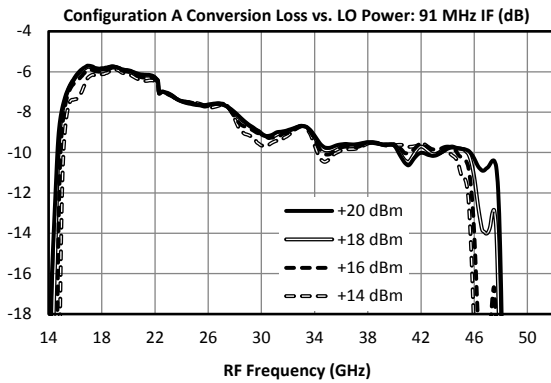
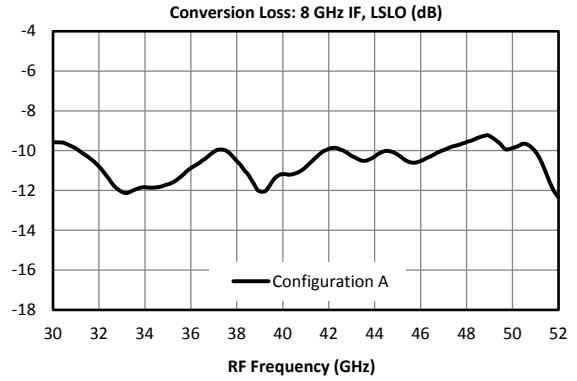
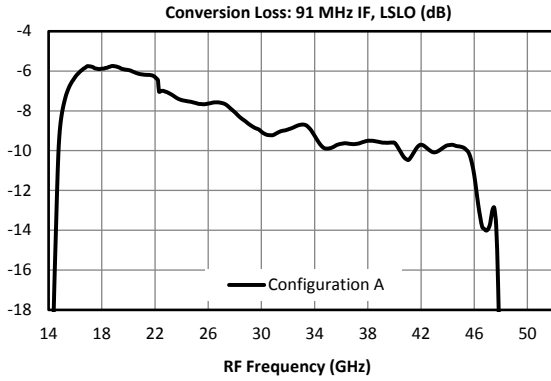

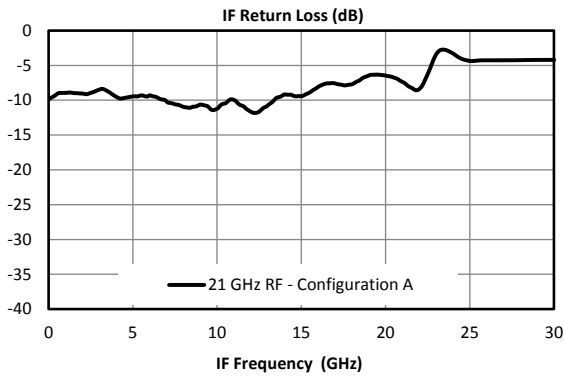
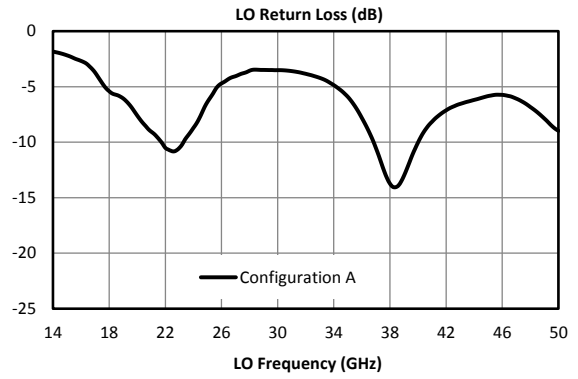
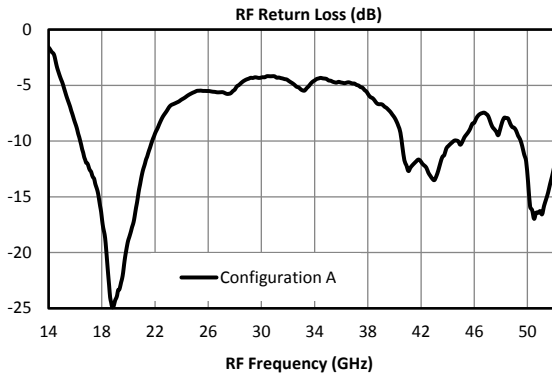

3.6.1 Typical Performance Plots: IP3

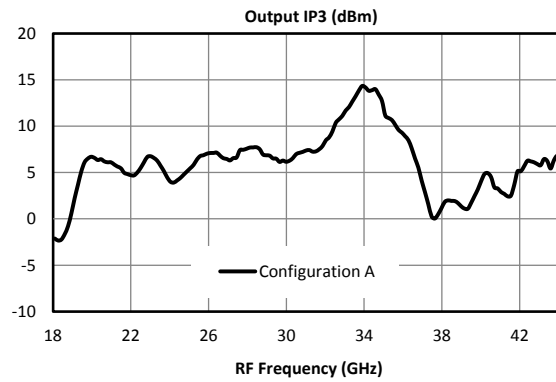
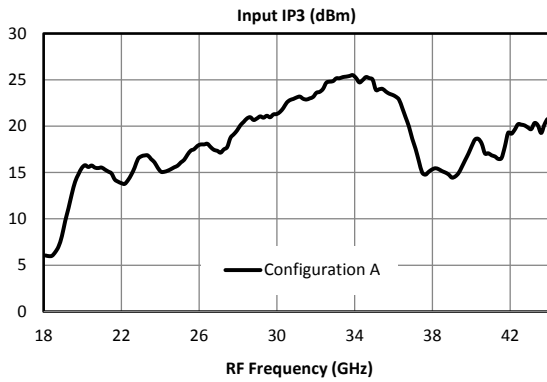

3.6.2 Typical Performance Plots: LO Harmonic Isolation

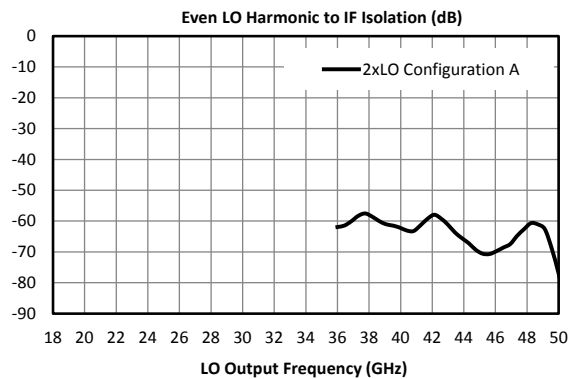
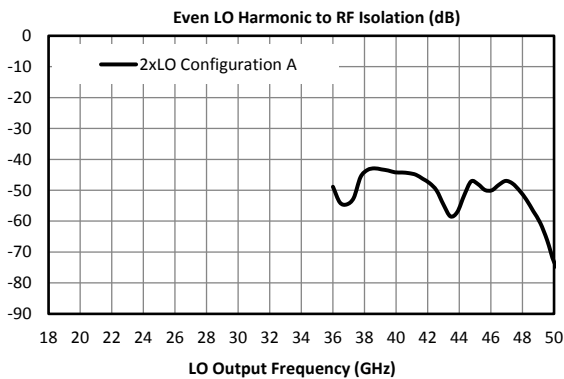

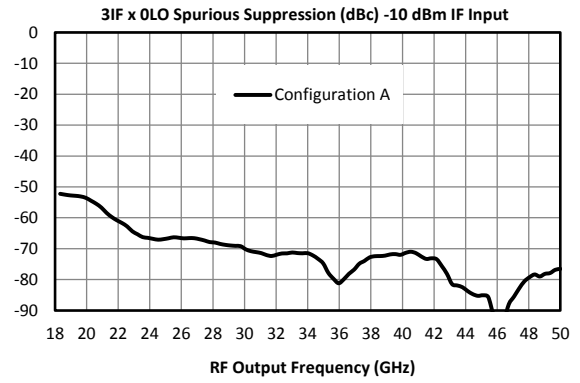
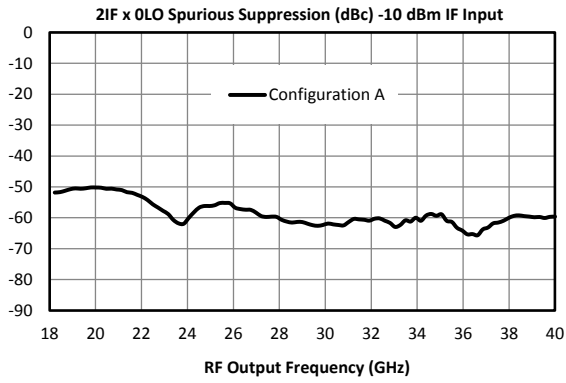
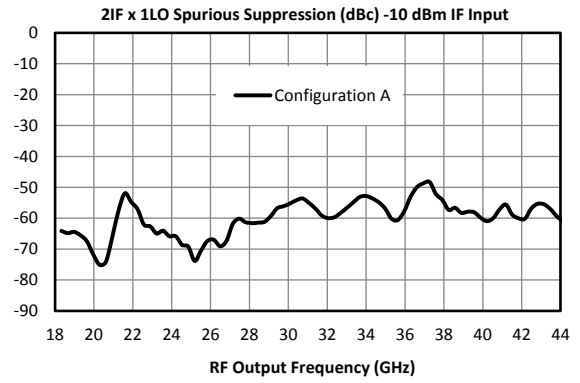
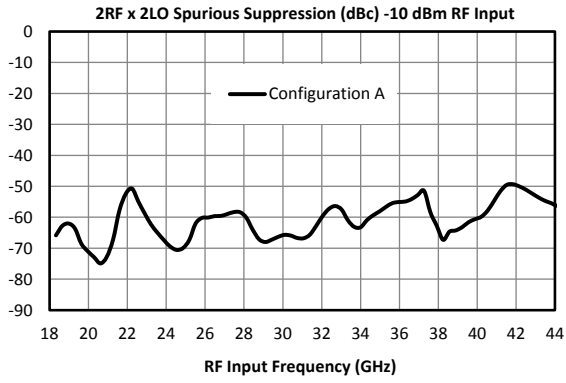

3.6.3 Typical Spurious Performance: Down-Conversion

Typical spurious data is provided by selecting RF and LO frequencies ($\pm m \cdot \text{LO} \pm n \cdot \text{RF}$) within the RF/LO bands, to create a spurious output within the IF band. The mixer is swept across the full spurious band and the mean is calculated. The numbers shown in the table below are for a -10 dBm RF input. Spurious suppression is scaled for different RF power levels by $(n-1)$, where “n” is the RF spur order. For example, the $2\text{RF} \times 2\text{LO}$ spur is 57 dBc for a -10 dBm input, so a -20 dBm RF input creates a spur that is $(2-1) \times (-10 \text{ dB})$ lower, or 67 dBc. Data is shown for the frequency plan in Typical Performance. $m\text{LO} \times n\text{RF}$ plots can be found in section 3.6.2 Typical Performance Plots: LO Harmonic Isolation. $0\text{LO} \times 1\text{RF}$ plot is identical to the plot of LO-RF isolation.

Typical Down-conversion spurious suppression (dBc): Config A

-10 dBm RF Input	0xLO	1xLO	2xLO	3xLO	4xLO	5xLO
0xRF	-	28	54	NA	NA	NA
1xRF	25	Reference	29	12	NA	NA
2xRF	76	43	57	66	68	NA
3xRF	NA	51	73	73	83	79
4xRF	NA	NA	92	100	112	114
5xRF	NA	NA	NA	109	123	121

3.6.4 Typical Spurious Performance: Up-Conversion

Typical spurious data is taken by mixing an input within the IF band, with LO frequencies ($\pm m \cdot \text{LO} \pm n \cdot \text{IF}$), to create a spurious output within the RF output band. The mixer is swept across the full spurious output band and the mean is calculated. The numbers shown in the table below are for a -10 dBm IF input. Spurious suppression is scaled for different IF input power levels by $(n-1)$, where “n” is the IF spur order. For example, the $2\text{IF} \times 1\text{LO}$ spur is typically 57 dBc for a -10 dBm input with a sine-wave LO, so a -20 dBm IF input creates a spur that is $(2-1) \times (-10 \text{ dB})$ lower, or 67 dBc. Data is shown for the frequency plan in Typical Performance.

Typical Up-conversion spurious suppression (dBc): Config A

-10 dBm IF Input	0xLO	1xLO	2xLO	3xLO	4xLO	5xLO
0xIF	-	42	65	NA	NA	NA
1xIF	16	Reference	19	9	NA	NA
2xIF	63	57	57	61	62	NA
3xIF	86	66	73	65	77	66
4xIF	108	102	59	105	98	106
5xIF	116	112	113	115	110	112

4. Operation

4.1 Application Circuit

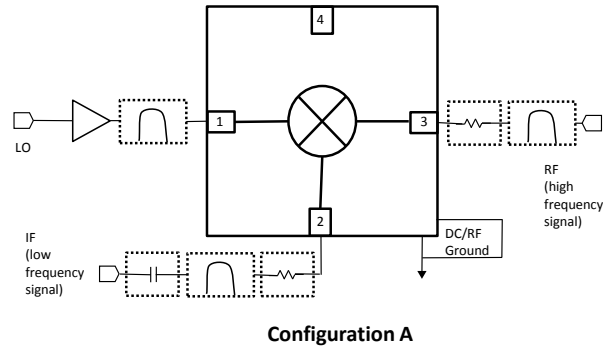

4.2 Ports Operation

IF Port – Used as input on an upconversion, output on downconversion, or LO port in a band shifting application. Signals should be connected by 50 ohm microstrip or coplanar traces to well matched broadband 50 ohm sources and loads. Blocking capacitor is recommended if DC voltage is present on the line.

RF Port – Used as input on a downconversion, output on upconversion, or output in a band shifting application. Signals should be connected by 50 ohm microstrip or coplanar traces to well matched broadband 50 ohm sources and loads.

Filtering and Matching- Filtering is generally desired for spurious and image removal on the output port of the mixer. Reflective filters can cause out of band signals to reflect back into the mixer and cause conversion loss ripple, erroneous spurs, and other undesired behaviors. To eliminate these problems it is recommend that the filters be placed as close to the output port as possible. If undesired behavior is still observed, a diplexer with one port terminated or a 1-3 dB attenuator may reduce this problem.

RF Ground – The ground paddle of the QFN should be connected to a low noise RF ground with very low electrical resistance for high frequency operation.

LO Port – The noise floor of the LO input signal should be less than the value of the noise floor plus isolation of the mixer, or a filter is recommended to prevent reduction in dynamic range. An LO amplifier is required if the LO power is below the recommended drive level. It is important to use an amplifier with a broadband 50 ohm match such that it does not reflect spurious signals back into the mixer or other system circuitry.

5. Mechanical Data

5.1 SM Package Outline Drawing

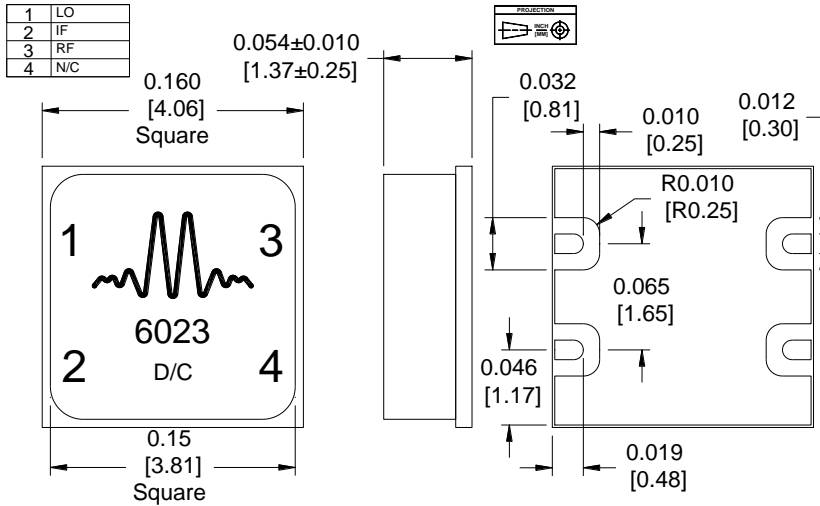

1. Substrate material is ceramic.
2. I/O Leads and Ground Paddle plating is TiW/NiAu, 0.51 μm max Au.
3. All unconnected pads should be connected to PCB RF ground.

5.2 SM Package Footprint

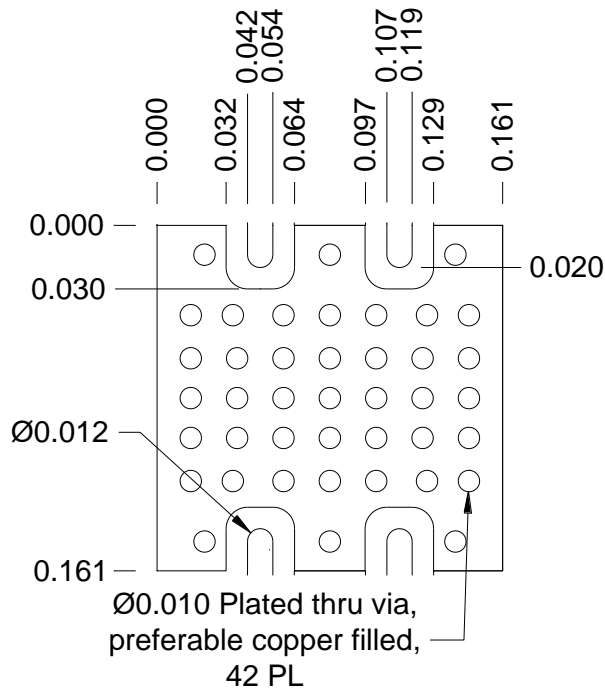

SM-Package Surface-Mount Landing Pattern

[Click here for a DXF of the above layout.](#)

[Click here for leaded solder reflow.](#) [Click here for lead-free solder reflow](#)