

GaAs MMIC Double Balanced Mixer

MM1-0222H

1. Device Overview

1.1 General Description

MM1-0222H is a GaAs MMIC double balanced mixer that features excellent conversion loss, superior isolations and spurious performance across a broad bandwidth. The MM1-0222H works well as both an up and down converter through the Ku band and beyond. The MM1-0222H is recommended for moderate power frequency conversion applications that require high linearity. It is available as both wire bondable die and as connectorized modules. For a list of recommended LO driver amps for all mixers and IQ mixers, see [here](#).



Die



Module

1.2 Features

- High LO to RF isolation
- Up or down conversion
- Broadband performance

1.3 Applications

- Test and measurement equipment
- SATCOM
- Radar
- Electronic Warfare

1.4 Functional Block Diagram

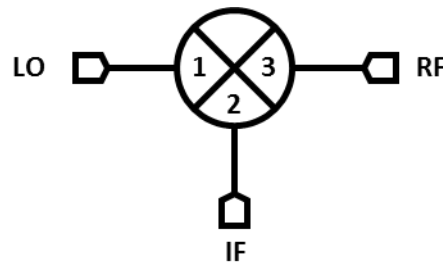

1.5 Part Ordering Options¹

Part Number	Description	Package	Green Status	Product Lifecycle	Export Classification
MM1-0222HCH-2	Wire bondable die	CH	RoHS	Active	EAR99
MM1-0222HS	Connectorized module	S		Active	EAR99

¹ Refer to our [website](#) for a list of definitions for terminology presented in this table.

Table of Contents

1. Device Overview	1	3.6 Typical Performance Plots	6
1.1 General Description	1	3.6.1 Typical Performance Plots: IP3 ..	8
1.2 Features	1	3.6.2 Typical Performance Plots: LO	
1.3 Applications	1	Harmonic Isolation.....	9
1.4 Functional Block Diagram	1	3.6.3 Typical Spurious Performance:	
1.5 Part Ordering Options.....	1	Down-Conversion	10
2. Port Configurations and Functions	3	3.6.4 Typical Spurious Performance: Up-	
2.1 Port Diagram	3	Conversion	10
2.2 Port Functions	3	4. Die Mounting Recommendations	11
3. Specifications	4	4.1 Mounting and Bonding	
3.1 Absolute Maximum Ratings.....	4	Recommendations	11
3.2 Package Information	4	4.2 Handling Precautions	11
3.3 Recommended Operating Conditions .	4	4.3 Bonding Diagram	12
3.4 Sequencing Requirements	4	5. Mechanical Data	13
3.5 Electrical Specifications	5	5.1 CH Package Outline Drawing	13
		5.2 U Package Outline Drawing.....	13

Revision History

Revision Code	Revision Date	Comment
-	September 2019	Datasheet Initial Release
A	March 2020	Power Handling Updated



2. Port Configurations and Functions

2.1 Port Diagram

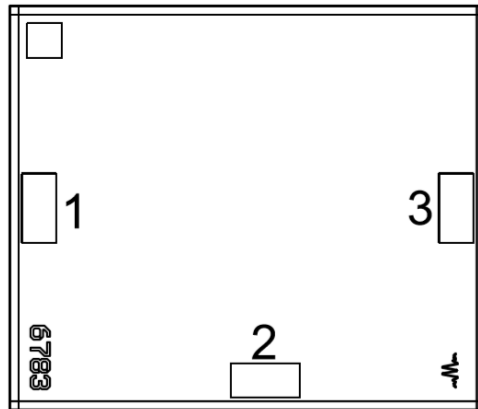
A top-down view of the MM1-0222H's CH package outline drawing is shown below. The MM1-0222H has the input and output ports given in Port Functions. The MM1-0222H can be used in either an up or down conversion. For configuration A, input the LO into port 1, use port 3 for the RF, and port 2 for the IF. For configuration B, input the LO into port 3, use port 1 for the RF, and port 2 for the IF.

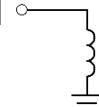
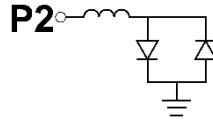
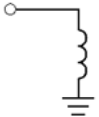

2.2 Port Functions

Port	Function	Description	Equivalent Circuit for Package
Port 1	LO (Configuration A) RF (Configuration B)	Port 1 is DC short for the CH and S packages.	P1 
Port 2	IF	Port 2 is diode connected for the CH and S package.	P2 
Port 3	RF (Configuration A) LO (Configuration B)	Port 3 is DC short for the CH and S packages.	P3 
GND	Ground	CH package ground path is provided through the substrate and ground bond pads. S package ground provided through metal housing and outer coax conductor.	GND 

3. Specifications

3.1 Absolute Maximum Ratings

The Absolute Maximum Ratings indicate limits beyond which damage may occur to the device. If these limits are exceeded, the device may be inoperable or have a reduced lifetime.

Parameter	Maximum Rating	Units
Port 1 DC Current	TBD	mA
Port 2 DC Current	TBD	mA
Port 3 DC Current	TBD	mA
Power Handling, at any Port	+30	dBm
Operating Temperature	-55 to +100	°C
Storage Temperature	-65 to +125	°C

3.2 Package Information

Parameter	Details	Rating
ESD	Human Body Model (HBM), per MIL-STD-750, Method 1020	1A
Weight	S Package	12g

3.3 Recommended Operating Conditions

The Recommended Operating Conditions indicate the limits, inside which the device should be operated, to guarantee the performance given in Electrical Specifications. Operating outside these limits may not necessarily cause damage to the device, but the performance may degrade outside the limits of the electrical specifications. For limits, above which damage may occur, see Absolute Maximum Ratings.

	Min	Nominal	Max	Units
T _A , Ambient Temperature	-55	+25	+100	°C
LO Input Power	+11		+20	dBm

3.4 Sequencing Requirements

There is no requirement to apply power to the ports in a specific order. However, it is recommended to provide a 50Ω termination to each port before applying power. This is a passive diode mixer that requires no DC bias.

3.5 Electrical Specifications

The electrical specifications apply at $T_A=+25^{\circ}\text{C}$ in a 50Ω system. Typical data shown is for the connectorized S package mixer used in the forward direction with a +15 dBm sine wave input. Specifications shown for configuration A (B).

Min and Max limits apply only to our connectorized units and are guaranteed at $T_A=+25^{\circ}\text{C}$. All bare die are 100% DC tested and visually inspected.

Parameter		Test Conditions	Min	Typical	Max	Units
RF (Port 3) Frequency Range			2		22	GHz
LO (Port 1) Frequency Range			2		22	
I (Port 2) Frequency Range			0		3.5	
Conversion Loss (CL) ²		RF/LO = 2 - 22 GHz I = DC - 0.2 GHz		7 (9)	10 (11.5)	dB
		RF/LO = 2 - 22 GHz I = 0.2 - 3.5 GHz		8.5 (10)		
Noise Figure (NF) ³		RF/LO = 2 - 22 GHz I = DC - 0.2 GHz		7		dB
Isolation	LO to RF	RF/LO = 2 - 22 GHz		51		dB
	LO to IF	IF/LO = 2 - 22 GHz		26		
	RF to IF	RF/IF = 2 - 22 GHz		31		
Input IP3 (IIP3)		RF/LO = 2 - 12 GHz I = DC - 0.2 GHz		+20 (+23)		dBm
Input 1 dB Gain Compression Point (P1dB)				+9 (+10)		dBm

² Measured as a down converter to a fixed 91MHz IF.

³ Mixer Noise Figure typically measures within 0.5 dB of conversion loss for IF frequencies greater than 5 MHz.

3.6 Typical Performance Plots

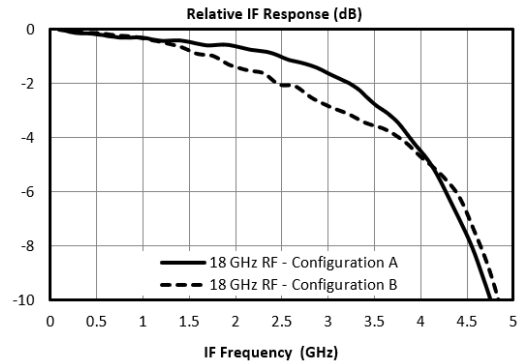
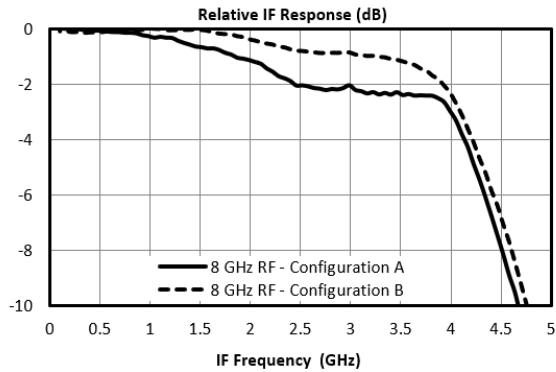
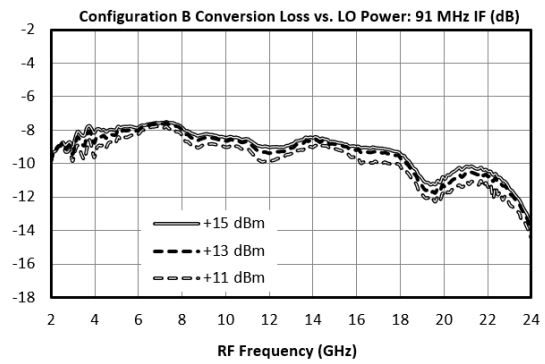
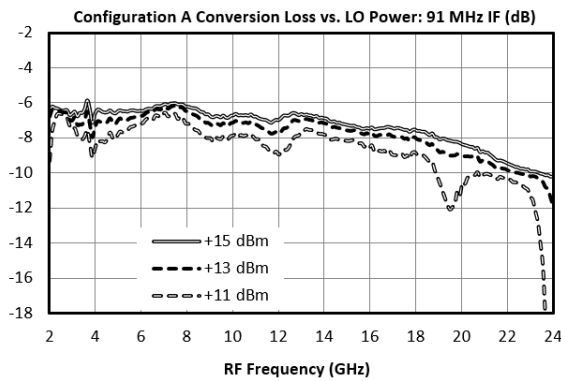
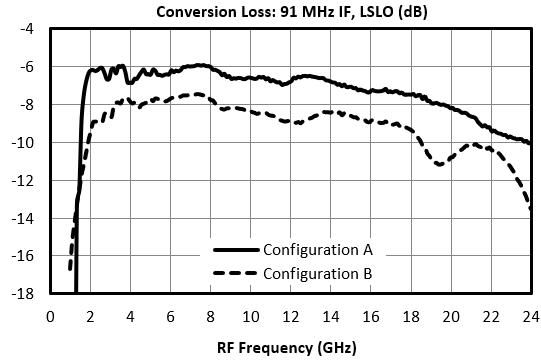

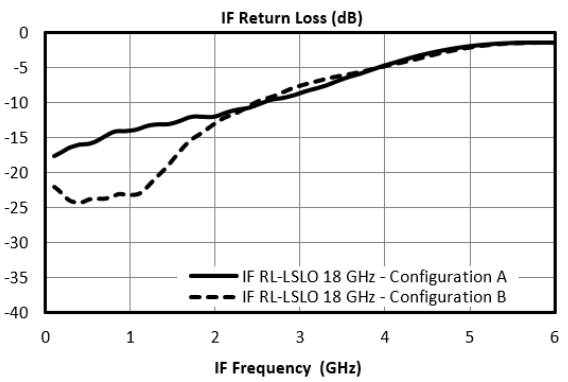
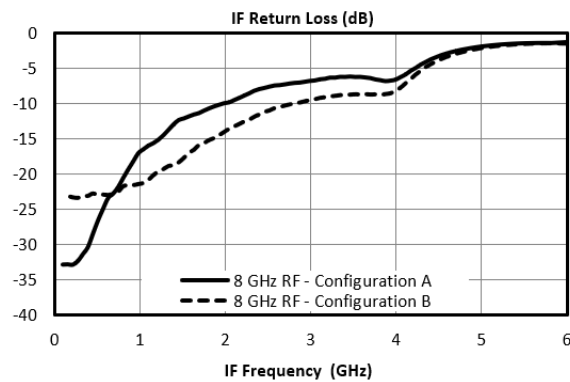
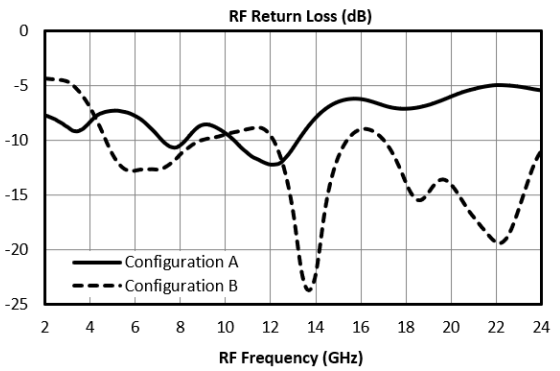
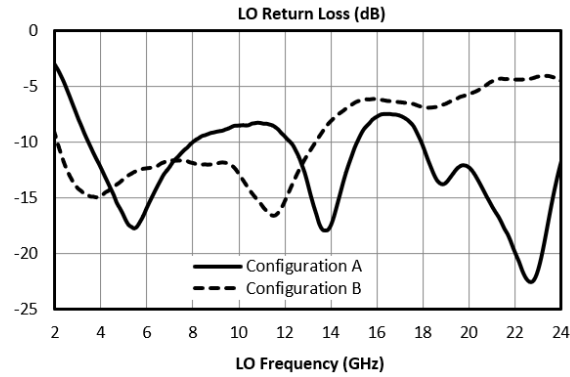
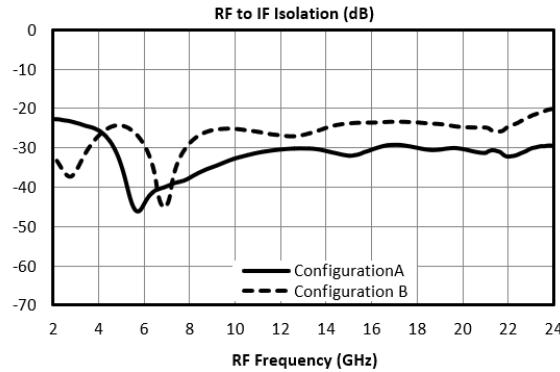
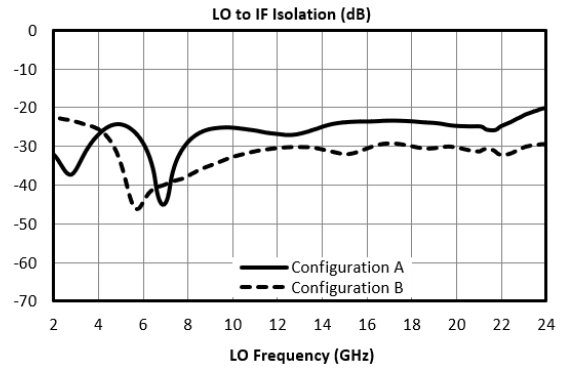
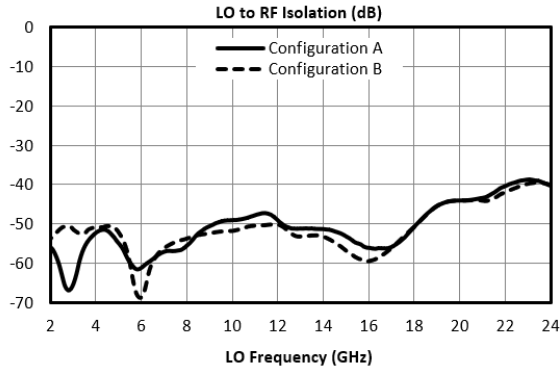

3.6.1 Typical Performance Plots: IP3

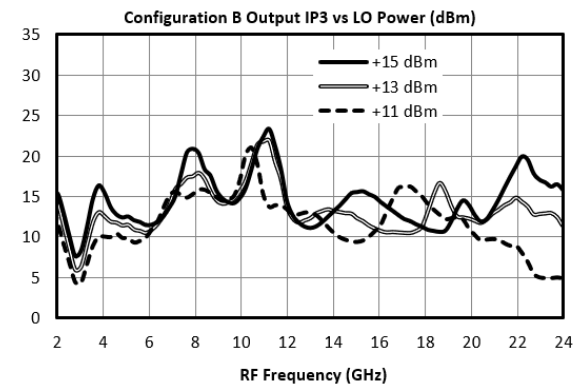
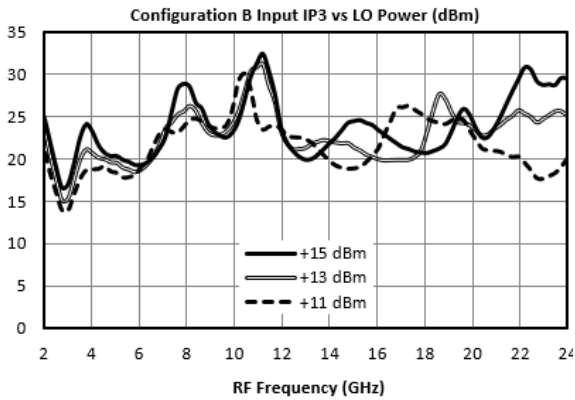
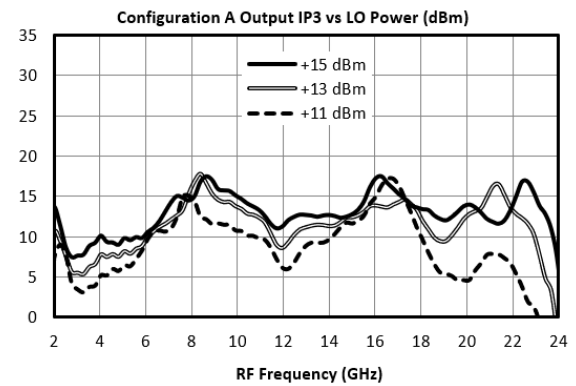
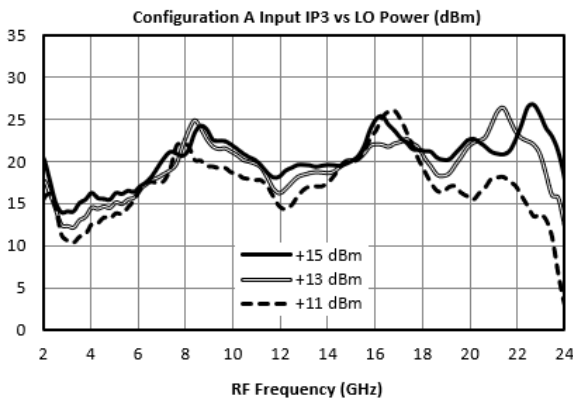
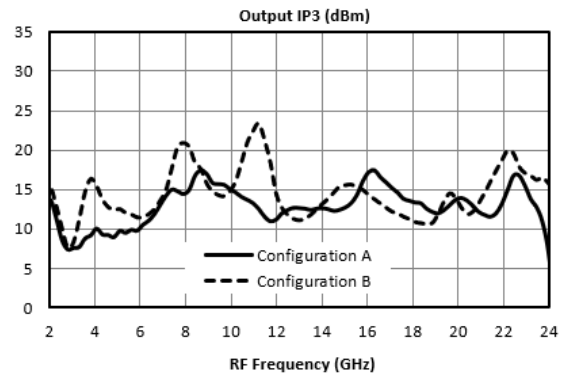
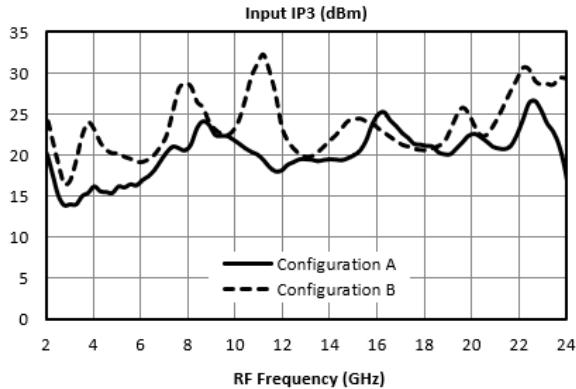

3.6.2 Typical Performance Plots: LO Harmonic Isolation

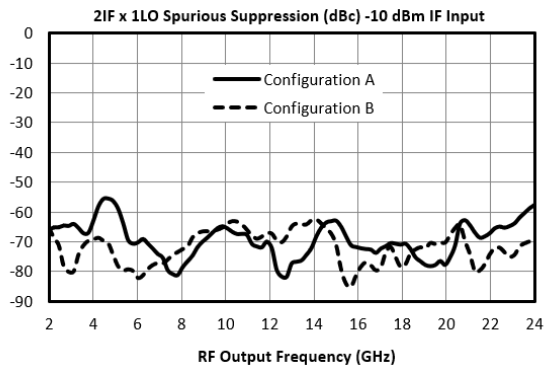
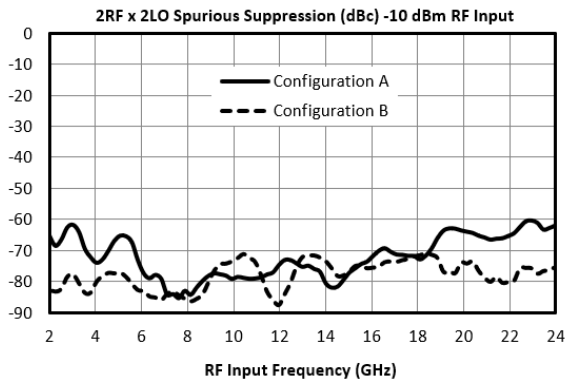
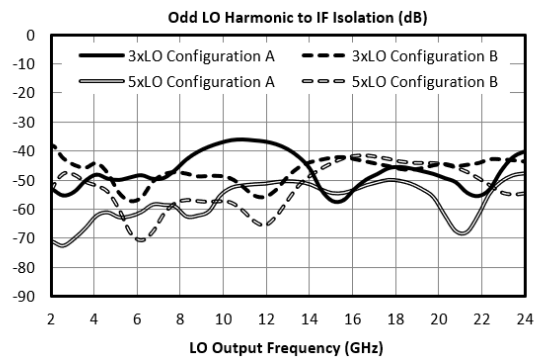
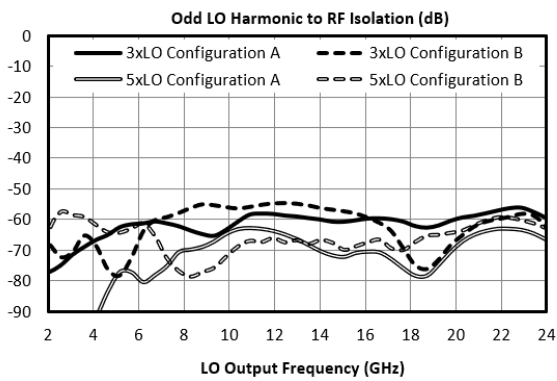
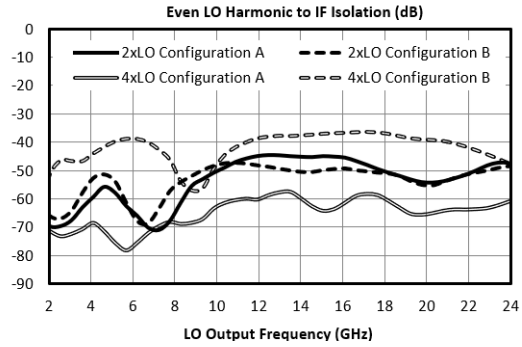
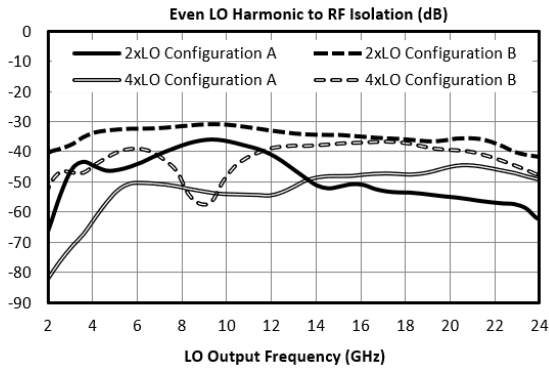

3.6.3 Typical Spurious Performance: Down-Conversion

Typical spurious data is provided by selecting RF and LO frequencies ($\pm m \cdot \text{LO} \pm n \cdot \text{RF}$) within the RF/LO bands, to create a spurious output within the IF band. The mixer is swept across the full spurious band and the mean is calculated. The numbers shown in the table below are for a -10 dBm RF input. Spurious suppression is scaled for different RF power levels by $(n-1)$, where "n" is the RF spur order. For example, the 2RF x 2LO spur is 69 dBc for a -10 dBm input, so a -20 dBm RF input creates a spur that is $(2-1) \times (-10 \text{ dB})$ lower, or 79 dBc. Data is shown for the frequency plan in 3.6 Typical Performance. mLOxORF plots can be found in section 3.6.2 Typical Performance Plots: LO Harmonic Isolation. OLOx1RF plot is identical to the plot of LO-RF isolation.

Typical Down-conversion spurious suppression (dBc): Config A (B)

-10 dBm RF Input	0xLO	1xLO	2xLO	3xLO	4xLO	5xLO
1xRF	20 (16)	Reference	28 (36)	12 (12)	38 (41)	23 (16)
2xRF	66 (73)	53 (51)	69 (78)	60 (56)	70 (74)	59 (53)
3xRF	81 (93)	72 (81)	86 (105)	79 (89)	90 (103)	76 (86)
4xRF	121 (134)	120 (124)	125 (132)	118 (121)	128 (135)	121 (122)
5xRF	138 (153)	134 (142)	134 (150)	131 (143)	137 (149)	130 (144)

3.6.4 Typical Spurious Performance: Up-Conversion

Typical spurious data is taken by mixing an input within the IF band, with LO frequencies ($\pm m \cdot \text{LO} \pm n \cdot \text{IF}$), to create a spurious output within the RF output band. The mixer is swept across the full spurious output band and the mean is calculated. The numbers shown in the table below are for a -10 dBm IF input. Spurious suppression is scaled for different IF input power levels by $(n-1)$, where "n" is the IF spur order. For example, the 2IFx1LO spur is typically 69 dBc for a -10 dBm input with a sine-wave LO, so a -20 dBm IF input creates a spur that is $(2-1) \times (-10 \text{ dB})$ lower, or 79 dBc. Data is shown for the frequency plan in 3.6 Typical Performance.

Typical Up-conversion spurious suppression (dBc): Config A (B)

-10 dBm IF Input	0xLO	1xLO	2xLO	3xLO	4xLO	5xLO
1xIF	26 (17)	Reference	49 (55)	46 (49)	57 (58)	61 (62)
2xIF	56 (55)	69 (72)	57 (50)	64 (71)	50 (46)	67 (68)
3xIF	102 (95)	79 (78)	86 (96)	69 (75)	84 (91)	70 (71)
4xIF	130 (128)	123 (129)	116 (112)	122 (130)	105 (105)	116 (123)
5xIF	148 (158)	128 (131)	136 (148)	117 (125)	127 (140)	109 (119)

4. Die Mounting Recommendations

4.1 Mounting and Bonding Recommendations

Marki MMICs should be attached directly to a ground plane with conductive epoxy. The ground plane electrical impedance should be as low as practically possible. This will prevent resonances and permit the best possible electrical performance. Datasheet performance is only guaranteed in an environment with a low electrical impedance ground.

Mounting - To epoxy the chip, apply a minimum amount of conductive epoxy to the mounting surface so that a thin epoxy fillet is observed around the perimeter of the chip. Cure epoxy according to manufacturer instructions.

Wire Bonding - Ball or wedge bond with 0.025 mm (1 mil) diameter pure gold wire. Thermosonic wirebonding with a nominal stage temperature of 150 °C and a ball bonding force of 40 to 50 grams or wedge bonding force of 18 to 22 grams is recommended. Use the minimum level of ultrasonic energy to achieve reliable wirebonds. Wirebonds should be started on the chip and terminated on the package or substrate. All bonds should be as short as possible <0.31 mm (12 mils).

Circuit Considerations – 50 Ω transmission lines should be used for all high frequency connections in and out of the chip. Wirebonds should be kept as short as possible, with multiple wirebonds recommended for higher frequency connections to reduce parasitic inductance. In circumstances where the chip more than .001" thinner than the substrate, a heat spreading spacer tab is optional to further reduce bondwire length and parasitic inductance.

4.2 Handling Precautions

General Handling

Chips should be handled with care using tweezers or a vacuum collet. Users should take precautions to protect chips from direct human contact that can deposit contaminants, like perspiration and skin oils on any of the chip's surfaces.

Static Sensitivity

GaAs MMIC devices are sensitive to ESD and should be handled, assembled, tested, and transported only in static protected environments.

Cleaning and Storage: Do not attempt to clean the chip with a liquid cleaning system or expose the bare chips to liquid. Once the ESD sensitive bags the chips are stored in are opened, chips should be stored in a dry nitrogen atmosphere.

4.3 Bonding Diagram

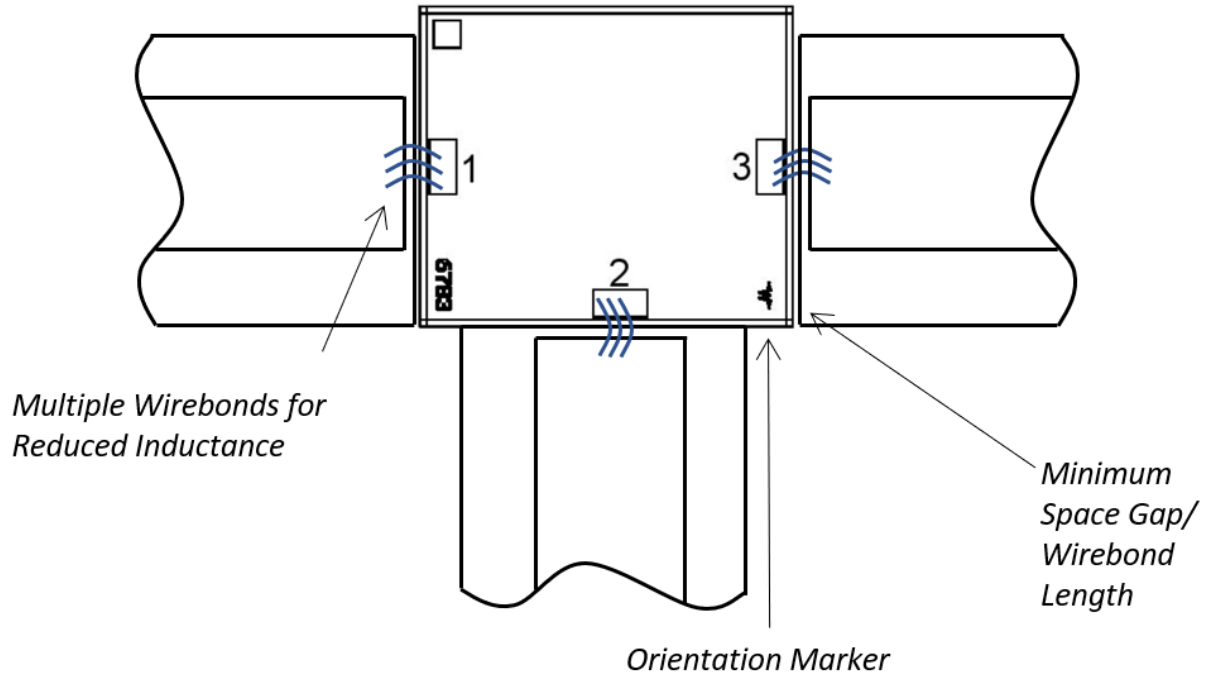

5. Mechanical Data

5.1 CH Package Outline Drawing

Function	Configuration A Port Number	Configuration B Port Number
LO	1	3
IF	2	2
RF	3	1

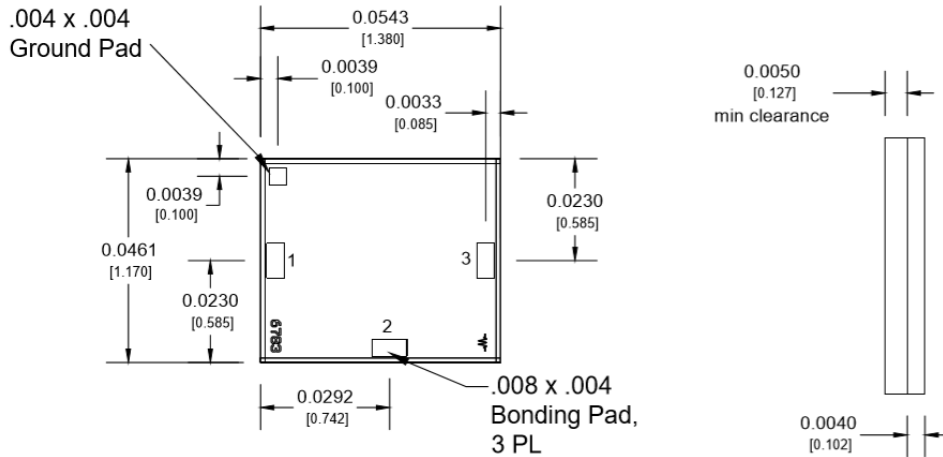
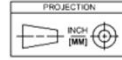

1. CH Substrate material is 0.004 in thick GaAs.
2. I/O trace finish is 4.2 microns Au. Ground plane finish is 5 microns Au.

5.2 S Package Outline Drawing

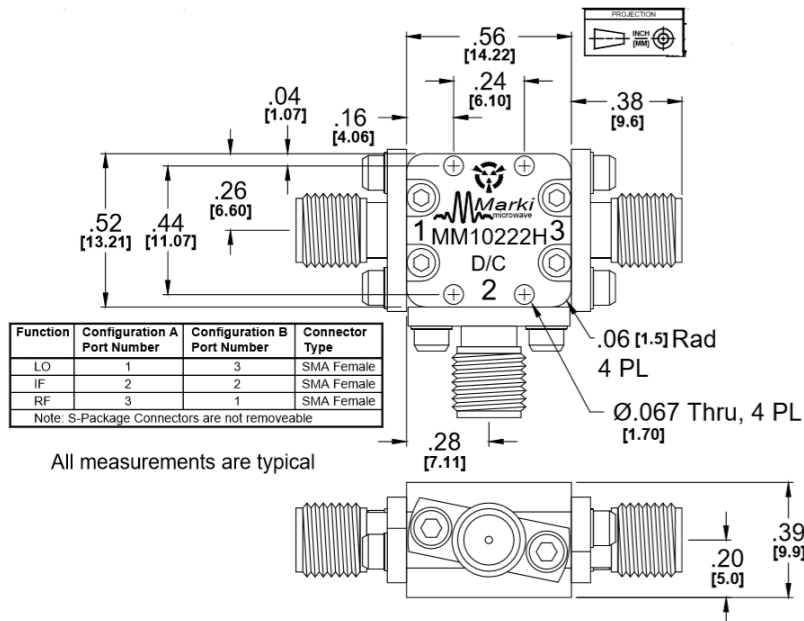

Marki Microwave reserves the right to make changes to the product(s) or information contained herein without notice. Marki Microwave makes no warranty, representation, or guarantee regarding the suitability of its products for any particular purpose, nor does Marki Microwave assume any liability whatsoever arising out of the use or application of any product.