

MICROLITHIC™ DOUBLE-BALANCED MIXER

ML1-0638

The ML1-0638 is a Microlithic™ double balanced mixer. As with all Microlithic™ mixers (patent pending), it features excellent conversion loss, isolations, and spurious performance across a broad bandwidth and in a miniaturized form factor. Accurate, nonlinear software models are available for Microwave Office through the Marki Microwave PDK. The ML1-0638 is available as a wire bondable chip or in a connectorized package. The ML1-0638 is an excellent alternative to Marki Microwave M9 mixers packaged in drop-in carriers such as the ES carrier.



Features

- Compact Chip Style Package (0.152" x 0.090" x 0.015")
- CAD Optimized for Superior Isolation and Spurious Response
- Broadband Performance
- Excellent Unit-to-Unit Repeatability
- Fully nonlinear software models available with Marki PDK for Microwave Office
- RoHS Compliant

Electrical Specifications - Specifications guaranteed from -55 to +100°C, measured in a 50Ω system.

Parameter	LO (GHz)	RF (GHz)	IF (GHz)	Min	Typ	Max	Diode Option LO drive level (dBm)	
Conversion Loss (dB)	6-38		DC-6		8	11		
			6-8		11	14		
Isolation (dB)								
LO-RF						35		
LO-IF						25		
RF-IF				25				
Input 1 dB Compression (dBm)					+3		L (+10 to +13)	
					+9		I (+15 to +19)	
Input Two-Tone Third Order Intercept Point (dBm)					+14		L (+10 to +13)	
					+21		I (+15 to +19)	

Part Number Options

Please specify diode level and package style by adding to model number.				
Package Styles		Examples		
Connectorized ¹	<u>S</u>	ML1-0638LCH-2, ML1-0638LS		
Chip ² (RoHS)	<u>CH-2</u>	<u>ML1-0638</u> (Model)	<u>L</u> (Diode Option)	<u>CH-2</u> (Package)

¹Connectorized package consists of chip package wire bonded to a substrate, equivalent to an evaluation board.

²Chip package connects to external circuit through wire bondable gold pads.

MICROLITHIC™ DOUBLE-BALANCED MIXER

ML1-0638

Page 2

LO/RF 6 to 38 GHz
IF DC to 8 GHz

Typical Performance

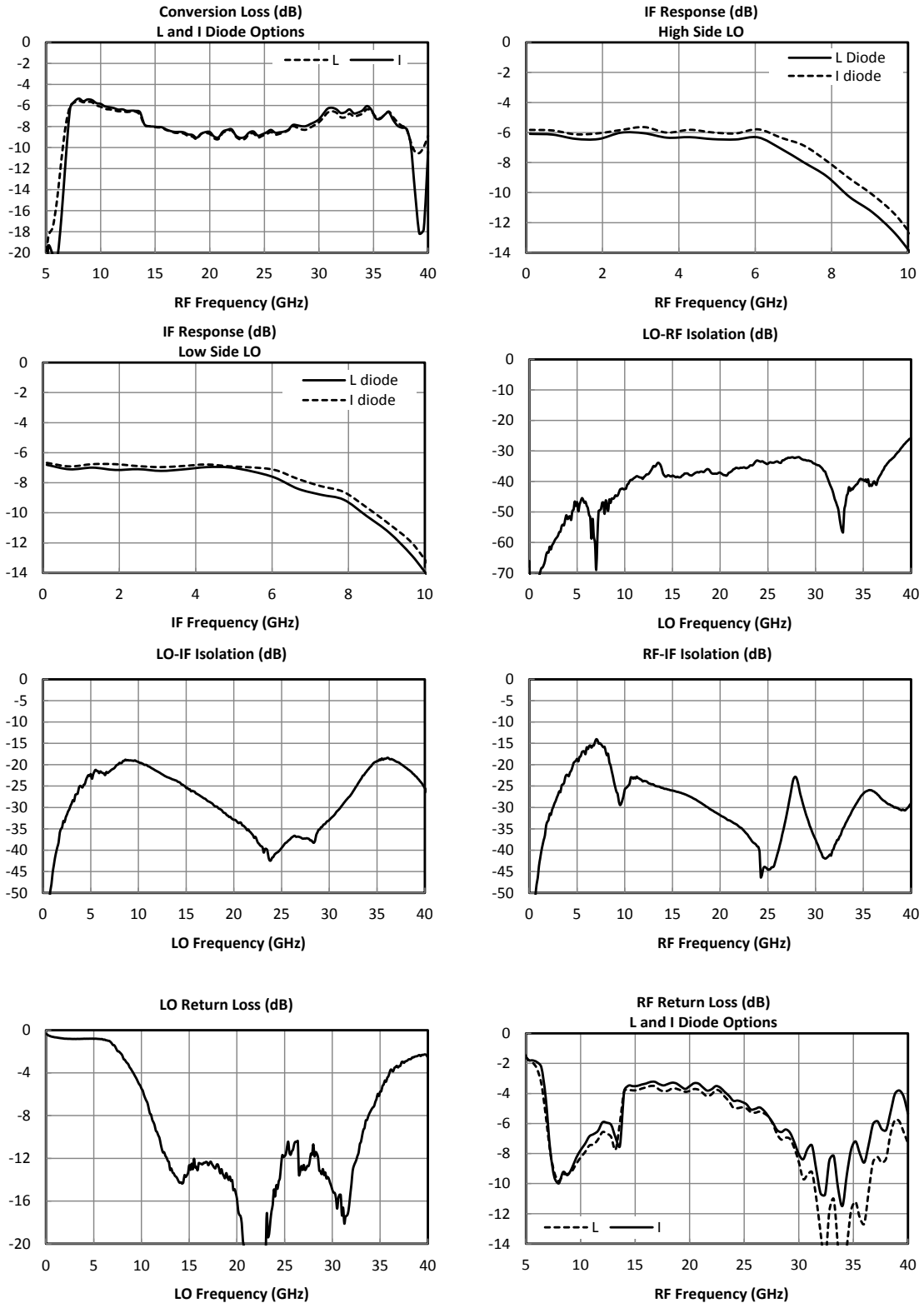

MICROLITHIC™ DOUBLE-BALANCED MIXER

ML1-0638

Page 3

LO/RF 6 to 38 GHz
IF DC to 8 GHz

Typical Performance

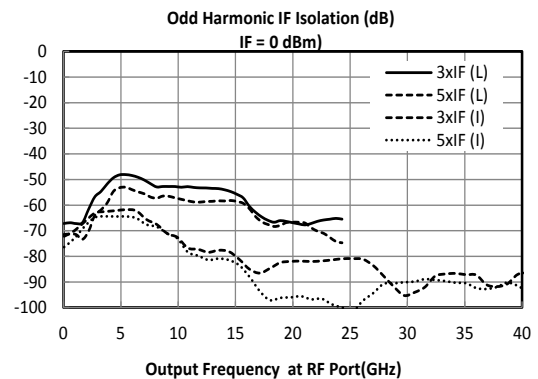
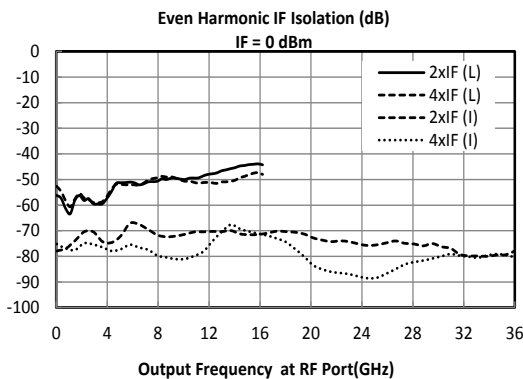
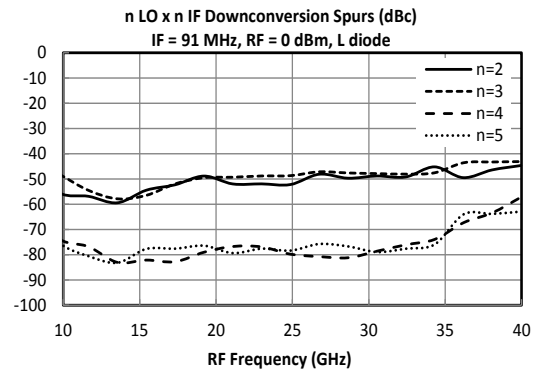
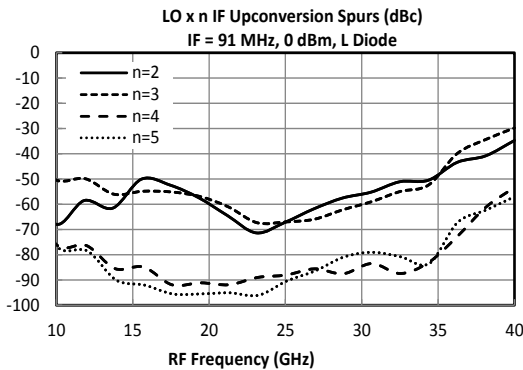
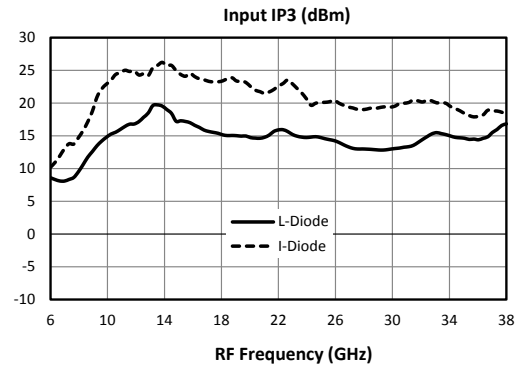
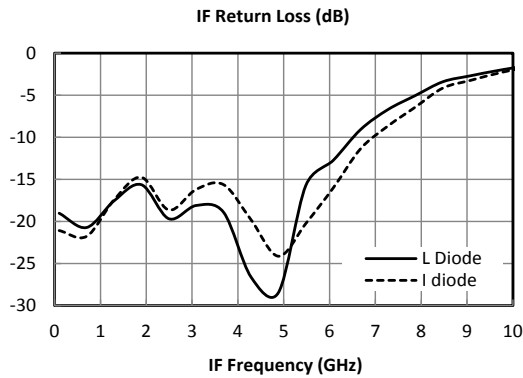

MICROLITHIC™ DOUBLE-BALANCED MIXER

ML1-0638

Page 4

LO/RF 6 to 38 GHz
IF DC to 8 GHz

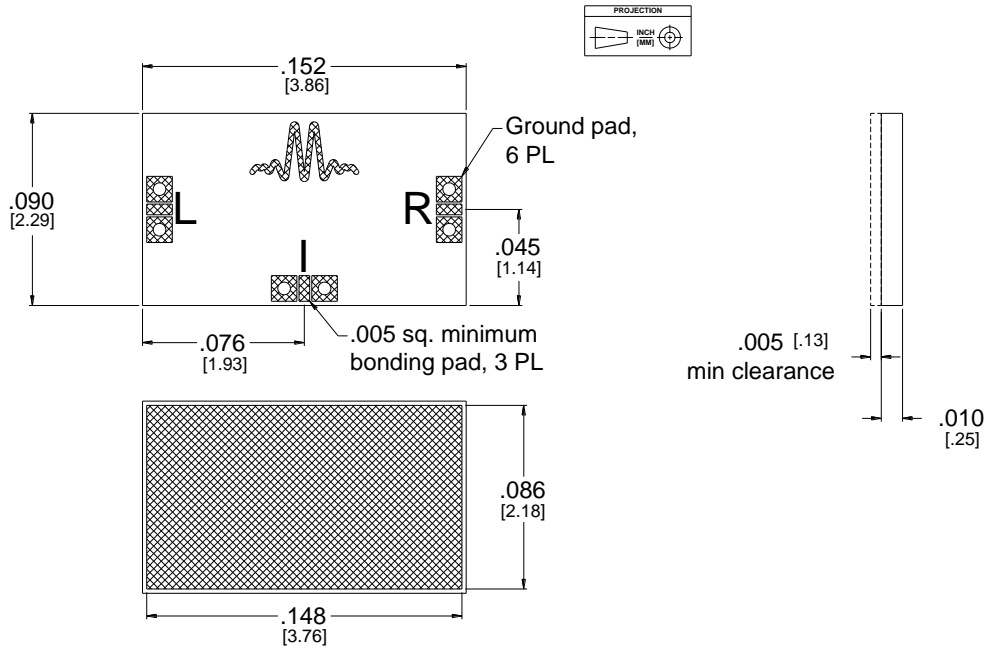

Outline Drawing – CH-2 package

*CH Substrate material is .010 thick Ceramic.

I/O traces and ground plane finish is 2.5 microns Au over .05 microns WTi.

Wire Bonding - Ball or wedge bond with 0.025 mm (1 mil) diameter pure gold wire. Thermosonic wirebonding with a nominal stage temperature of 150 °C and a ball bonding force of 40 to 50 grams or wedge bonding force of 18 to 22 grams is recommended. Use the minimum level of ultrasonic energy to achieve reliable wirebonds. Wirebonds should be started on the chip and terminated on the package or substrate. All bonds should be as short as possible <0.31 mm (12 mils).

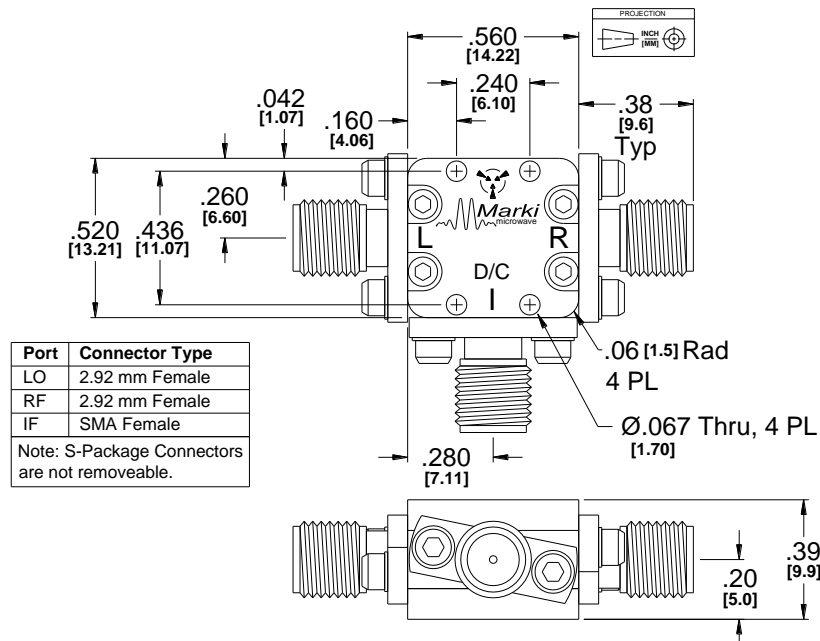

Outline Drawing – S package



MICROLITHIC™ DOUBLE-BALANCED MIXER

ML1-0638

Page 5

**LO/RF 6 to 38 GHz
IF DC to 8 GHz**

Downconversion Spurious Suppression

Spurious data is taken by selecting RF and LO frequencies ($\pm mLO \pm nRF$) within the 6 to 38 GHz RF/LO bands, which create a 100 MHz IF spurious output. The mixer is swept across the full spurious band and the mean is calculated. The numbers shown in the table below are for a -10 dBm RF input. Spurious suppression is scaled for different RF power levels by (n-1), where “n” is the RF spur order. For example, the 2RFx2LO spur is 60 dBc for a -10 dBm input, so a -20 dBm RF input creates a spur that is (2-1) x (-10 dB) dB lower, or 70 dBc.

Typical Downconversion Spurious Suppression (dBc): I diode (L diode) ⁵

-10 dBm RF Input	1xLO	2xLO	3xLO	4xLO	5xLO
1xRF	Reference	23(28)	11(11)	25(37)	18(24)
2xRF	56(57)	60(55)	62(57)	59(59)	65(67)
3xRF	58(53)	77(68)	68(59)	78(69)	71(60)
4xRF	96(92)	101(93)	106(98)	104(93)	104(93)
5xRF	102(95)	115(104)	115(99)	117(109)	114(99)

Upconversion Spurious Suppression

Spurious data is taken by mixing a 100 MHz IF with LO frequencies ($\pm mLO \pm nIF$), which creates an RF within the 6 to 38 GHz RF band. The mixer is swept across the full spurious output band and the mean is calculated. The numbers shown in the table below are for a -10 dBm IF input. Spurious suppression is scaled for different IF input power levels by (n-1), where “n” is the IF spur order. For example, the 2IFx1LO spur is typically 65 dBc for a -10 dBm input, so a -20 dBm IF input creates a spur that is (2-1) x (-10 dB) dB lower, or 75 dBc.

Typical Upconversion Spurious Suppression (dBc): I diode (L diode) ⁵

-10 dBm IF Input	1xLO	2xLO	3xLO	4xLO	5xLO
1xIF	Reference	23(28)	11(12)	24(37)	21(26)
2xIF	65(57)	58(57)	59(59)	48(48)	56(62)
3xIF	72(68)	80(70)	70(61)	71(70)	63(56)
4xIF	109(105)	106(97)	100(97)	92(85)	89(88)
5xIF	120(114)	119(115)	117(102)	109(103)	100(90)



MICROLITHIC™ DOUBLE-BALANCED MIXER

ML1-0638

Page 6

LO/RF 6 to 38 GHz
IF DC to 8 GHz

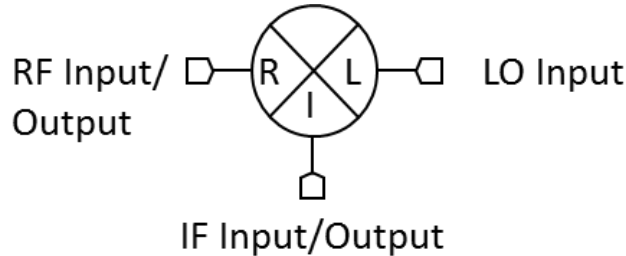

Port	Description	DC Interface Schematic
LO	The LO port is DC short to ground and AC matched to 50 Ohms from 6 GHz to 38 GHz. Blocking capacitor is optional.	
RF	The RF port is DC short to ground and AC matched to 50 Ohms from 6 GHz to 38 GHz. Blocking capacitor is optional.	
IF	The IF port is DC coupled to the diodes. Blocking capacitor is optional.	

Absolute Maximum Ratings	
Parameter	Maximum Rating
RF DC Current	1 Amp
LO DC Current	1 Amp
IF DC Current	50 mA
RF Power Handling (RF+LO)	+25 dBm at +25°C, derated linearly to +20 dBm at +100°C
Operating Temperature	-55°C to +100°C
Storage Temperature	-65°C to +125°C

DATA SHEET NOTES:

- Mixer Conversion Loss Plot IF frequency is 100 MHz.
- Mixer Noise Figure typically measures within 0.5 dB of conversion loss for IF frequencies greater than 5 MHz.
- Conversion Loss typically degrades less than 0.5 dB for LO drives 2 dB below the lowest and 3 dB above highest nominal LO drive levels.
- Conversion Loss typically degrades less than 0.5 dB at +100°C and improves less than 0.5 dB at -55°C.
- Unless otherwise specified L diode data taken with 13 dBm LO drive, I diode data taken with 17 dBm LO drive.
- Specifications are subject to change without notice. Contact Marki Microwave for the most recent specifications and data sheets.
- Catalog mixer circuits are continually improved. Configuration control requires custom mixer model numbers and specifications.

Marki Microwave reserves the right to make changes to the product(s) or information contained herein without notice. Marki Microwave makes no warranty, representation, or guarantee regarding the suitability of its products for any particular purpose, nor does Marki Microwave assume any liability whatsoever arising out of the use or application of any product.

© Marki Microwave, Inc.

